

TRAMPOLINE

INSTALLATION INSTRUCTIONS

- | | |
|---|---------------------------------|
| <input type="checkbox"/> 6'(183 cm) Trampoline | |
| <input type="checkbox"/> 8'(244 cm) Trampoline | <input type="checkbox"/> 3 legs |
| <input type="checkbox"/> 10'(305 cm) Trampoline | <input type="checkbox"/> 4 legs |
| <input type="checkbox"/> 12'(366 cm) Trampoline | <input type="checkbox"/> 5 legs |
| <input type="checkbox"/> 13'(396 cm) Trampoline | <input type="checkbox"/> 6 legs |
| <input type="checkbox"/> 14'(427 cm) Trampoline | |
| <input type="checkbox"/> 15'(457 cm) Trampoline | |
| <input type="checkbox"/> 16'(487 cm) Trampoline | |

- Spring: 36 48 54 60 64 66
 72 80 84 88 90 96
 100 104 108 110 120

READ THIS FIRST !!!

Thank you for purchasing our product

**IN CASE OF MISSING OR BROKEN
PARTS, PLEASE CONTACT PLACE OF
PURCHASE FOR ASSISTANCE.**

⚠ WARNING

- Adequate overhead clearance is essential. A minimum of 24 ft from ground level is recommended. Provide clearance for wires, tree limbs, and other possible hazards.
- Lateral clearance is essential. Place the trampoline away from walls, structures, fences, and other play areas. Maintain a clear space on all sides of the trampoline.
- Place the trampoline on a level surface before use.
- Use the trampoline in a well-lit area. Artificial illumination may be required for indoor or shady areas.
- We are not liable for any injuries that may occur when using the trampoline.

GENERAL SAFETY

● INSTRUCTIONS

BEFORE YOU BEGIN USING YOUR BIG TRAMPOLINE: Read and understand all this information provided to you in this manual. As with all physical sports and activities there is the risk of participants receiving an injury. To ensure your future enjoyment and the prevention of injury, be sure to follow appropriate safety rules and tips.

⚠ WARNING

- ALWAYS CONSULT A DOCTOR/PHYSICIAN BEFORE PERFORMING ANY KIND OF PHYSICAL ACTIVITY.
- ALWAYS CHECK YOUR BIG TRAMPOLINE BEFORE USE, PAYING SPECIFIC ATTENTION TO ALL THE BOLTS, JUMP MAT AND PADS POSITION. DON'T USE IF ANY PARTS ARE MISSING OR LOOK LIKE THEY SHOW WEAR AND TEAR.
- ALWAYS USES THE PROVIDED SAFETY ENCLOSURE WHEN USING THE TRAMPOLINE.
- ALWAYS ENSURE THAT THE TRAMPOLINE IS USED BY ONLY ONE PERSON AT A TIME. ALWAYS ENSURE THAT WHENEVER THE TRAMPOLINE IS USED BY ANYONE AT ANY SKILL LEVEL THAT DO SO UNDER SUPERVISION.
- Trampolines over 20 in. (51 cm) tall are not recommended for use by children under 6 years of age.
- If a trampoline ladder is used, the supervisor should remove it from the trampoline when leaving the area to prevent unsupervised access by children under 6 years of age.
- For additional information concerning the trampoline equipment, contact the manufacturer.
- Bounce only when the surface of the bed is dry. Wind or air movement should be calm to gentle. The trampoline must not be used in gusty or severe winds.
- Do not attempt or allow somersaults. Serious injuries, paralysis, or death may result.
- Do not allow more than one person on the trampoline at a time.
- Use trampoline only with mature, knowledgeable supervision.
- Not recommended for children under 6 years of age.
- Inspect before use. Keep frame padding in place.
- Climb on and off the trampoline. Do not use the trampoline as a springboard.
- Stop bounce by flexing knees as feet come in contact with the bed.
- Learn fundamental bounces and body positions thoroughly.
- Avoid bouncing too high. Maintain control.

- While keeping the head erect, focus eyes on the trampoline toward the perimeter.
 - Bounce in the center of the bed.
 - Avoid bouncing when tired.
 - Secure the trampoline against unauthorized use
 - Keep objects away which could interfere with the performer.
 - Do not use the trampoline while under the influence of alcohol or drugs.
 - For equipment information, contact the manufacturer.
 - For skill training information, contact a trainer certification organization.
 - Do not use when trampoline is wet or in windy conditions.
 - Read instructions before use.
-
- Stop exercising immediately should you feel unwell or if you feel pain in your joints and muscles. Dizziness is a sign of fatigue and you should stop bouncing and lay down on the ground should you feel dizzy.
-
- When using this trampoline ensure appropriate clothing is worn, preferably sports wear and socks .NEVER WEAR SHOES ON THE MAT.
-
- Please be warned that trampoline is spring based and will allow the user to jump to a greater height than that on the ground, so please bear this in mind and ensure that you are comfortable bouncing at low heights first.
-
- Proper assembly, care and maintenance of product, safety tips, warnings, and proper techniques for jumping on your trampoline are included in this manual for your safety and an extended product life span. All users and supervisors should therefore familiarize themselves with these instructions. Anybody who chooses to use the trampoline must be aware of their own limitations with regards to performing skills on this trampoline.
-
- The safety enclosure is there to prevent the user falling off the trampoline, and is not to be jumped into unnecessarily.
-
- Trampoline should be assembled on grass or BSI approved safety matting.

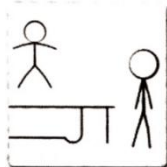
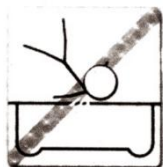

INFORMATION ON THE

● USE OF TRAMPOLINE

- Inspect the trampoline enclosure before each use. Make sure the barrier and the enclosure support (frame) padding is correctly and securely positioned. Replace any worn, defective, or missing parts.
- Users may become entangled in or strangled by loose cords or in gaps between trampoline and enclosure.
- Keep enclosure tightly fastened to the trampoline in accordance with the manufacturer's instructions. Failure to properly assemble and maintain a tight, secure trampoline/ enclosure boundary may result in serious injury, strangulation, or death.
- Do not attempt to jump over the barrier.
- Do not intentionally rebound off the barrier.
- Do not hang from, kick, cut, or climb on the barrier.
- Wear clothing free of drawstrings, hooks, loops or anything that could get caught while using the trampoline/ enclosure and result in entanglement or strangulation, or both.
- Do not attach anything to the barrier that is not a manufacturer-approved accessory or part of the enclosure system.
- Enter and exit the enclosure only at the enclosure door or barrier opening designated for that purpose.

INITIALLY, you should get accustomed to your trampoline and understand how much spring is in each bounce .The focus at this point should be body position and technique until each skill can be completed with ease and control.



- **BEFORE YOU TRY TO JUMP TOO HIGH** the technique for stopping should be learnt as this will help prevent injury should you feel you are jumping out of control.
- As the user lands on the bed knees should be bent so that they stop and absorb the spring in the mat. The position is shown in the image to the left. Arms are held out for increased level of balance.
- **This skill is used when the trampoline user wishes to stop bouncing on the trampoline due to fatigue, loss of control, etc.**



SOMERSAULTS (FLIPS): DO NOT PERFORM somersaults of any type (backwards or forwards) on this trampoline. If you make a mistake when trying to perform a somersault, you could land on your head or neck. This will increase your chances of your neck or back being broken, which could result in death or paralysis.



FOREIGN OBJECTS : DO NOT use the trampoline if there are pets, other people, or any objects underneath the trampoline. This will increase the chances of an injury occurring, DO NOT hold any foreign objects in your hand and DO NOT place any objects on the trampoline while in use. DO NOT place the trampoline under over-hanging objects like tree branches, wires, etc as these will increase your chances of being injured.



POOR MAINTENANCE OF TRAMPOLINE: A trampoline in poor condition will increase your risk of being injured. Please inspect the trampoline before each use for bent steel tubes, torn mat, loose or broken springs and overall stability of the trampoline.



WEATHER CONDITIONS: Please be aware of the weather conditions when using the trampoline. If the mat of the trampoline is wet, the user could slip and injure himself or herself. If it is too windy, the user could lose control.



RESTRICTING ACCESS: When the trampoline is not in use, always store the access ladder in a secure place so that unsupervised children can not play on the trampoline.

TIPS TO REDUCE THE

● RISK OF ACCIDENTS .

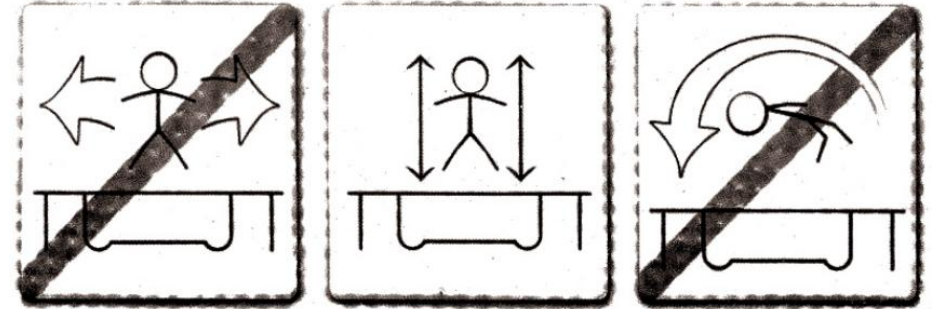

▲WARNING

In order to reduce the risk of accident the “TRAMPOLINE USER” should:

- Always remain in control of their jumps and body position at all times.
- Not attempt to perform skills that are beyond their own level of competence.
- Read and understand the jump by taking off and landing in the middle of the trampoline.
- Always control their jump by taking off and landing in the middle of the trampoline.
- Always jump vertically and refrain from bouncing towards the springs in any direction.
- Always consult a professionally certified trampoline instructor before attempting anything beyond basic techniques.

In order to reduce the risk of accident the “SUPERVISOR” should:

- Fully understand and enforce all the safety rules and guidelines.
- Advise the trampoline user and provide knowledge in what they are doing right and wrong to ensure the safety of trampoline user.
- Be aware and advise the trampoline user of all the safety warnings.

▲WARNING

IMPORTANT: If the Trampoline can not be supervised there should be a method for securing it and preventing anyone from using the product until supervision is available.

TRAMPOLINE

● SAFETY INSTRUCTIONS

ADVISORY PRECAUTIONS WHILE USING THE TRAMPOLINE

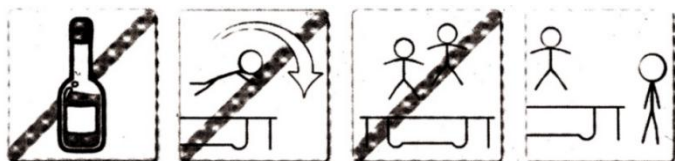

▲ WARNING

- Do not use trampoline if you have consumed alcohol or narcotic substances.
- You should climb on and off the trampoline in a controlled and careful manner. Never jump onto or off the trampoline and never use the trampoline as a means to bounce onto or into another object.
- Always learn the basic bounce and master each type of bounce before trying more difficult types of bounces. Review the basic skills section to learn how to do the basics.
- To stop your bounce, flex your knees when you land on your feet.
- Always be in control when you are bouncing on the trampoline. A controlled jump is when you land at the same spot that you took off from. If at any time you feel out of control, stop bouncing immediately.
- Do not jump or bounce for prolonged periods of time or too high for a number of jumps. Keep your eyes on the mat to maintain control. If you do not, you could lose your balance.
- Never have more than 1 person on the trampoline at any one time.
- Do not attempt or allow somersaults. Landing on the head or neck can cause serious injury, paralysis, or death, even when landing in the middle of the bed.
- Do not allow more than one person on the trampoline. Use by more than one person at the same time increases the chance of injury.
- Use trampoline only with mature, knowledgeable supervision.

▲ WARNING

ADVISORY PRECAUTIONS WHILE SUPERVISING TRAMPOLINE

IMPORTANT: Familiarise yourself with the basic jumps and safety rules. To prevent and reduce the risk of injuries, ensure that all safety rules are enforced and the new users learn the basic bounces before trying more advanced techniques.

- ALL USERS need to be supervised, regardless of skill level or age.
- Never use the trampoline when it is wet, damaged, dirty or worn out. The trampoline should be inspected before use.
- Keep all objects that could interfere during use away from the trampoline at all times. Be aware of what is overhead, underneath and around the trampoline.
- To prevent unsupervised and unauthorized use, the trampoline should be secured at all time.

ACCIDENT

▲ WARNING

● CLASSIFICATION & IDENTIFICATION

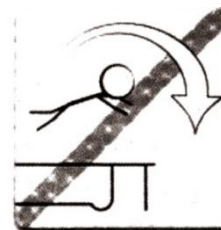

MOUNTING AND DISMOUNTING:

Be very careful when getting on and off the trampoline. DO NOT mount the trampoline by grabbing the frame pad, stepping onto the springs or by jumping onto the mat of the trampoline from an object (eg. A deck, roof, or ladder). This is considered highly dangerous. DO NOT dismount by jumping off the trampoline and landing on the ground. If small children are playing on the trampoline, they may need help in mounting and dismounting.



USE OF ALCOHOL OR DRUGS:

DO NOT consume any alcohol or take any drugs (this includes medication that could affect the user's co-ordination) when using this trampoline. This is considered highly dangerous since these foreign substances impair your judgements, reaction time and overall physical co-ordination.

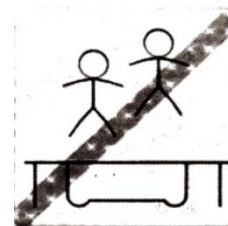

MULTIPLE USERS:

If you have multiple users (more than one person on the trampoline at any one time), you increase the chance of being injured. Injuries can occur when you fly off the trampoline, lose control, collide with other jumper(s), or land on the springs.



STRIKING THE SPRING FRAME:

When playing on the trampoline, STAY in the centre of the trampoline mat. This will reduce the risk of being injured by landing on the spring frame. Always keep the frame pads covering the frame of the trampoline. DO NOT jump or step onto the frame pad directly since it is not intended to support the weight of a person.



LOSS OF CONTROL:

DO NOT try difficult manoeuvres until you have mastered the basics. If you do not follow these guidelines, you increase the risk of someone being injured.

TRAMPOLINE TECHNIQUES

● BASIC SKILLS

BASIC SKILL1: The Basic Bounce

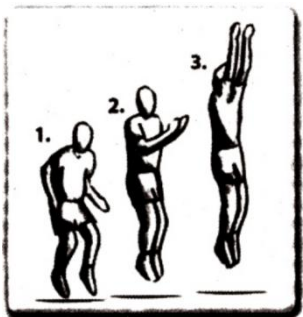

- Start from a standing position, with feet shoulder width apart head up and eyes on the trampoline bed.
- Swing arms forward and up above head in a circular motion.
- Bring legs and feet together in " mid-air " position and point toes
- Land back on the mat with feet shoulder width apart (same as start position).
- Why not try moving onto the next skill once comfortable and proficient.

BASIC SKILL 2: The Knee Drop

- Start with a low basic bounce (as detailed in BASIC SKILL 1).
- Land on knees shoulder width apart, keeping back straight and a strong body position using arms out to the side or in front to maintain balance.
- Bounce back to basic bounce position by using bounce momentum and swinging arms above head.
- Once mastered at this height try bouncing a little higher, but remember to always stay in control of your height.



BASIC SKILL 3: The Seat Drop



- Start with a low basic bounce (BASIC SKILL 1) in the normal position.
- Land with legs out straight in front of you, with hands either side of your hips and back straight in a strong body position.
- Use the bounce momentum aided with a push from hands to return to a standing position.
- Once mastered at this height try bouncing a little higher, but remember to always stay in control of your height.

▲ WARNING

IMPORTANT: Please consult a trained trampoline instructor before attempting any more advanced skills to ensure highest possible safety levels are maintained.

TRAMPOLINE TECHNIQUES

● ADVANCED SKILLS

ADVANCED SKILL 1: The Basic Bounce



- Start with a low basic bounce (BASIC SKILL1) in the normal position
- Land on your hands and knees at the same time, ensure that back is horizontal to the bounce mat and hands & legs are shoulder width apart also.
- Use the momentum of bounce and push off hands to regain the standing position.
- Once mastered at this height try bouncing a little higher, but remember to always stay in control of your height.
- Try moving onto the next skill once comfortable and proficient.

ADVANCED SKILL 2: Hands and Knees to Front Drop

- Land on your hands and knees at the same time, ensure the back is horizontal to the bounce mat and hands & legs are shoulder width apart also.
- Maintain strong body position with back horizontal to mat and straighten legs behind and fold arms in front of face in mid-air ready to land on the mat in a lying down position.
- Ensure the landing is done with all of body touching the mat at same time.
- Push off hands and recover the standing position.
- Once mastered at this height try bouncing a little higher, but remember to always stay in control of your height .Trying moving onto the next skill once comfortable and proficient.

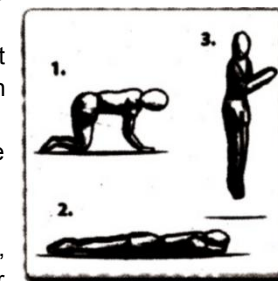

ADVANCE SKILL3: The Front Drop

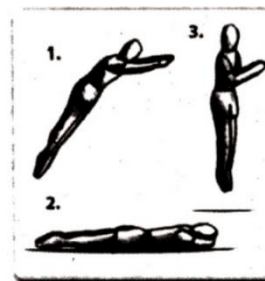

- Start with a low basic bounce (BASIC SKILL 1) in the normal position.
- Maintain strong body position with back horizontal to mat and straighten legs behind and fold arms in front of face in mid-air ready to land on the mat in a lying down position.
- Ensure the landing is done with all of body touching the mat at the same time.
- Push off hands and recover the standing position.
- Once mastered at this height try bouncing a little higher, but remember to always stay in control of your height.

⚠WARNING

IMPORTANT: Should you wish to progress any further and learn more advanced techniques for trampoline, please consult a qualified and registered instructor.

TRAMPOLINE ASSEMBLY

⚠WARNING

- **STEP BY STEP CONSTRUCTION**
- **Only assemble by adult.**

To assemble this trampoline all you need is our special spring loading tool provided with this product.

During periods of non-use. This trampoline can be easily disassembled and stored.

Please read the assembly instructions before beginning to assemble the product.

Please refer to the table for part descriptions and numbers. The assembly instruction use these descriptions and numbers as reference.

Make sure you have all parts listed. If you are missing any parts, please contact place of purchase.

Please use gloves to protect your hands from pinch points during assembly. When you are ready to start, make sure that you have plenty of space and a clean dry area for assembly.

⚠WARNING

PARTS LIST

Trampolines with three or four legs

Ref. Number	Part Number	Description	Unit	6'	8'	10'	12'	13'	14'
1	TR800	Trampoline Mat, stitched with V-Rings	Pcs	1	1	1	1	1	1
2	TR801	Frame Pad	Pcs	1	1	1	1	1	1
3	TR802	Top Rail with leg	Pcs	6	6	8	8	8	8
4	TR803	Leg Base	Pcs	3	3	3or	4	4	4
5	TR804	Vertical Leg Extension	Pcs	0	0or	6or	8	8	8
6	TR805	Springs	Please check the instruction cover						
7	TR806	Safety Instruction	Pcs	1	1	1	1	1	1
8	TR807	spring tool	Pcs	1	1	1	1	1	1
9	TR808	Screw for legs	Pcs	6	6	8	8	8	8

OTHER ITEMS - Trampolines with six legs

Ref. Number	Part Number	Description	12'	13'	14'	15'	16'
1	TR800	Trampoline Mat, stitched with V-Rings	1	1	1	1	1
2	TR801	Frame Pad	1	1	1	1	1
3	TR802	Top Rail with leg	12	12	12	12	12
4	TR803	Leg Base	6	6	6	6	6
5	TR804	Vertical Leg Extension	12	12	12	12	12
6	TR805	Springs	Please check the instruction				
7	TR806	Safety Instruction	1	1	1	1	1
8	TR807	spring tool	1	1	1	1	1
9	TR808	Screw for legs	12	12	12	12	12

Enclosed are the current specifications and product features available at time of printing, however, changes may be made in equipment, availability, specifications and features without notice.

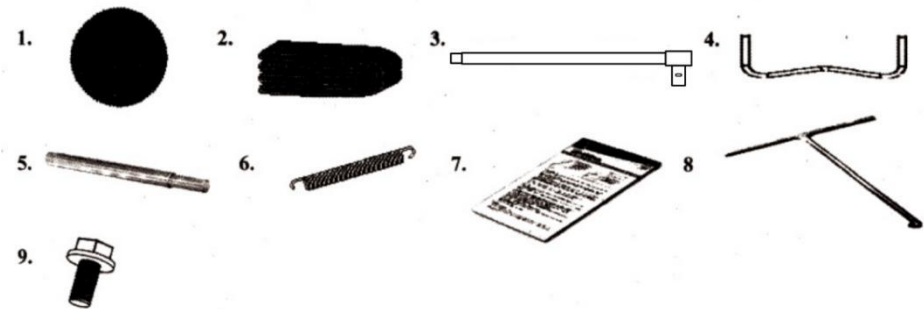

Frame layout

Please use the parts list table on other page to identify and layout all the parts as pictures, select which size trampoline you have purchased first, then refer to the following pictures.

All the "Top rail with leg sockets", are universal parts and can only go together in one way.

To connect the parts, simply slide the thinner end of the tubing into the adjacent section with the larger opening.

These joints are called "connector points".

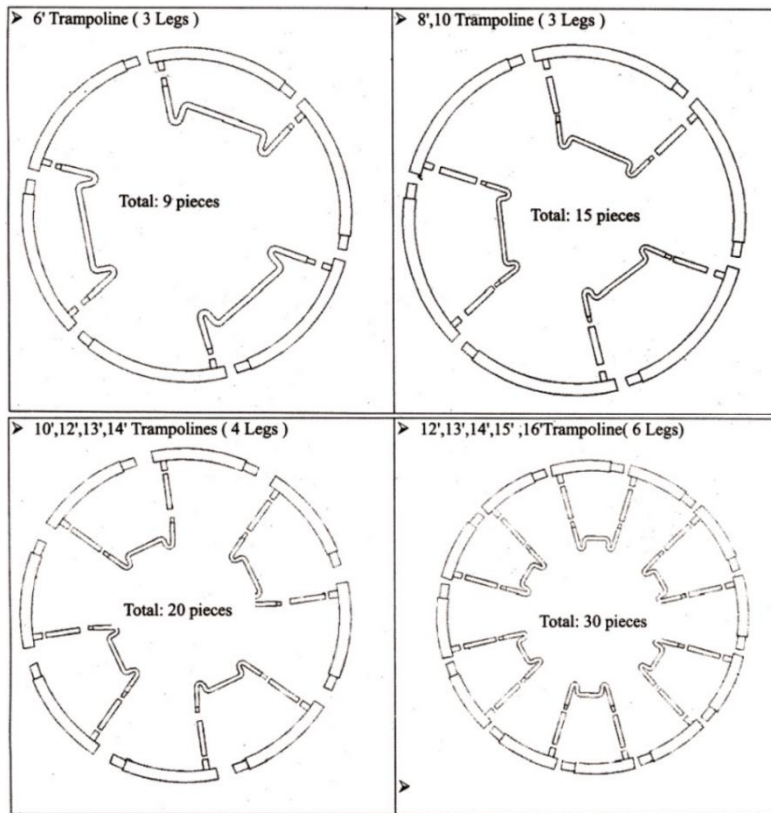

STEP 1 - Support Assembly

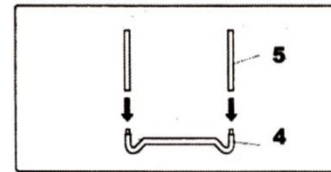

A. Slide all Vertical Leg Extensions (5) into the Leg Base(4) as shown

STEP 2 - Top Rail Assembly

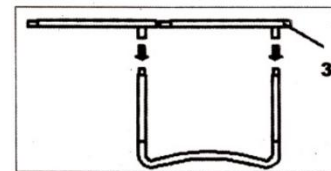

Two people will be necessary at this point to assemble the trampoline. One person lifts the Support Assembly from step 1 to a standing (vertical) position and inserts one of the sockets of the Top Rail with Sockets (3) into the Vertical Leg Extension portion of the Support Assembly. The other person holds the other end and inserts that portion into the other Support Assembly as shown. You should now have 2 Support Assemblies held together by 2 Top Rail with sockets.

After STEP 2 all of tube will be like Fig.5.

Then two people set up the tube the same to Fig 6.

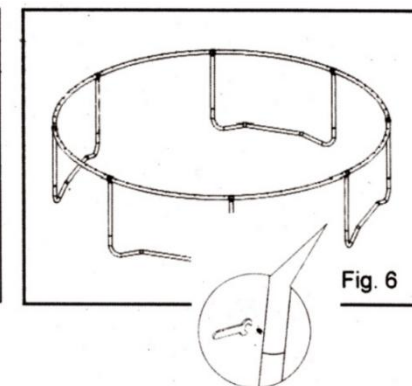
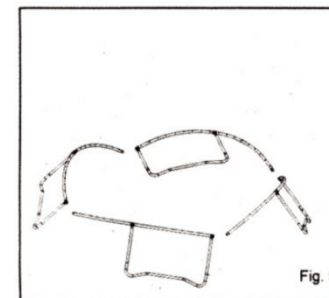

⚠WARNING :

- Trampolines over 20 in. (51 cm) tall are not recommended for children under 6 years of age.
- This enclosure is to be used only in connection with certain trampolines. Read and follow all warnings and instructions.
- It is strongly recommended that the customer purchase, install and maintain an enclosure that complies with Safety Specification F2225.
- This enclosure is to be used only in connection with certain trampolines. Read and follow all warnings and instructions.
- A ladder shall not be included as a component part or included in the same packaging of a trampoline. When a ladder is offered for sale it shall be sold only as a separate accessory.
- Ladder lets young children climb onto trampoline.
- Trampolines not for children under 6 years.
- Do not use ladder if children under six might be nearby.
- Remove when trampoline is not in use.

STEP 4: - Trampoline Mat Assembly

⚠️ WRNING: Attaching springs, the connector points can become pinch points since the trampoline is tightening up. With this in mind please be careful attaching springs to the trampoline mat. Please be careful.

You will need at least one person to help with this portion of assembly.

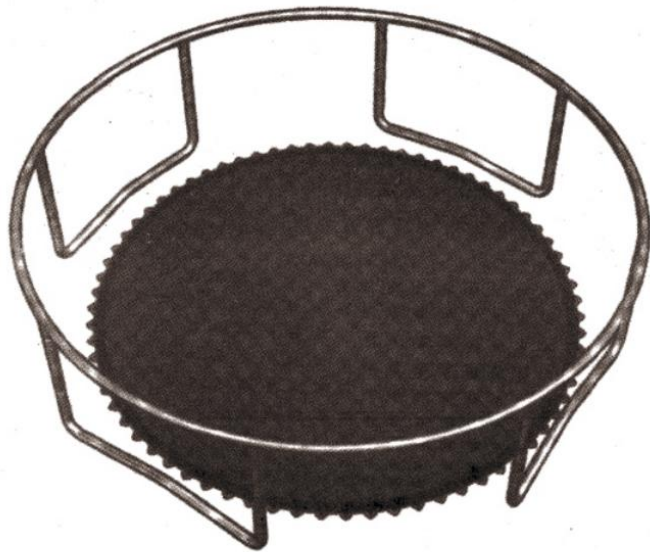

Layout the “**Trampoline Mat**” inside the frame on the floor as picture above.

STEP5: ATTACHING THE SPRINGS TO TRAMPOLINE MAT

The springs need to be placed in position as shown in the diagram to the right, in order to pull the “Trampoline Mat” in all four directions .

The image to the right specifies and details the spring positions to hold the “Trampoline Mat” in place. Please see the table for the positions of springs for the different sizes of Trampoline:

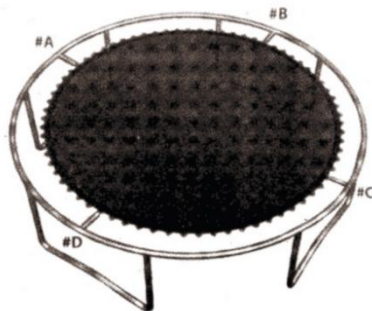

8FT trampoline	1	12	24	32
10FT trampoline	1	14	28	42
12FT trampoline	1	18	36	54
13FT trampoline	1	20	40	60
14FT trampoline	1	22	44	66
15FT trampoline	1	25	50	75
16FT trampoline	1	27	54	81

HOW TO USE THE “SPRING LOADING TOOL”

Firstly hang one side of spring on the triangle attached to The “Trampoline Mat”, and use the “spring tool” to hook the other side of spring (As shown in the top image.to the right).

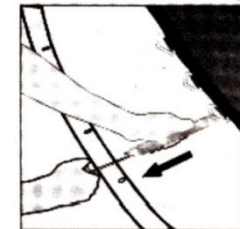

Pull the “Spring Tool” until the spring hook insert the hole on the “trampoline frame” and disengage the “Spring Tool” leaving the “Spring” in place. Repeat process for all springs .

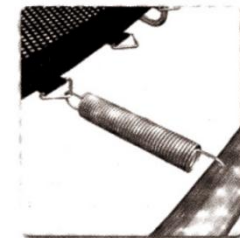

⚠️ WARNING: Please be careful where your hands and other parts of the body are placed as the connector points and spring attachments can create hand or body traps.

STEP 6-Safety placard Attachment

- A. Using the tie wrap, attach the Safety Instruction Placard (7) to the trampoline. The tie wrap should go around the Vertical Frame joint and the Top Rail to ensure that it doesn't slide off the trampoline.

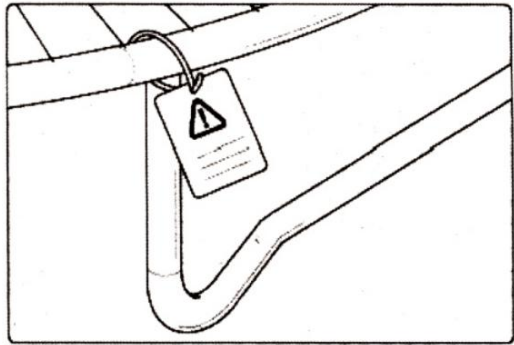

STEP 7-Frame Pad Assembly

- A. Lay the Frame Pad (2) over the trampoline so that the springs and the steel frame is covered. Please ensure that the Frame Pad covers all metal parts.
B. Tie the strap located at the under side of the frame pad to the frame.
C. Select your Pad model.

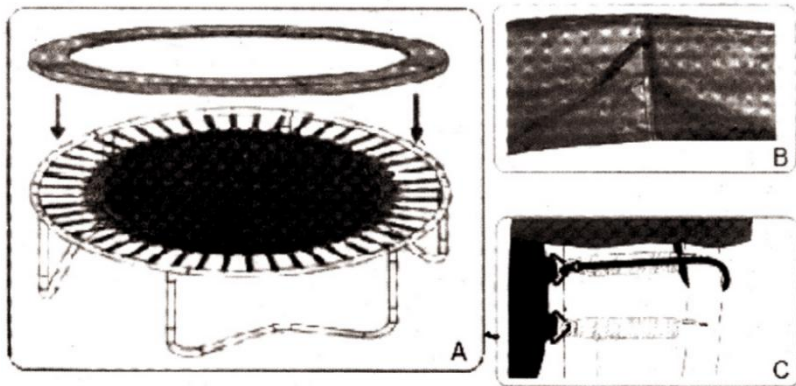

For safe use it is very important that the frame padding be securely attached to the frame and in the correct position prior to using the trampoline. Please refer to diagram

- Please make sure cover is positioned correctly to completely covers top rail, springs (or bands), and mat edge.

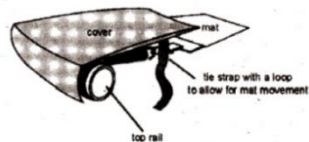

CARE AND MAINTENANCE

⚠WARNING

This trampoline was designed and manufactured with quality materials and craftsmanship. If proper care and maintenance is provided, it will provide all jumpers with years of exercise, fun, and enjoyment as well as reduce the risk of injury. Please follow the guidelines listed below:

This trampoline is designed to withhold a certain amount of weight and use. Please make sure that only one person at any one time uses the trampoline. Also, the person should weigh less than 300 pounds. Jumpers should either wear socks, gymnastics shoes, or be barefoot when using the trampoline. Please be aware that street shoes or tennis shoes should NOT be worn while using the trampoline. In order to prevent the trampoline mat from getting cut or damaged please do not allow any pets onto the mat. Also, jumpers should remove all sharp objects from their person prior to using the trampoline. Any type of sharp or pointed objects should be kept off the trampoline mat at all times.

Always inspect the trampoline before each use for worn, abused or missing parts. A number of conditions could arise that may increase your chances of getting injured. Please be aware of:

- Punctures, holes, or tears in the trampoline mat
- Sagging trampoline mat
- Loose stitching or any kind of deterioration of the mat
- Bent or broken frame parts, such as the legs
- Broken, missing, or damaged springs
- Damaged, missing, or insecurely attached frame pad
- Protrusions of any types (especially sharp types) on the frame, springs, or mat

IF YOU FIND ANY OF THE PREVIOUS CONDITIONS, OR ANYTHING ELSE THAT YOU FEEL COULD CAUSE HARM TO ANY USER, THE TRAMPOLINE SHOULD BE DISASSEMBLED OR SECURED FROM USE UNTIL THE CONDITION(S) HAS BEEN RESOLVED.

WINDY CONDITIONS

In severe wind situations, the trampoline can be blown about. If you expect windy weather conditions, the trampoline should be moved to a sheltered area or disassembled. Another option is to tie the round, outside portion (top frame) of the trampoline to the ground using ropes and stakes. To ensure security, at least three (3) tie downs should be used. Do not just secure the legs of the trampoline to the ground because they can pull out the frame sockets.

MOVING THE TRAMPOLINE

If you need to move the trampoline, two people should be used. All connector points should be wrapped secured with weather resistant tape, such as duct tape. This will keep the frame intact during the move and prevent the connector points from dislocating and separating. When moving, lift the trampoline slightly off the ground and keep it horizontal to the ground. For any type of other move, you should disassemble the trampoline.