

Assembly Instructions

Caution : You must read this before you proceed

Reclining Chair

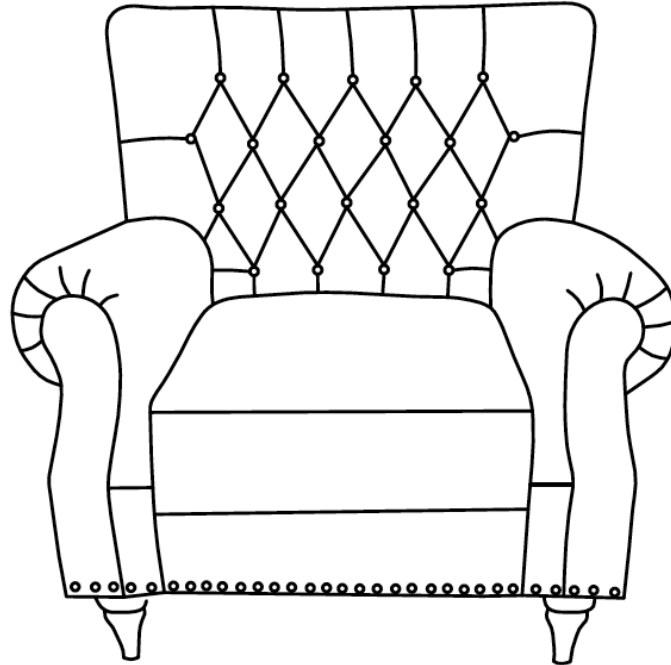



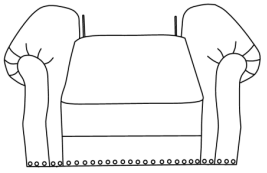
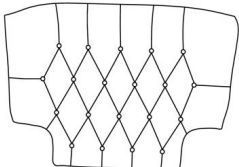

Parts List

Label	Picture	Description	QTY
A		Chair Base (with Preattached slide lock gadget)	1
B		Chair Backrest (with Preattached Metal Bracket)	1

C		Front Leg	2
D		Left Hind Leg	1
E		Right Hind Leg	1

Hardware

Label	Picture	Description	QTY
①		Bolt (M8*50MM)	3
②		Washer	3
③		Spring Washer	3
④		Allen Wrench	1
⑤		Gasket	5

Assembly Preparation

Before Beginning Assembly:

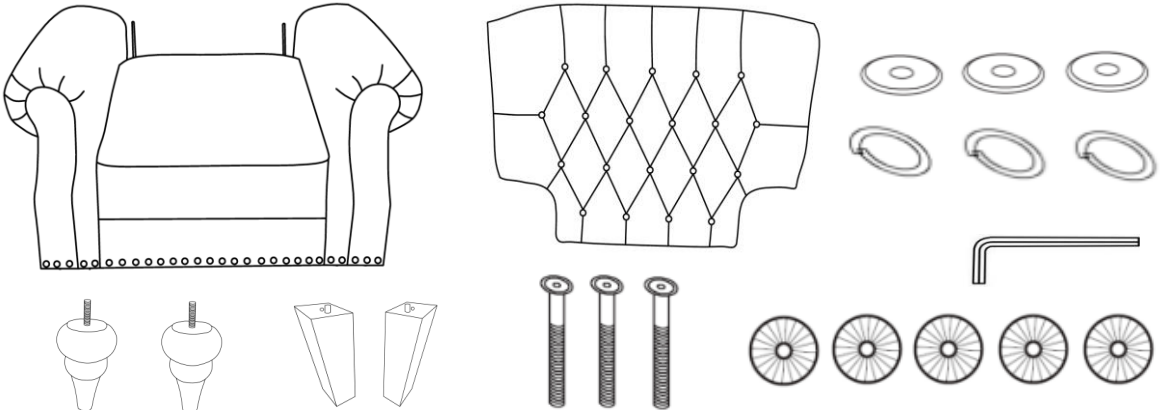

The diagram illustrates the components and hardware needed for assembly. It includes a side view of the chair frame with two front legs (C) and one hind leg (D or E). A diamond-patterned mesh backrest is shown. Hardware items are laid out: three bolts (1), three washers (2), three spring washers (3), one Allen wrench (4), and five gaskets (5). The hind legs (D and E) are also shown separately.



- Read instructions, cover to cover-



- Have 2 adults on hand for assembly-



- Do not assemble on flooring or carpet-



- Assemble on a clean non-marring surface (packing foam)-



- Save all packaging until finished-

Assembly Steps

Overview

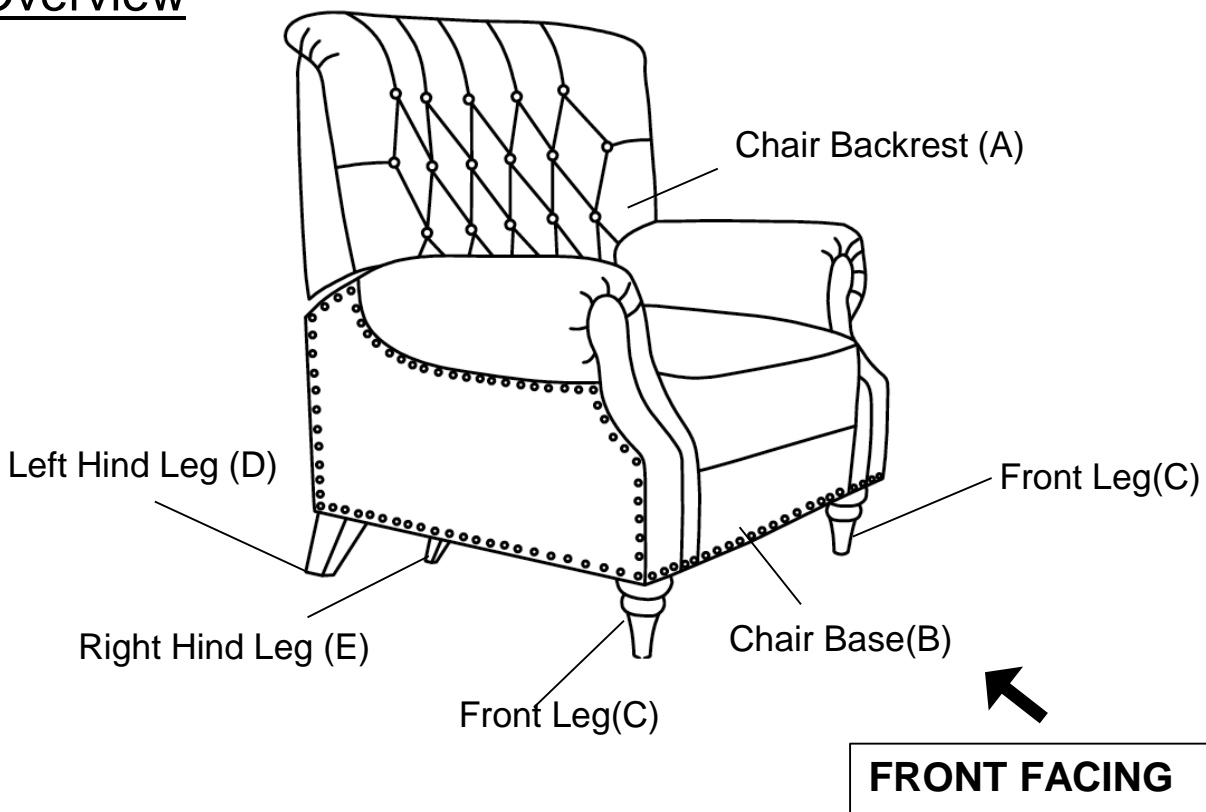

This Reclining Chair has multiple parts and may require up to 30 minutes to assemble. To give you an overview of the Reclining Chair parts, the above picture is to help you put the various parts into perspective. Please read through the instructions herebelow to familiarise yourself with the parts and steps before assembly.

Step

1

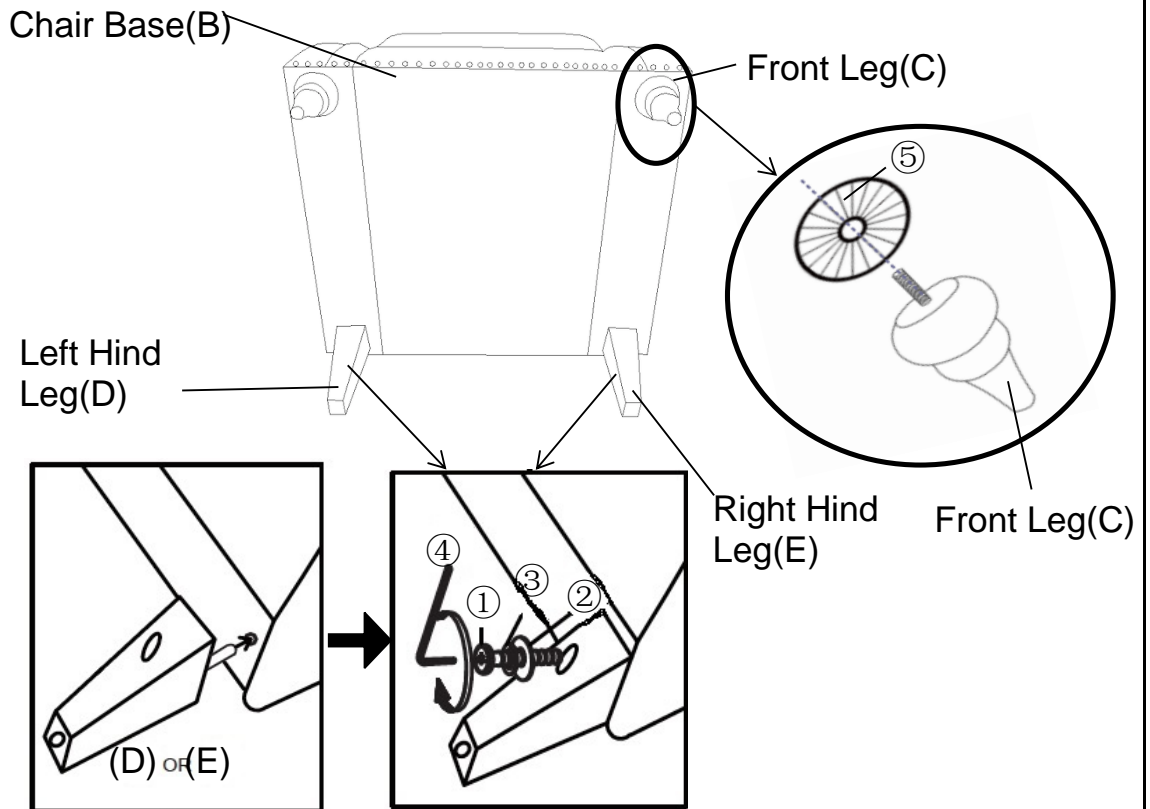

First, assemble the Front Legs (C). Place a Gasket (⑤) on the thread of each leg, then insert the Front Legs (C) and turn clockwise to two corresponding positions, affixing it firmly.

Then assemble the Right Hind Leg (E) and Left Hind Leg (D). Use the Allen Wrench (④) to affix the Bolts (①), Spring Washers (③) and Washers (②) to the corresponding positions. After affixing firmly, the Right Hind Leg (E) and Left Hind Leg (D) can be successfully assembled onto the Chair Base (A).

Step

2

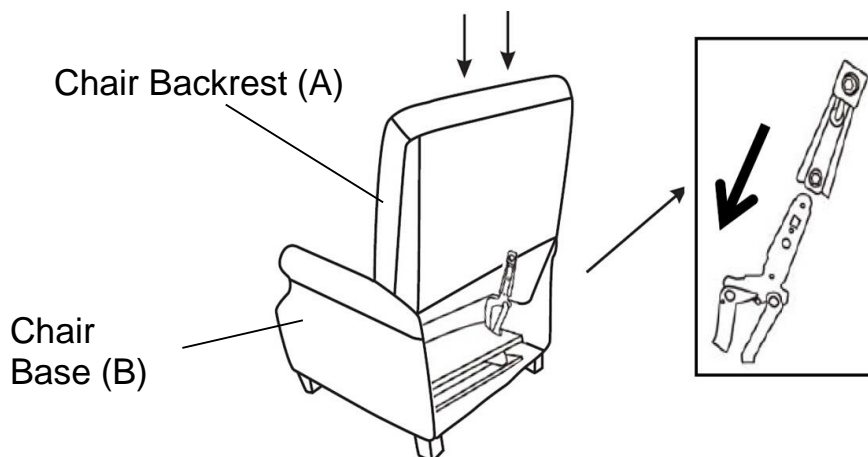

With assistance from your adult partner, hold up the fully assembled backrest, and stand behind the chair. Insert the preattached Metal Bracket on the sides of the Chair Backrest(A) into the preattached slide lock gadgets on the Chair Base(B) as shown above. Firmly but gently, push the Chair Backrest(A) downwards until the Chair Backrest(A) is fully slotted and locked into position.

Step
3

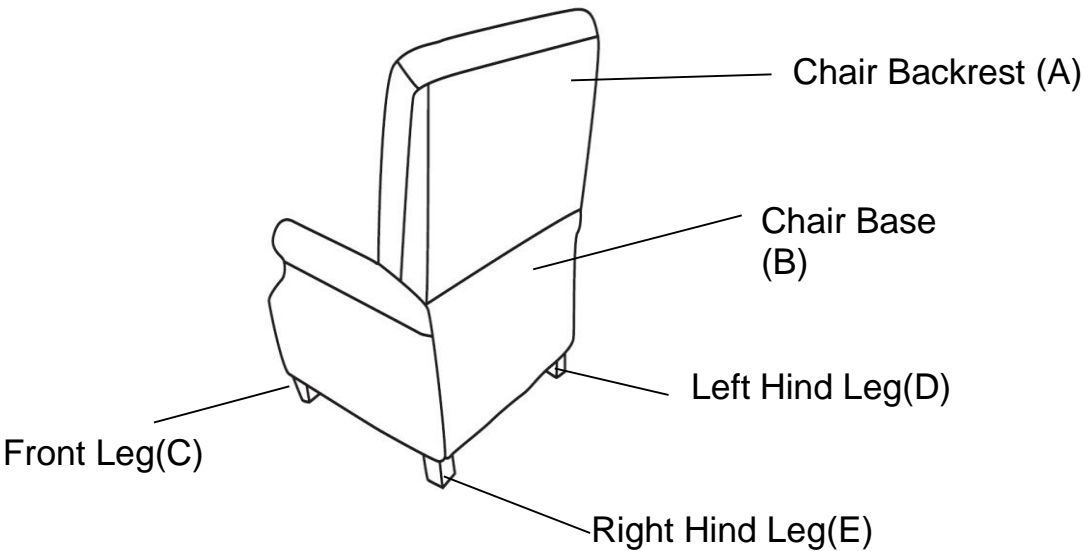

Smooth down the outer flap, on the back, on the Chair Backrest(A). Run your hands down both sides of the flap, from top to bottom, allowing the velcro tape to adhere to the flap under the seat of the chair. Your Recliner is ready for use.

Step
4

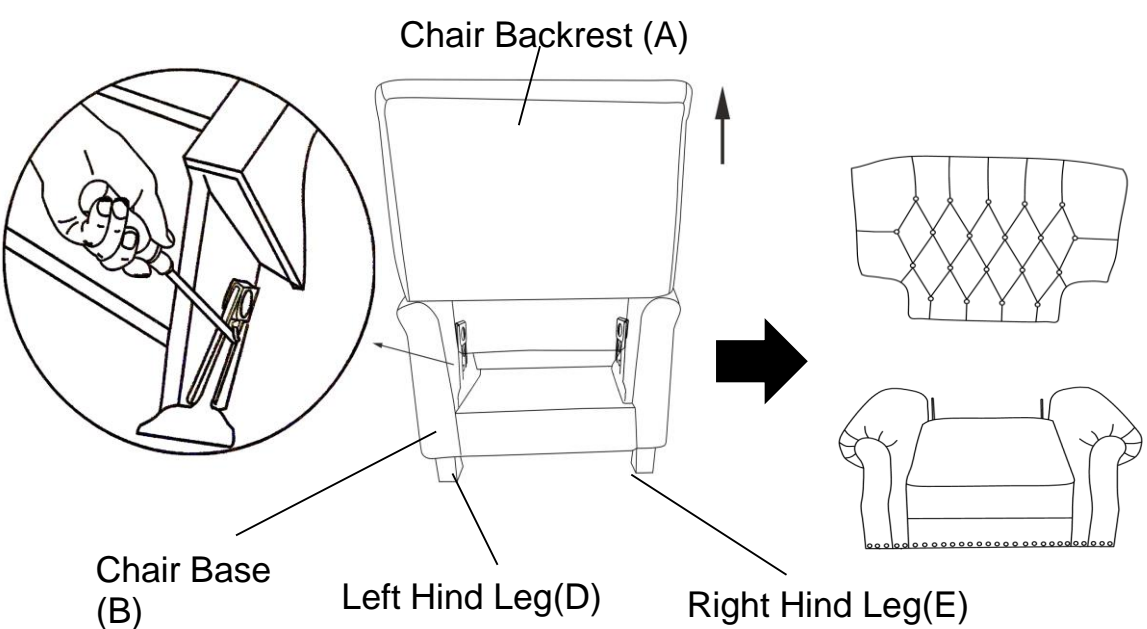

Disassembly Note: Open the flap on the Chair Backrest(A), use a screwdriver (Don't use fingers) pressing outward on the metal ear on the preattached Metal Bracket on one side of the Chair Backrest(A), with assistance from your adult partner to keep the Chair base(B) in place, pull out the Chair Backrest(A) upward at the same time, repeat the same step for the other side. Then the Chair Backrest(A) can be taken out.

User Instructions

Reclining Chair

Please read the Instruction Manual below carefully before use.

Children must be supervised when using this Recliner Chair.

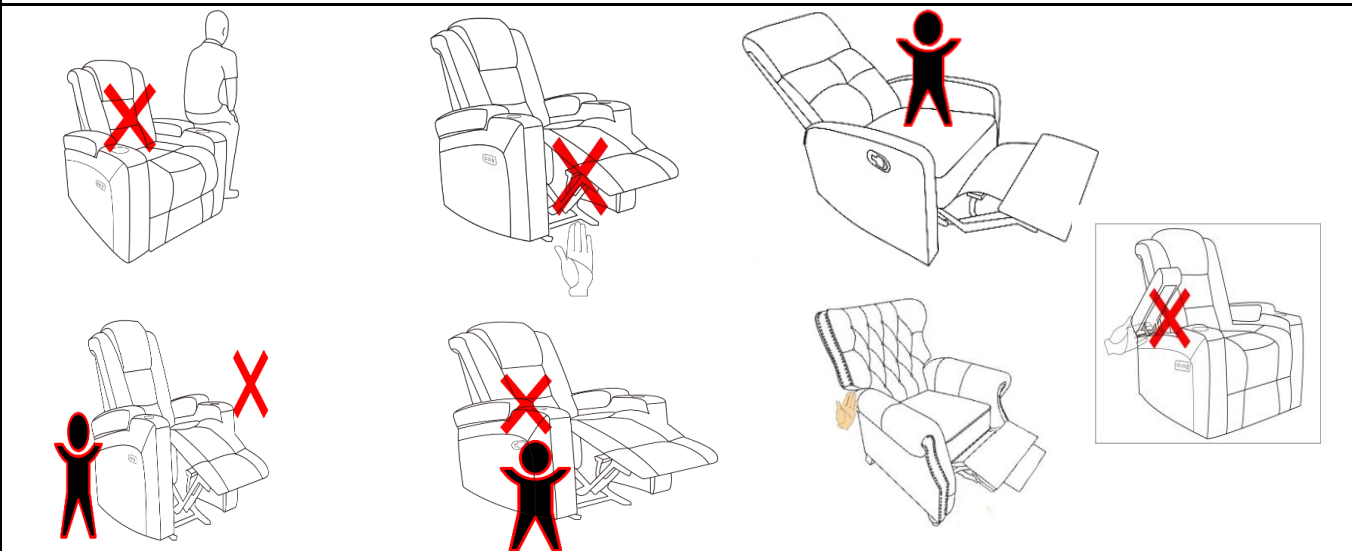

Do not let children stand in front of or behind the Reclining Chair when opening or closing the footrest.

Do not put your hands inside the Footrest when opening or closing the footrest.

Do not sit on the arms of the chair.

Do not stand on the chair.

Do not put your hands between the back and the armrest.

Do not put your hands around the clips of the storage arm.

To recline backrest:

Sit into the seat.

The Chair Backrest will fall back and a footrest will open when you push the Chair Backrest with your back. So you must put your feet on the footrest well when you push the Chair Backrest back. Open the trigger on the outside of the right armrest. Use your body weight and push backwards into the seat into a fully reclined position.

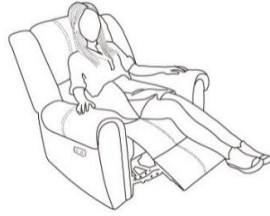

To get out of Chair:

Push the Footrest down with your Legs, then you can stand up.



Care & Maintenance



- Furniture may scratch floors. We recommend using furniture pads to protect your floors.



- Do not put hot items directly on furniture surface.



- Do not clean furniture with harsh cleansers or polish.



- Do not place furniture under direct sunlight.



- Do not place furniture near heating or cooling vents.



- Do not write on furniture without a padded barrier to protect the surface.



- Do not place furniture outside . For indoor use only.



- Not for commercial use. For residential use only.



- Stains may be removed with mild soap solution and damp cloth.



- Children should not climb or jump on the furniture.



- Dust and pick-up spills using a clean, non-colored, lint-free cloth.