

ASSEMBLY INSTRUCTION

MF311758

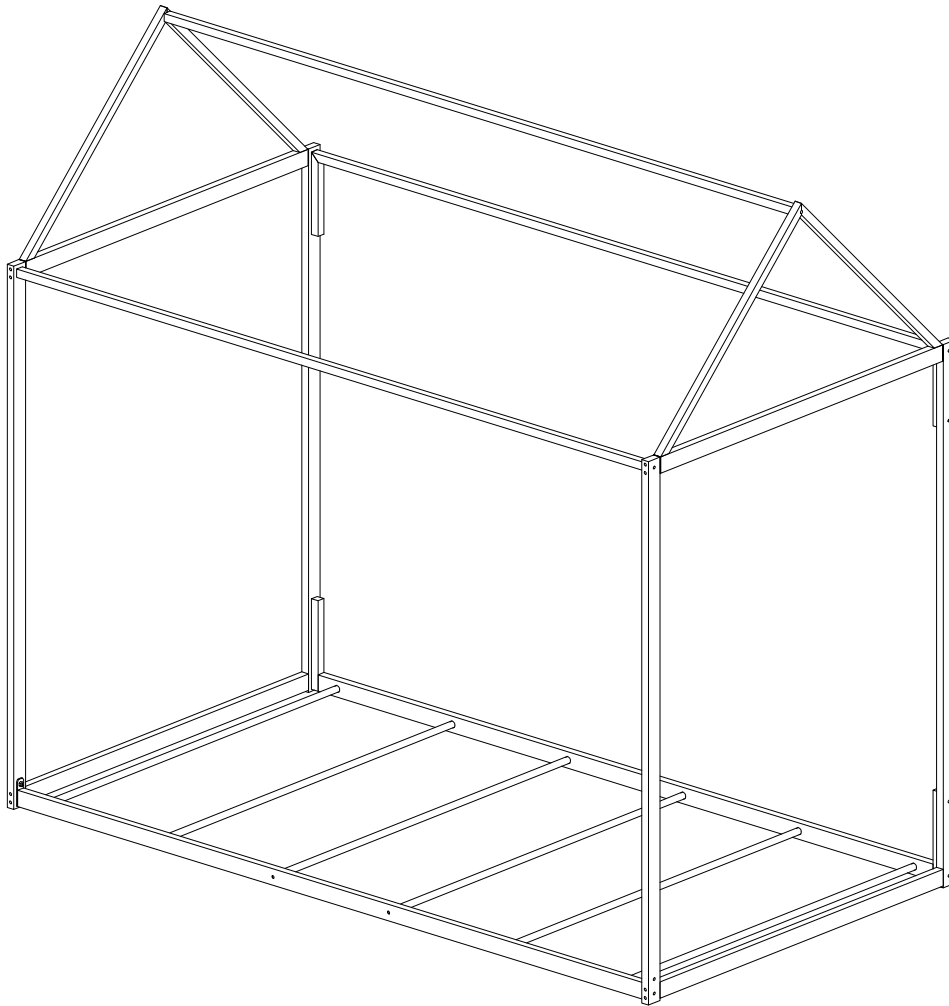

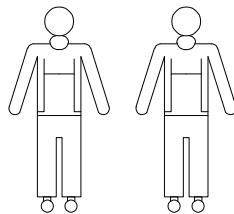

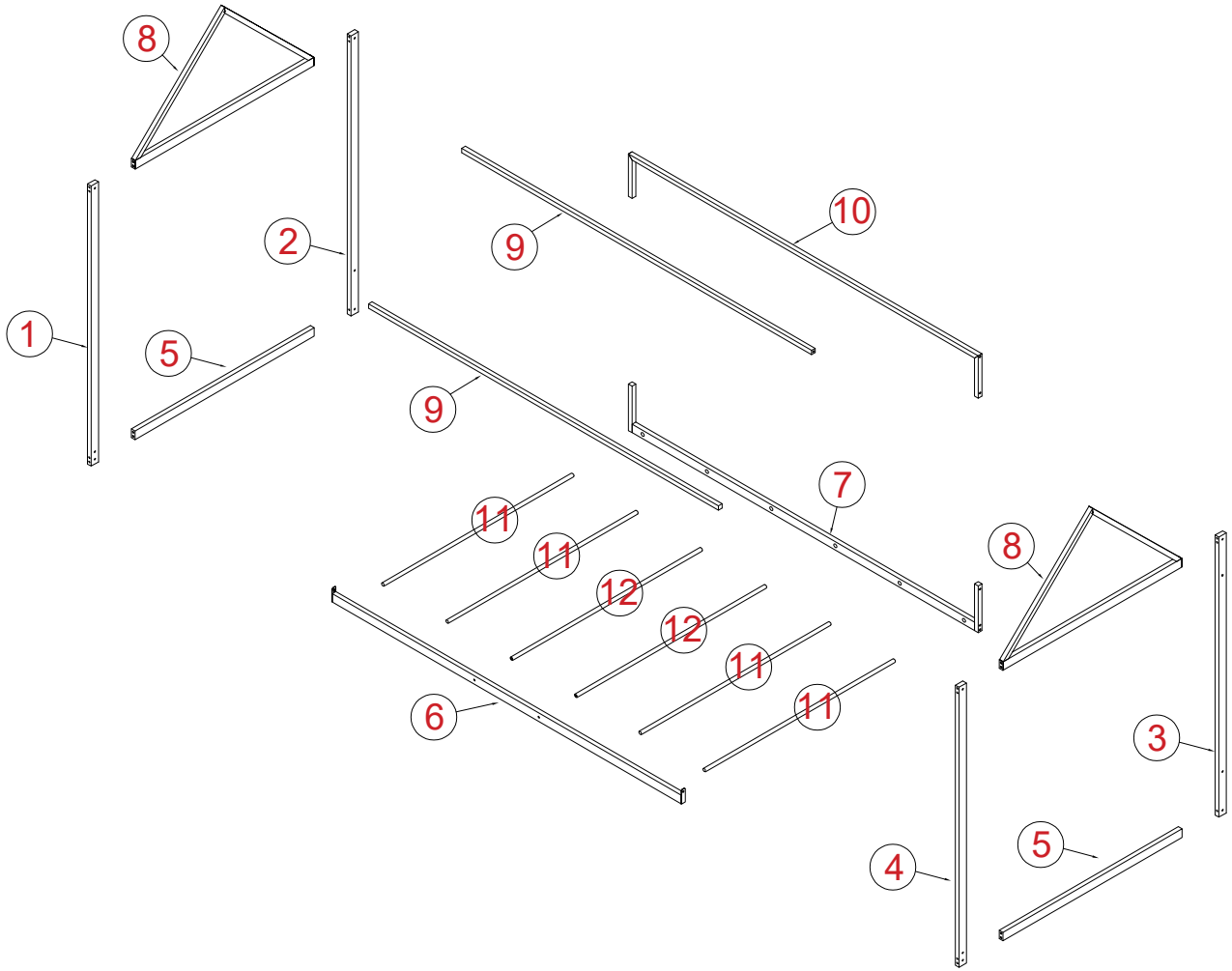

Minimum no. 2 of people
recommended to assemble
this product: Approx.
assembly time: 60 mins







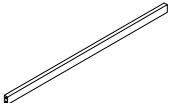
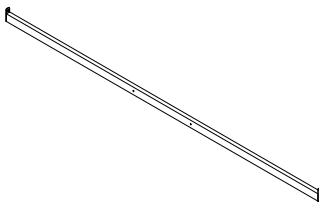
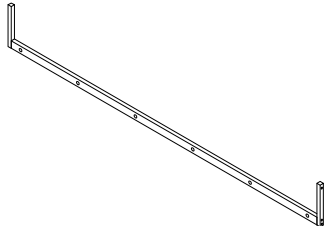
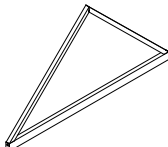
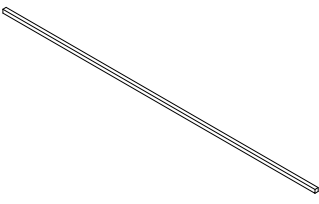
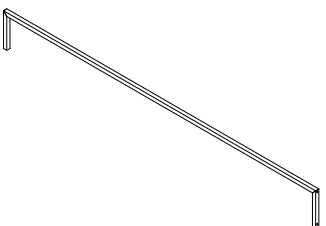
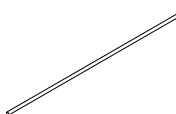
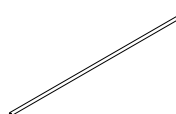

PART LIST MF311758

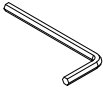

<p>1</p>  <p>1PC</p>	<p>2</p>  <p>1PC</p>	<p>3</p>  <p>1PC</p>
<p>4</p>  <p>1PC</p>	<p>5</p>  <p>2PCS</p>	<p>6</p>  <p>1PC</p>
<p>7</p>  <p>1PC</p>	<p>8</p>  <p>2PCS</p>	<p>9</p>  <p>2PCS</p>
<p>10</p>  <p>1PC</p>	<p>11</p>  <p>4PCS</p>	<p>12</p>  <p>2PCS</p>

HARDWARE LIST MF311758

<p>A</p>  <p>M$\frac{1}{4}$"X55 16 PCS</p>	<p>B</p>  <p>M$\frac{1}{4}$"X35 16 PCS</p>	<p>C</p>  <p>M$\frac{1}{4}$"X15 4 PCS</p>	<p>D</p>  <p>#20x40x13 4 PCS</p>	<p>E</p>  <p>#20x20x13 4 PCS</p>
<p>F</p>  <p>M4X23X57 1PC</p>				

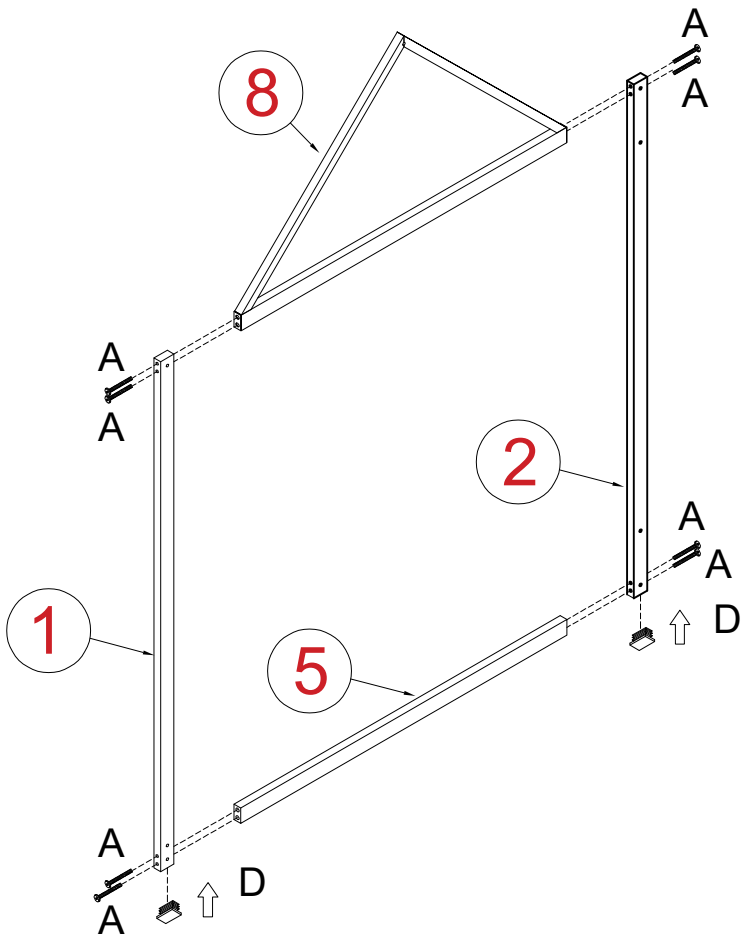
STEP 1



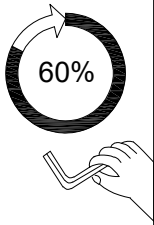

A	D
 $M\frac{1}{4} \times 55$	 #20x40x13
8 PCS	2 PCS

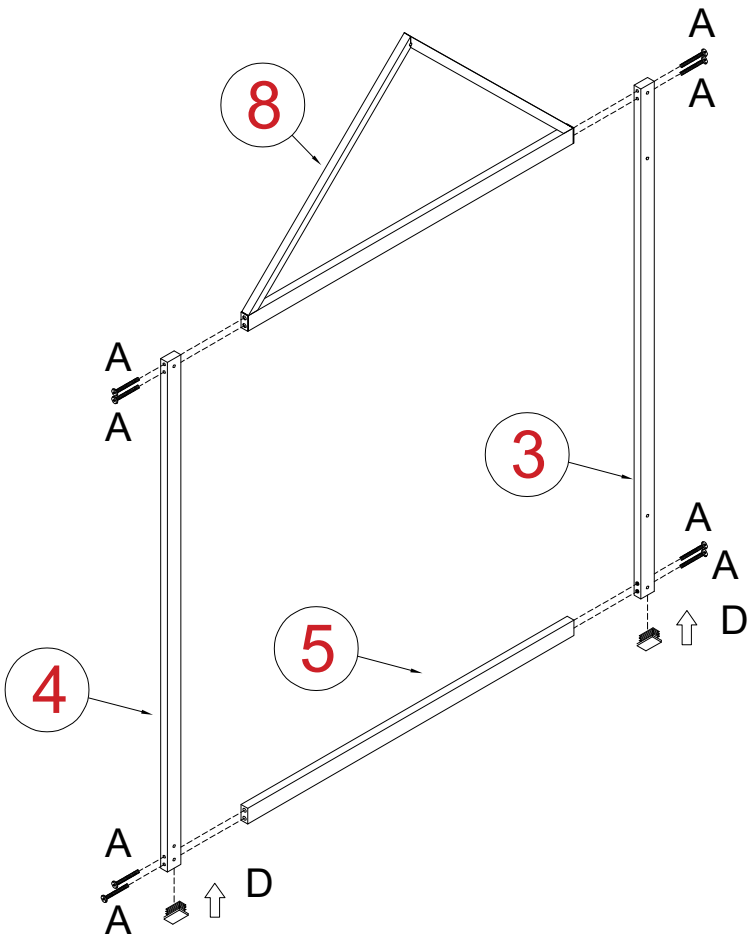

STEP 2



A	D
 $M\frac{1}{4} \times 55$	 #20x40x13
8 PCS	2 PCS

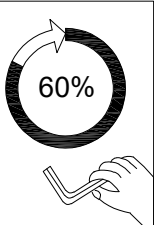

STEP 3

E

#20x20x13

4 PCS

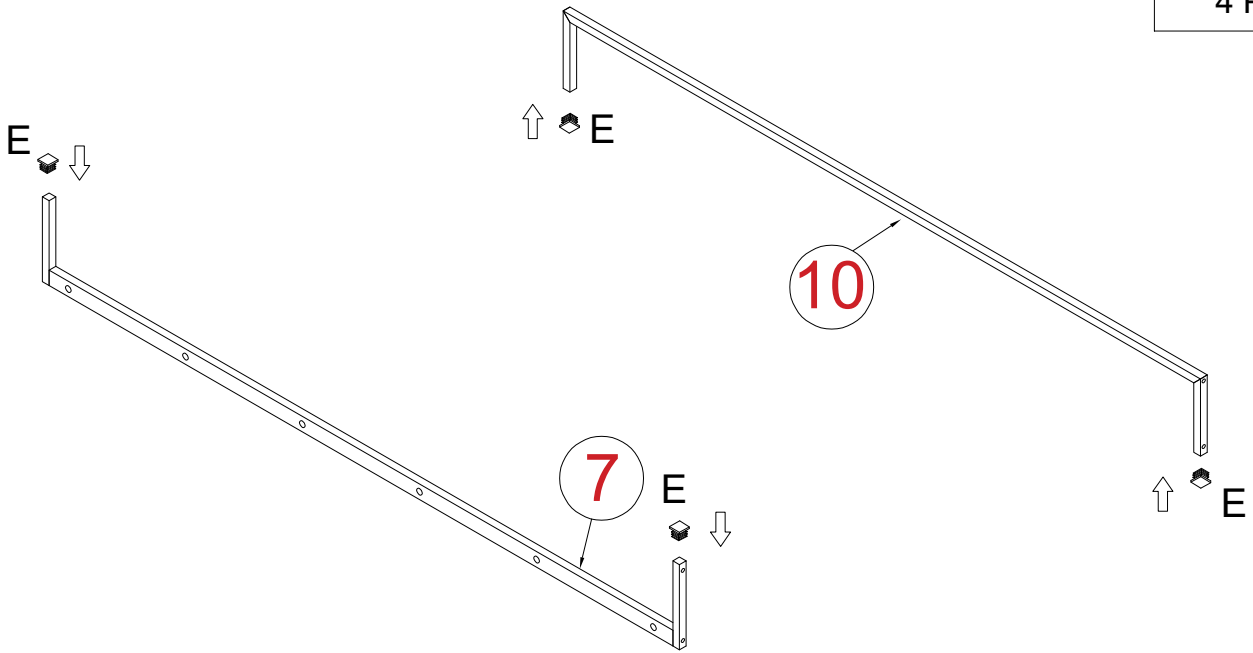

STEP 4

C

M $\frac{1}{4}$ "x15

4 PCS

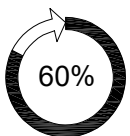
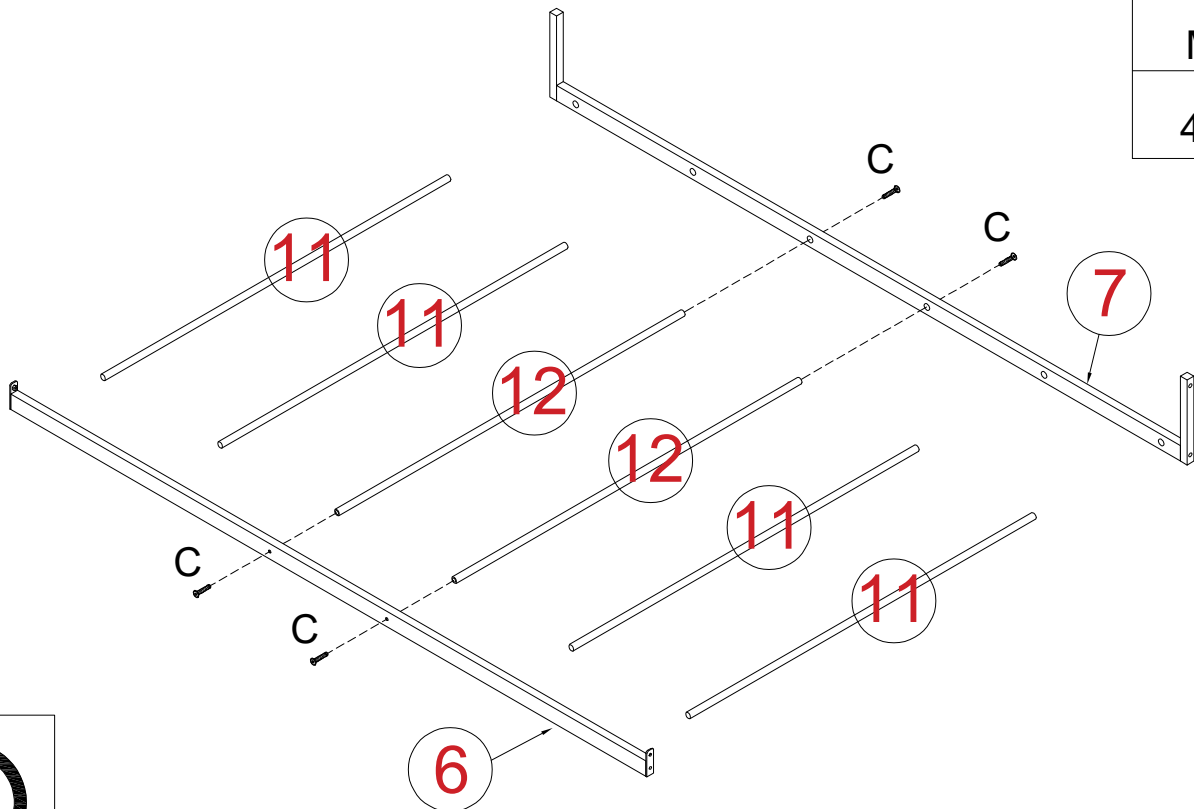

STEP 5

B

M $\frac{1}{4}$ x35

16 PCS

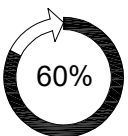
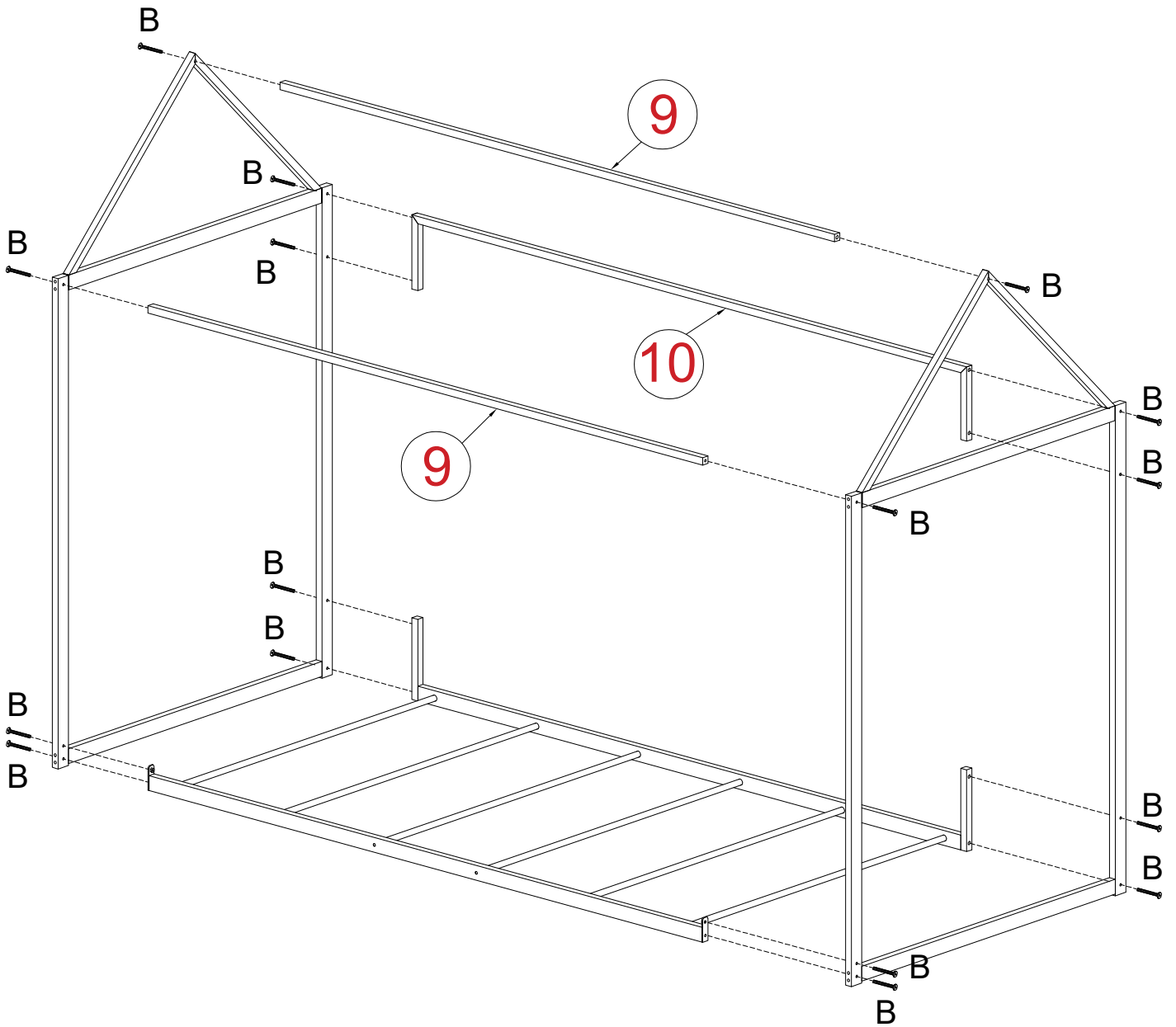

STEP 6

