

ASSEMBLY INSTRUCTIONS

ITEM: WF291263

Important note:

1. Place all wooden parts on a clean and smooth surface such as a rug or carpet to avoid scratching the parts.
2. Kindly follow the assembly instructions step by step.
3. Do not tighten all screws and bolts until the table is fully assembled.
4. Unscrew the protective plastique supports from the metal insert of the table legs before assembly.

PARTS IDENTIFICATION

A Table Top

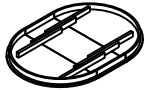

1pc

B Leg

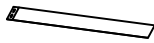

4pcs

C Connection panel

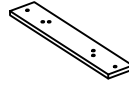

2pcs

D Long left Stretcher

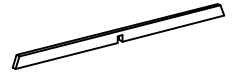

1pc

E Long right Stretcher

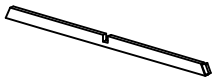

1pc

F Short left Stretcher



1pc

G Short right Stretcher



1pc

HARDWARE IDENTIFICATION

1 Bolt
1/4"X38mm
 12pcs

2 Spring Washer
1/4"X11mm
 12pcs

3 Flat Washer
1/4"X19mm
 12pcs

4 Allen Key
 1pc

5 Wood screw
#8X50mm
 8pcs

6 Wood screw
#8X38mm
 2pcs

STEP 1

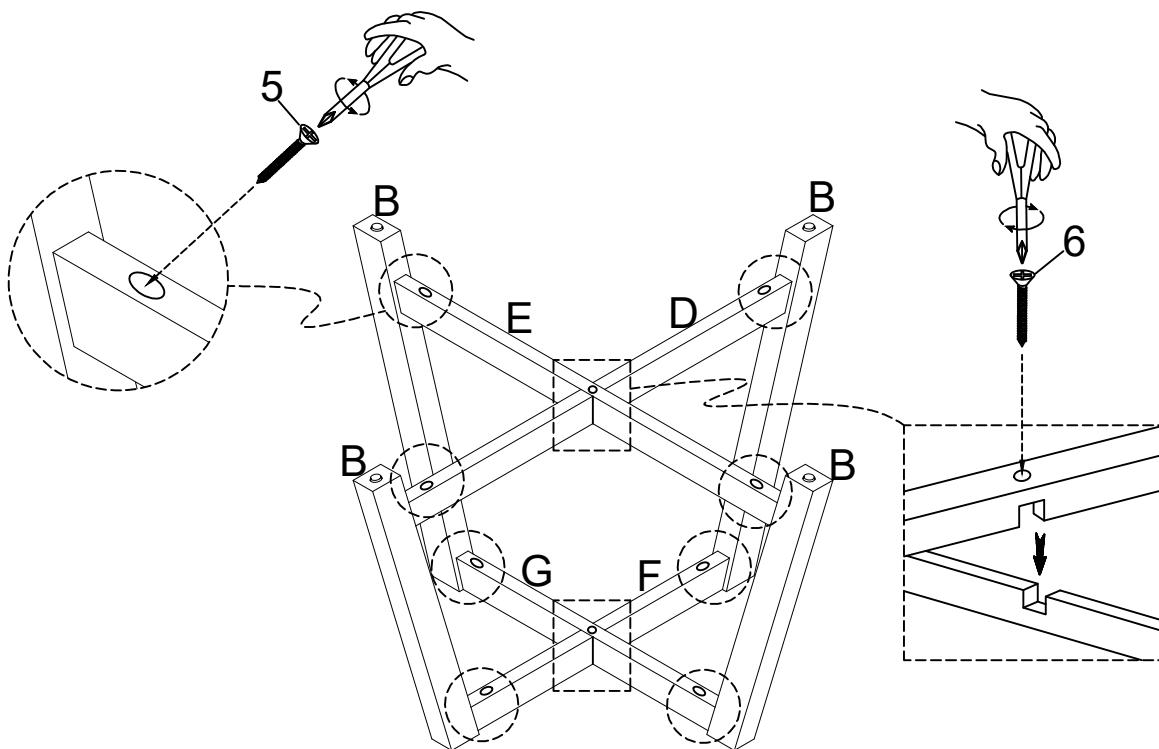

ASSEMBLY INSTRUCTIONS

ITEM: WF291263

STEP 2

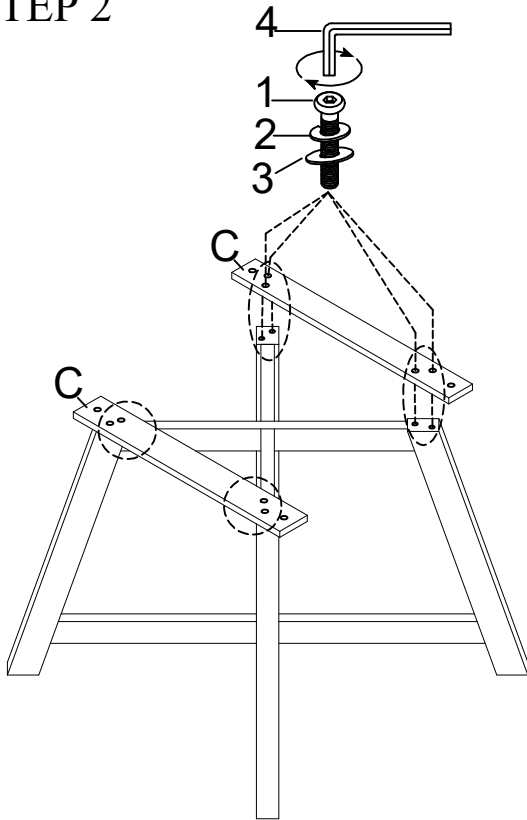

STEP 3

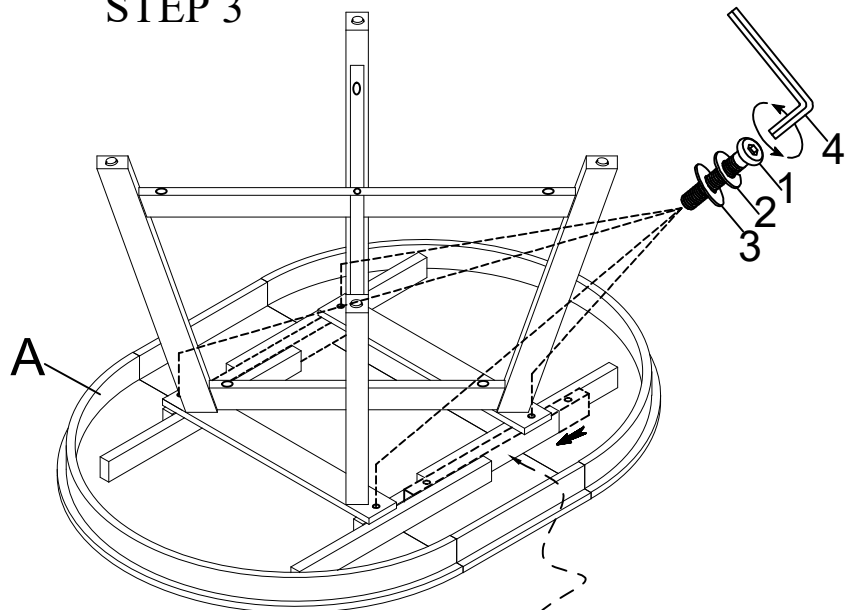

COMPLETE

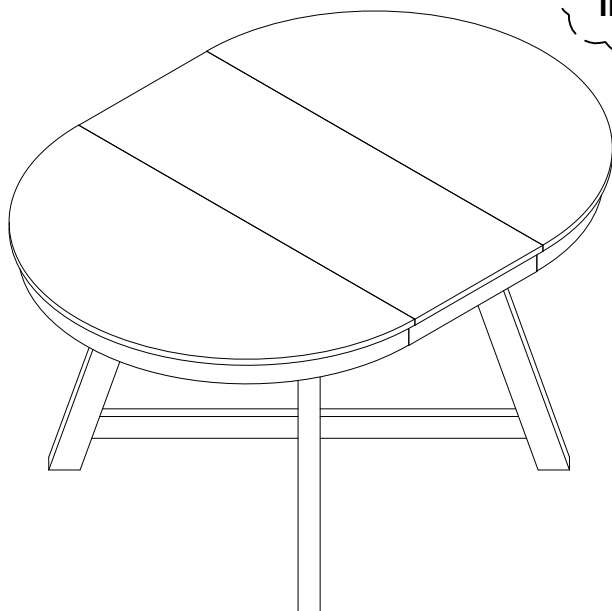

This part of the slide rail can be moved, if the holes are not aligned during the assembly process, please try to move the slide rail to the position shown in the figure and then assemble !