

ASSEMBLY INSTRUCTION

MF314055

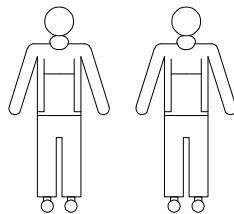

Minimum no. 2 of people
recommended to assemble
this product: Approx.
assembly time: 60 mins



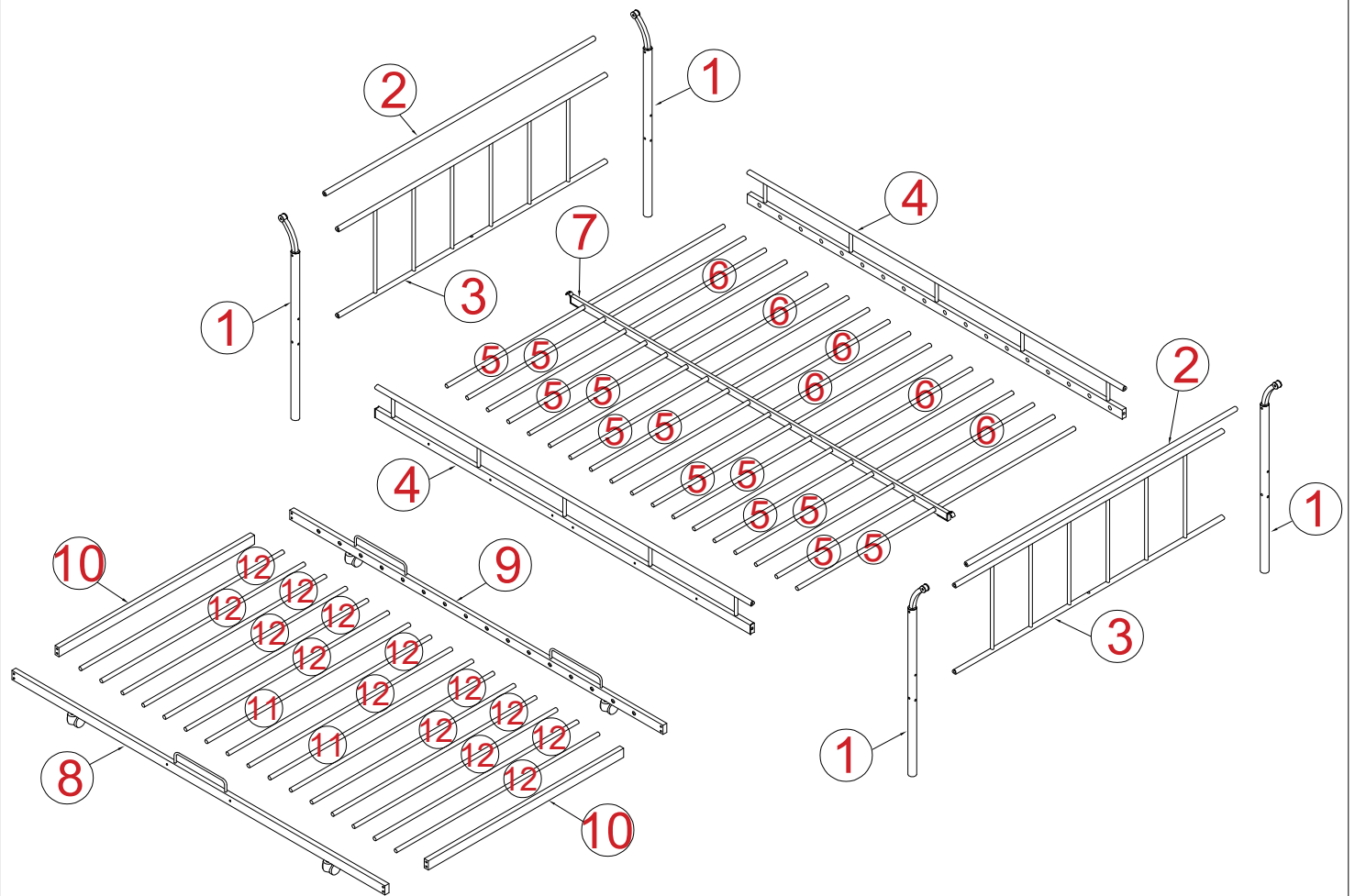



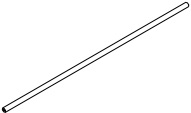
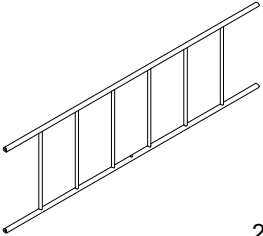
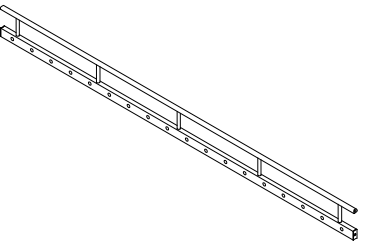
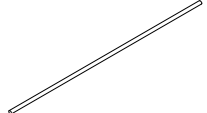
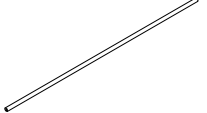
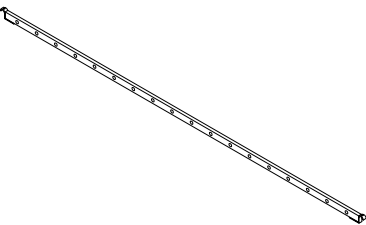
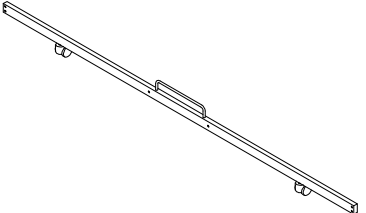
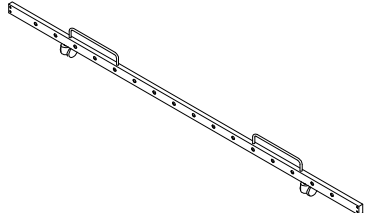
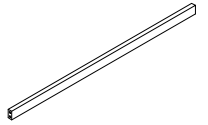
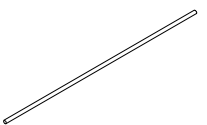
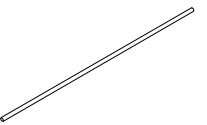

PART LIST MF314055

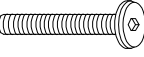
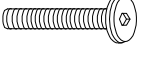
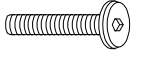
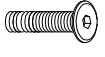

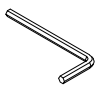
<p>1</p>  <p>4PCS</p>	<p>2</p>  <p>2PCS</p>	<p>3</p>  <p>2PCS</p>
<p>4</p>  <p>2PCS</p>	<p>5</p>  <p>12PCS</p>	<p>6</p>  <p>6PCS</p>
<p>7</p>  <p>1PC</p>	<p>8</p>  <p>1PC</p>	<p>9</p>  <p>1PC</p>
<p>10</p>  <p>2PCS</p>	<p>11</p>  <p>2PCS</p>	<p>12</p>  <p>14PCS</p>

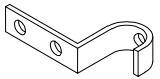
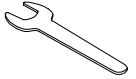
HARDWARE LIST MF314055

<p>A</p>  <p>16PCS M$\frac{1}{4}$"X50</p>	<p>B</p>  <p>4 PCS M$\frac{1}{4}$"X40</p>	<p>C</p>  <p>8 PCS M$\frac{1}{4}$"X35</p>	<p>D</p>  <p>22PCS M$\frac{1}{4}$"X15</p>
<p>E</p>  <p>4PCS Ø32x20</p>	<p>F</p>  <p>1PC M4X23X57</p>	<p>G</p>  <p>M$\frac{5}{16}$"xØ50x70H 2 PCS</p>	<p>H</p>  <p>M$\frac{5}{16}$"xØ50x70H 2 PCS</p>
<p>i</p>  <p>2PCS 7x70x68</p>	<p>J</p>  <p>1PC 13mm</p>		



STEP 1

2 SET

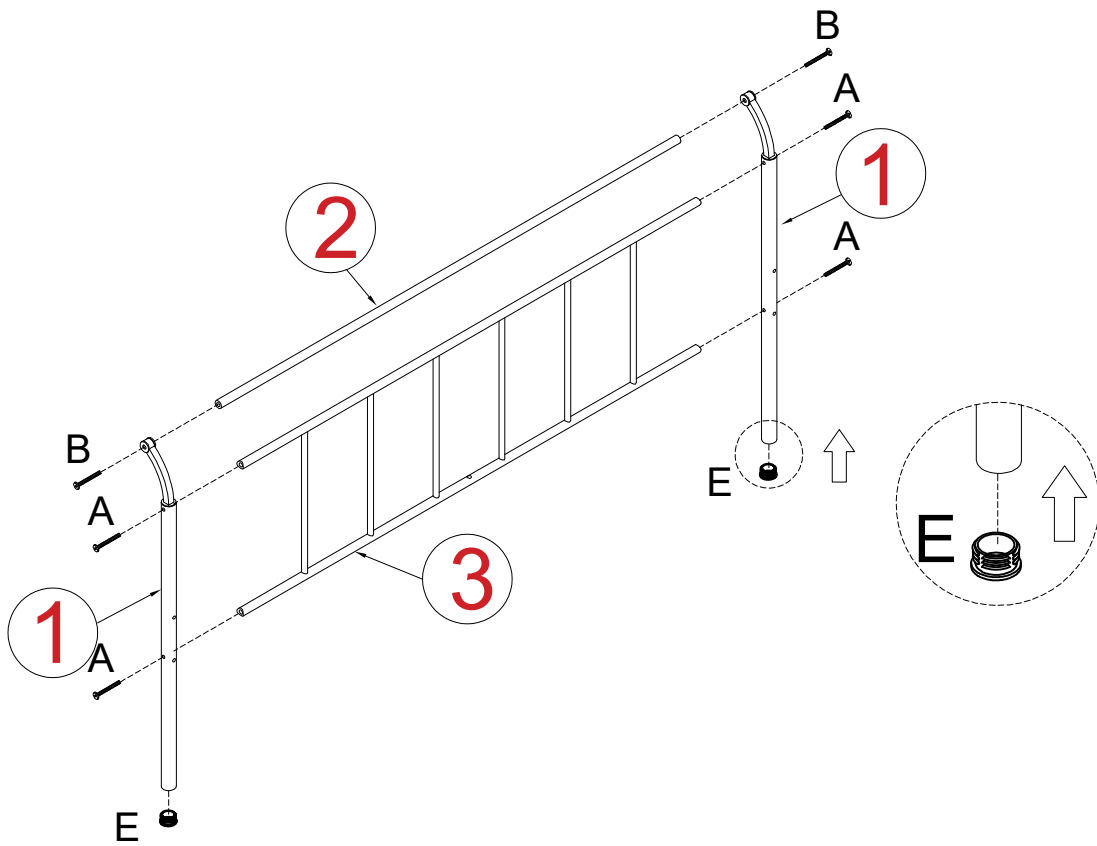
A	B	E
		
M $\frac{1}{4}$ "x50	M $\frac{1}{4}$ "x40	Ø32x20
8 PCS	4 PCS	4 PCS



STEP 2

D	i
	
M $\frac{1}{4}$ "x15	7x70x68
4 PCS	2PCS

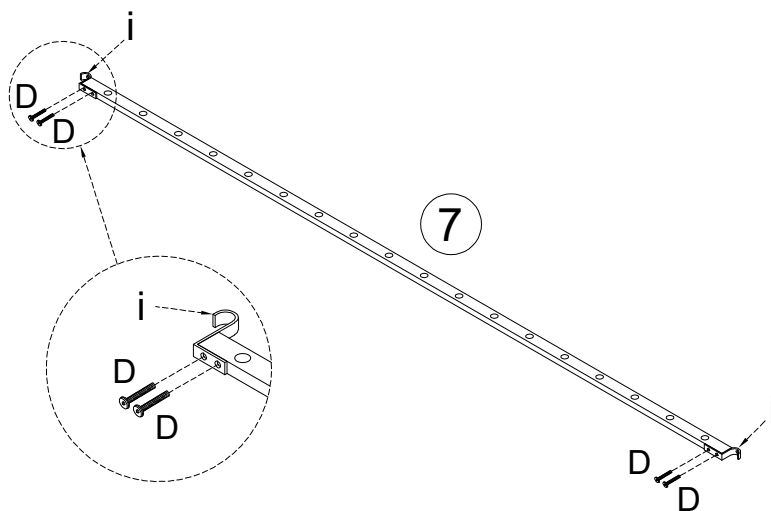

STEP 3

D

M $\frac{1}{4}$ x15

12 PCS

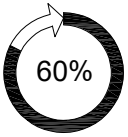
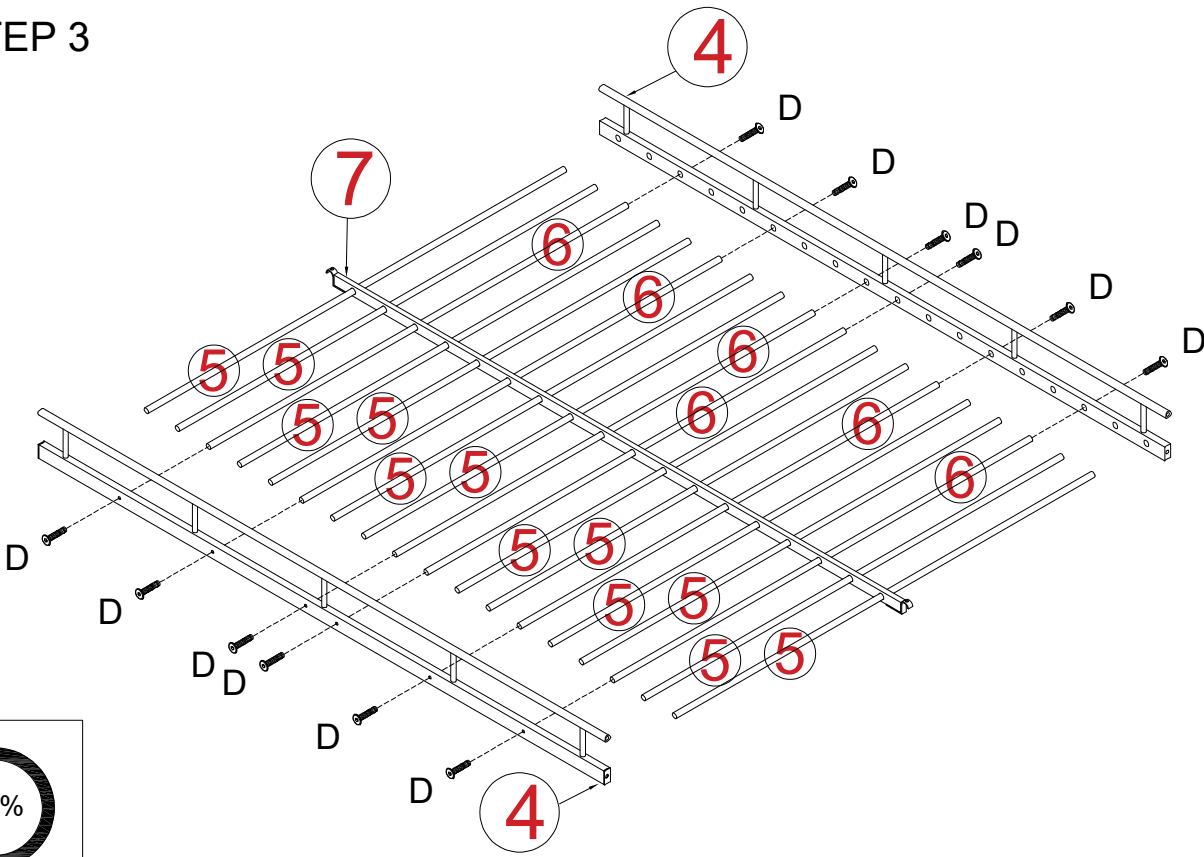

STEP 4

A

M $\frac{1}{4}$ x50

8 PCS

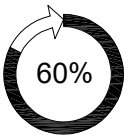
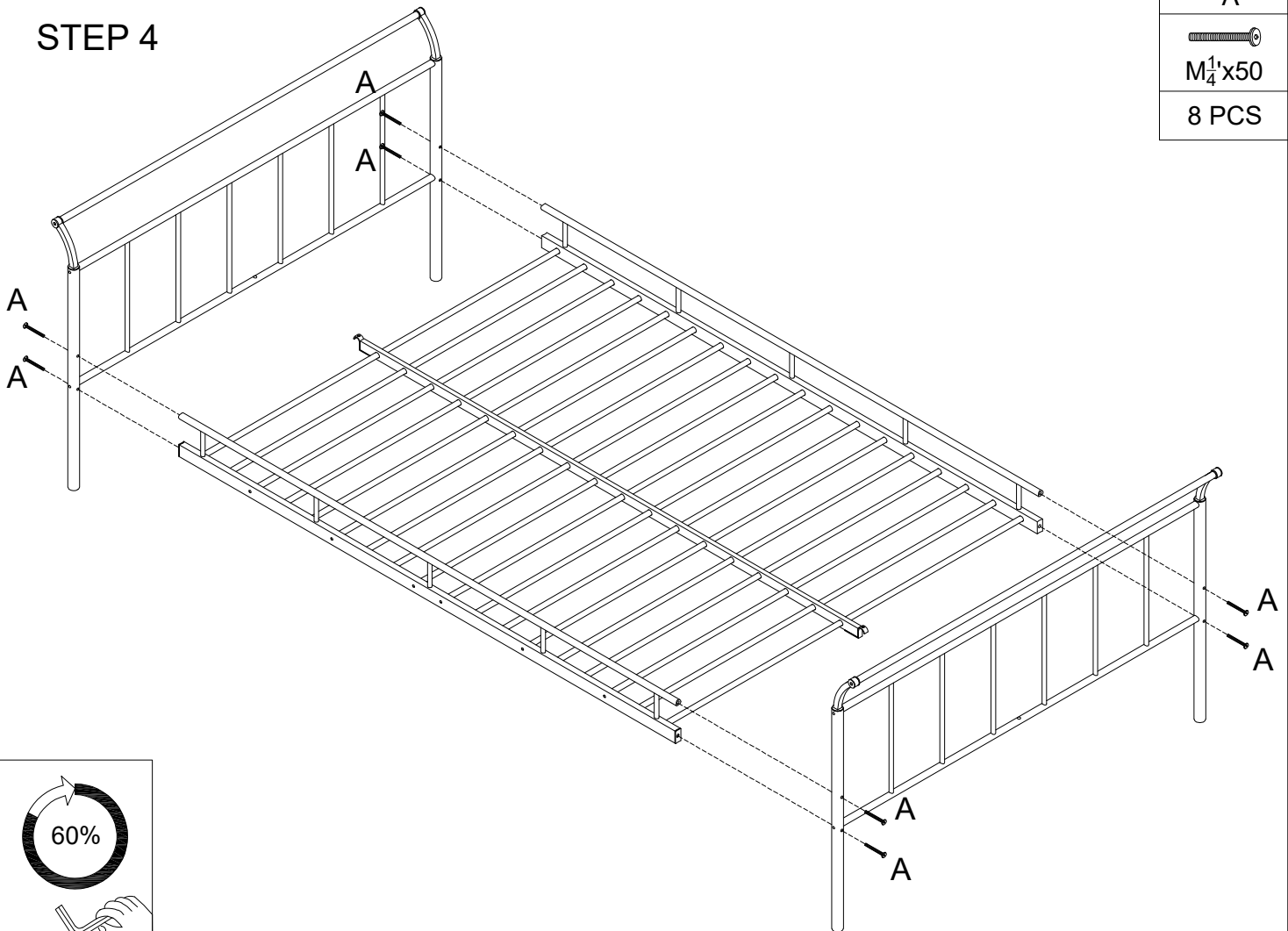

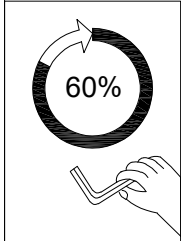
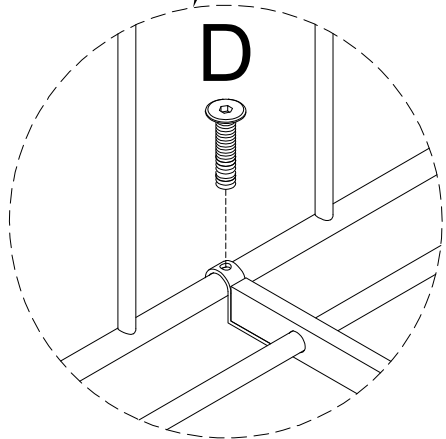
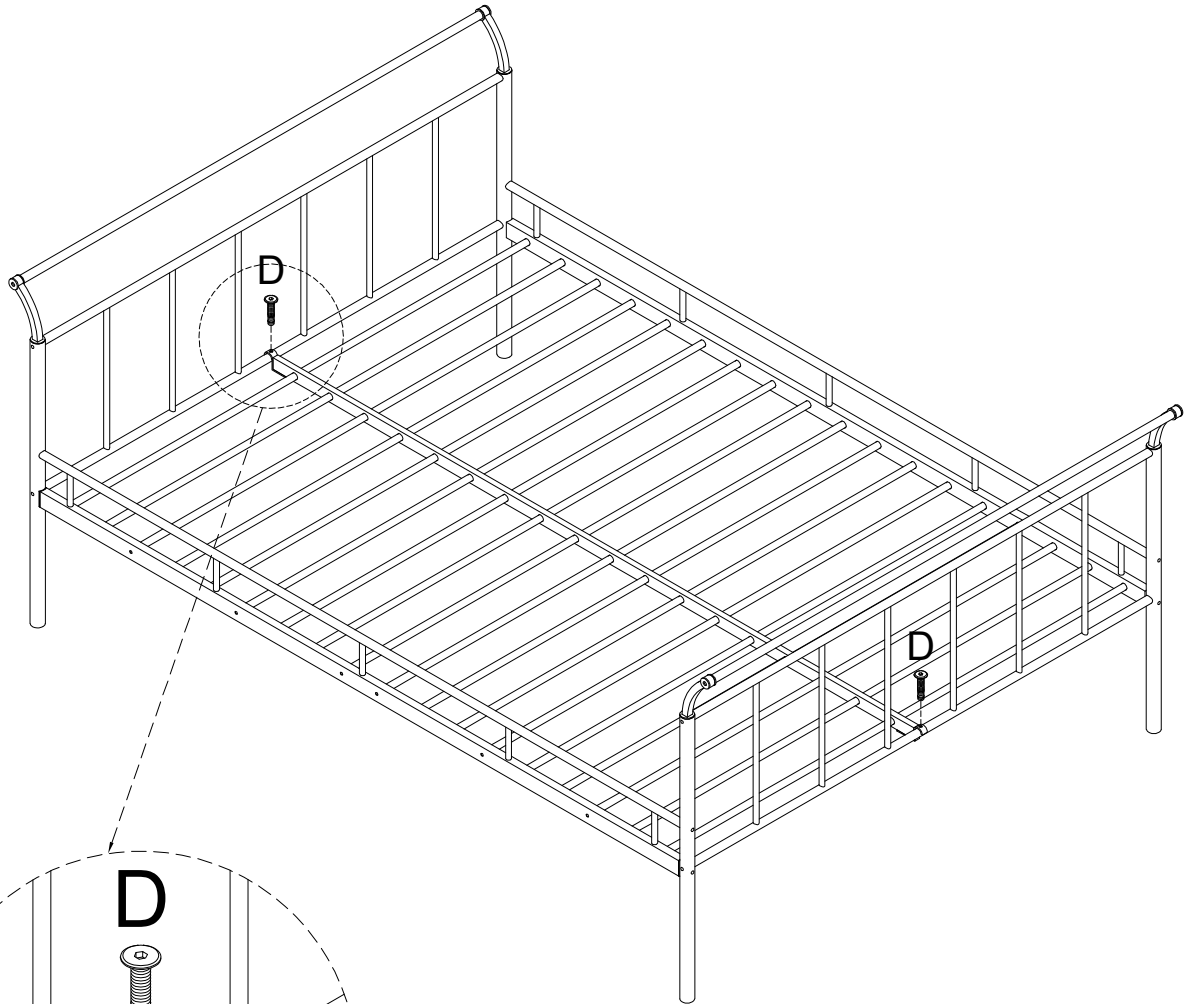

STEP 5

D
 M $\frac{1}{4}$ "x15
2 PCS



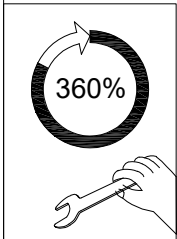
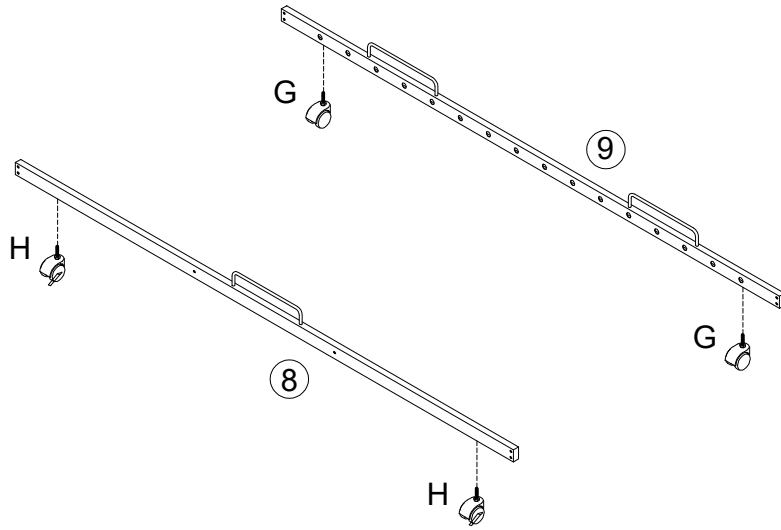

STEP 6

G	H
 M $\frac{5}{16}$ "xØ50x70H	 M $\frac{5}{16}$ "xØ50x70H
2 PCS	2 PCS



STEP 7

C	D
 M $\frac{1}{4}$ "x35	 M $\frac{1}{4}$ "x15
8 PCS	4 PCS

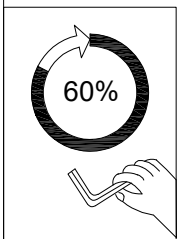
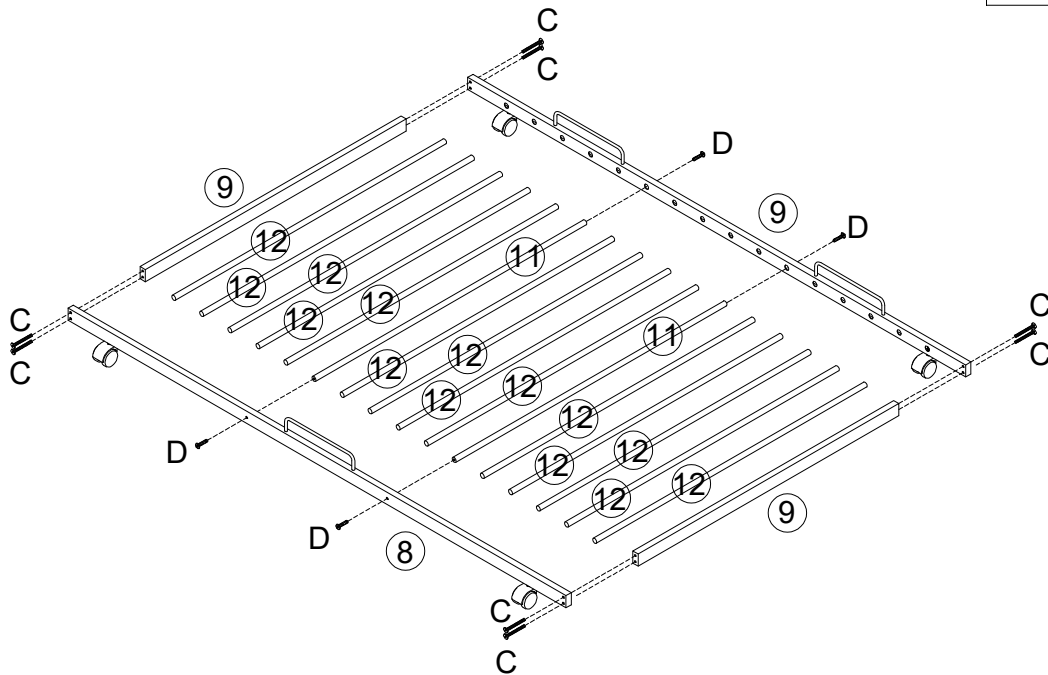

STEP 8

