

ASSEMBLY INSTRUCTION

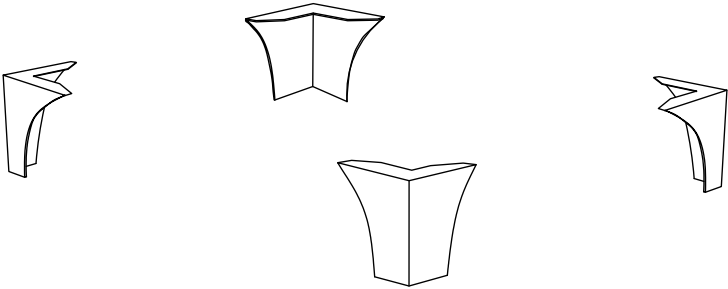

SKU CODE : WF307773

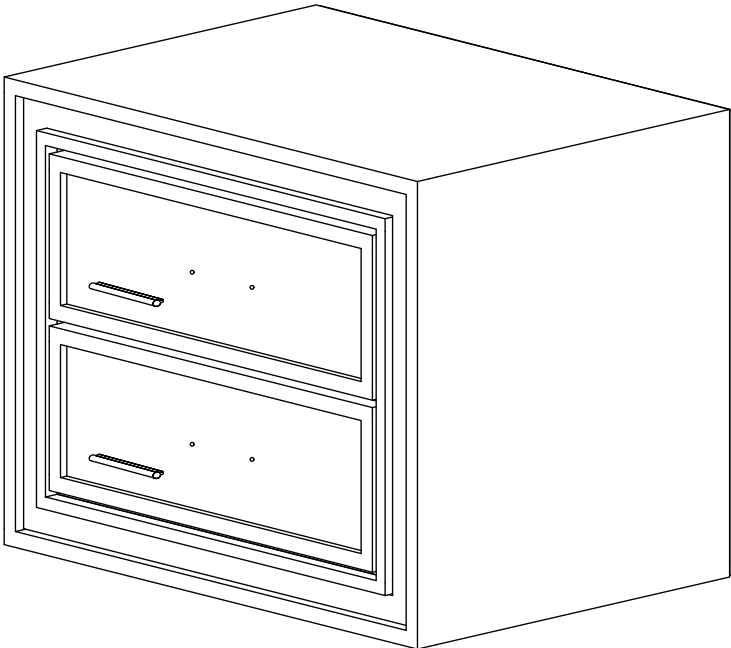

Detail View - NIGHT STAND

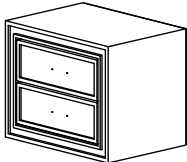
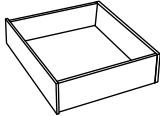
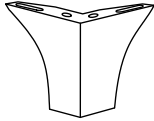
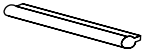

NO	PART LIST		QTY
A	Night Stand		1 pc
B	Drawer		2 pcs
C	Leg		4 pcs
D	Handle		2 pcs

NO	HARDWARE LIST		QTY
1	CSK M4 x 16MM		12 pcs
2	HANDLE SCREW M4		2 pcs
3	WASHER M4		2 pcs

Read this instruction carefully. Remove all wrapping material, staples and straps from the carton. See hardware and furniture part list for guidance. Be sure you have all wooden furniture parts on a clean and flat surface, such as carpet or rug, to prevent from being scratched.

CAUTION :

1. Do not Full Tighten the nut or screw until all ready to assemble.
2. Do not Over Tighten the nut or screw to avoid causing damages to the thread.
3. Keep all hardware part out reach of children.

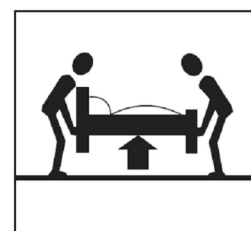
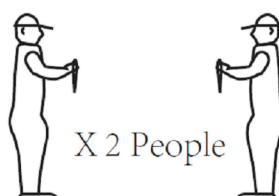
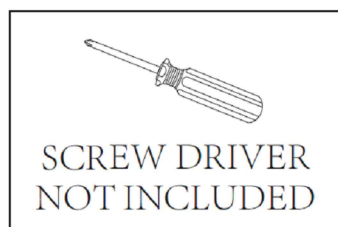

STEP 1

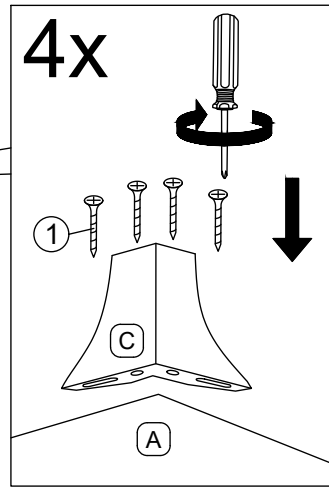
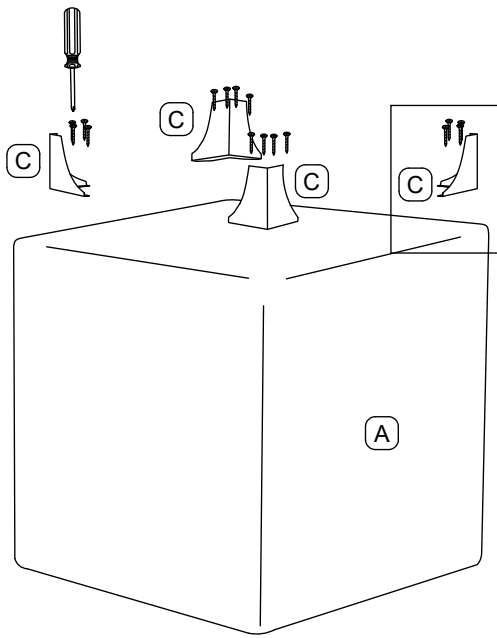



1

12 pcs

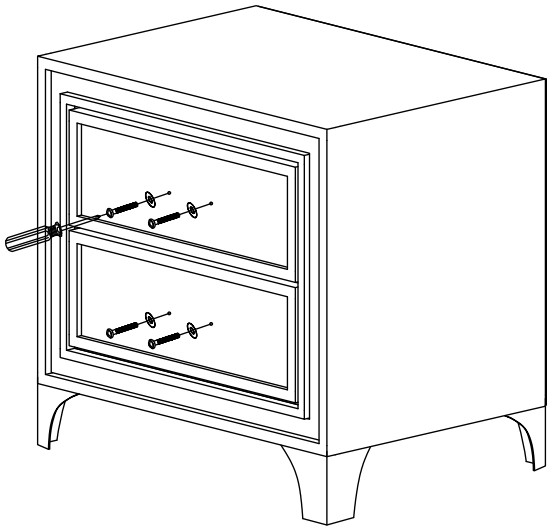
STEP 2

Remove hardware 2 & 3



STEP 3

2	3
	
4 pcs	4 pcs

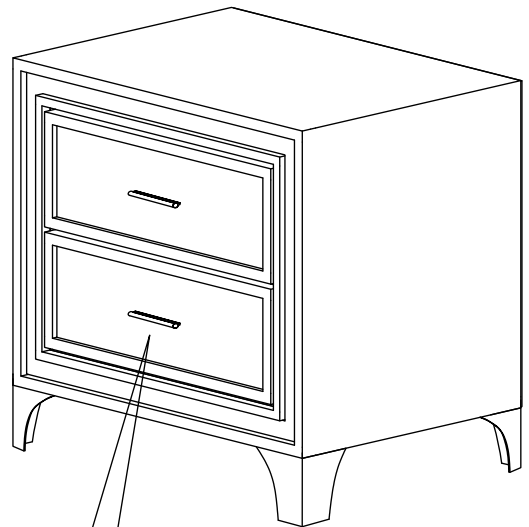

**COMPLETED
ASSEMBLY**

