

ASSEMBLY INSTRUCTIONS

SKU CODE: MG00039

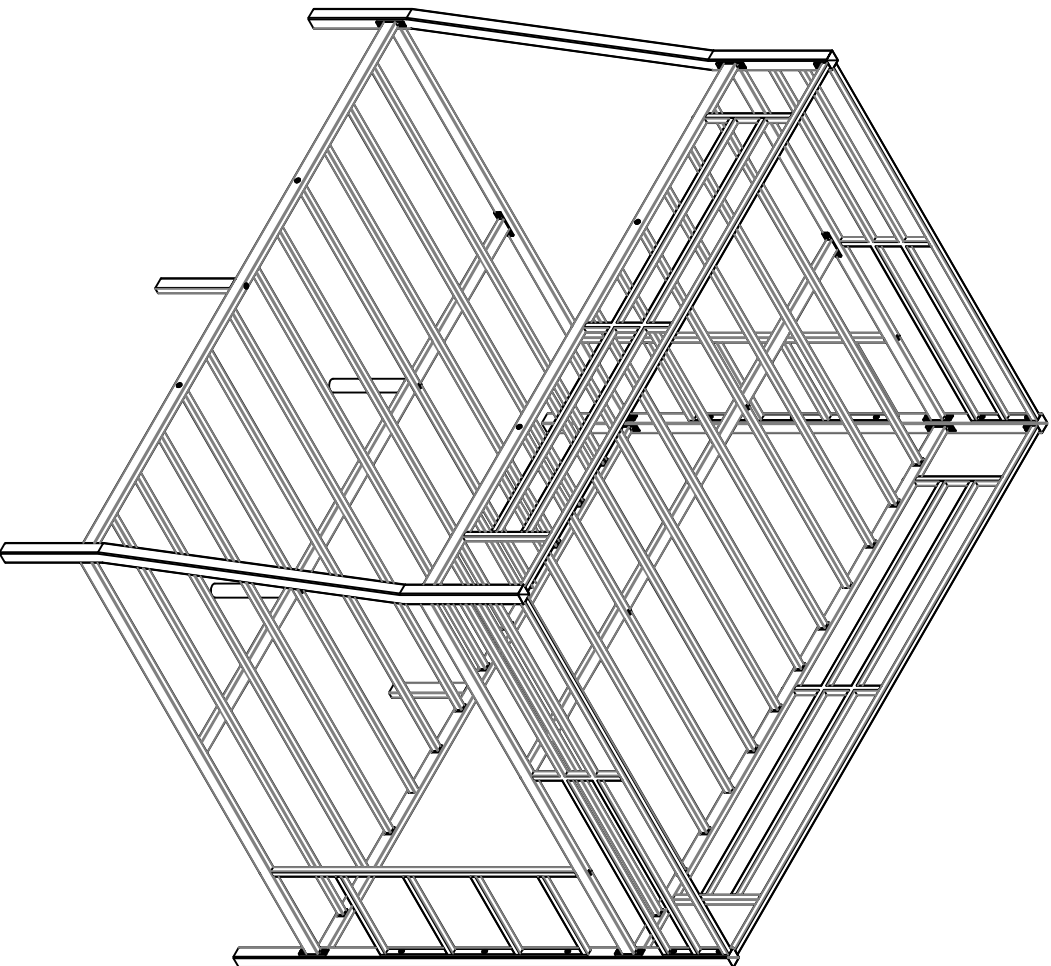



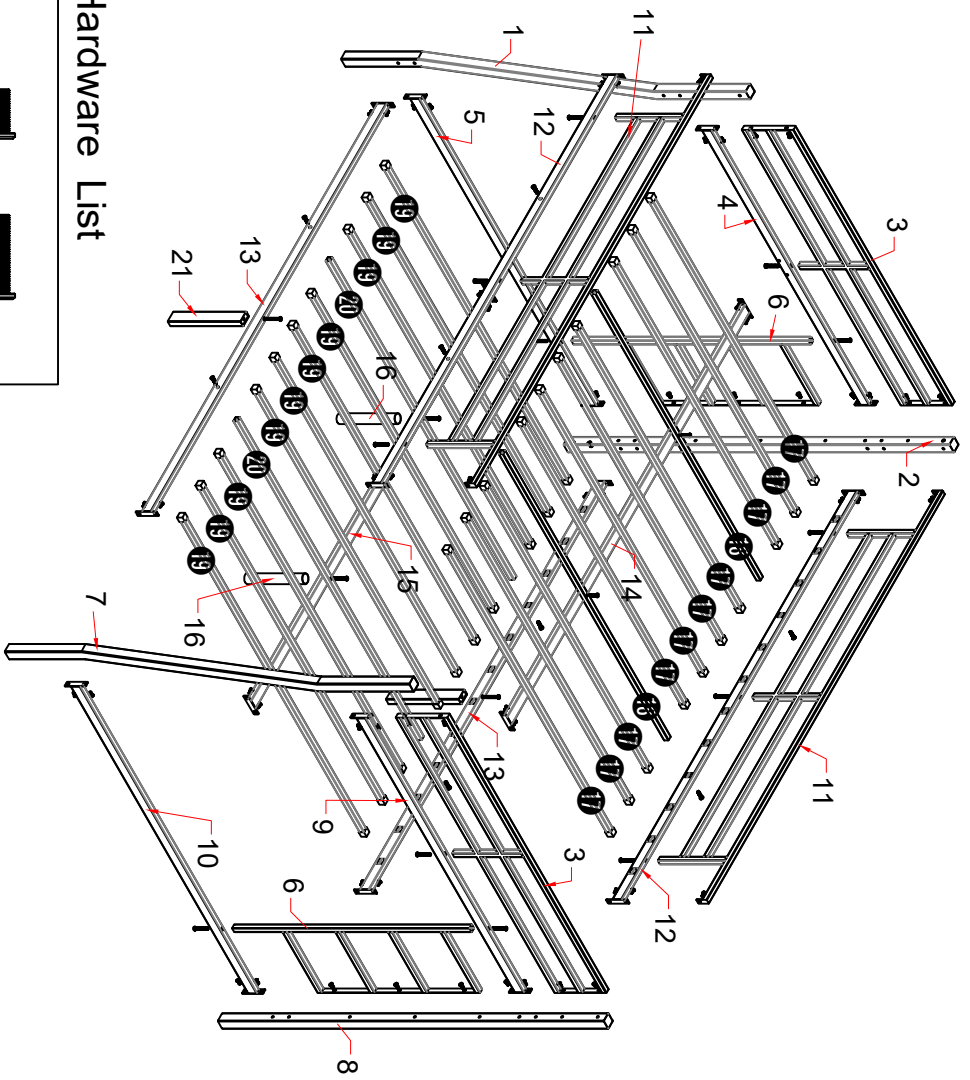

SAFETY WARNING













1. Follow the information on the warnings appearing on the upper bunk bed end structure and on the carton. Do not remove warning label from bed.
 2. Always use the recommended size mattresses or mattress supports, or both, to help prevent the likelihood of entrapment or falls.
 3. Do not allow children under 6 years of age to use the upper bunk.
 4. Periodically check and ensure that the guardrail, ladder, and other components are in their proper position, free from damage, and that all connectors are tight.
 5. Do not allow horseplay on or under the bed and prohibit jumping on the bed.
 6. Always use the ladder for entering and leaving the upper bunk.
 7. Do not use substitute part. Contact the manufacture or dealer for replacement part.
 8. Use of a night light may provide added safety precaution for a child using the upper bunk.
 9. Always use guardrails on both long sides of the upper bunk. If the bunk bed will be placed next to the wall, the guardrail that runs the full length of the bed should be placed against the wall to prevent entrapment between the bed and wall.
 10. The use of water or sleep flotation mattresses is prohibited.
 11. **STRANGULATION HAZARD** - Never attach or hang items to any part of the bunk bed that are not designed for use with the bed; for example, but not limited to, hook, belts and jump ropes.
 12. Keep these instruction for future reference.
 13. We recommend assembling your bunk bed on the shipping carton to protect your floor or carpet.
 14. Be certain all staples are out of the box before beginning assembly on the shipping carton.
 15. **USE ONLY MATTRESSES WHICH ARE AS THE ABLE BELOW ON UPPER AND ON LOWER BUNKS.**
- | Upper bed | Length | Width | Thickness | |
|----------------|------------------|-----------|----------------|-----------|
| Bed type | Full XL Standard | 79" - 80" | 53 1/2" 6" max | |
| Bottom bed | Bed type | Length | Width | Thickness |
| Queen Standard | 79" - 80" | 59 1/2" | 8" max | |
16. **SURFACE OF MATTRESS MUST BE AT LEAST 5" (127MM) BELOW THE UPPER EDGE OF GUARDRAILS.**

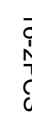

Hardware List

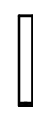
-  A-58PCS
-  B-10PCS
-  C-16PCS
-  D-40PCS
-  E-1PC

Part List

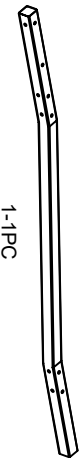

1-1PC



2-1PC



3-2PCS



4-1PC



5-1PC

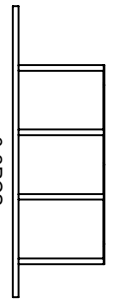

6-2PCS



7-1PC

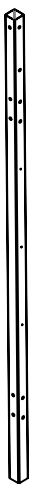

8-1PC



9-1PC



10-1PC

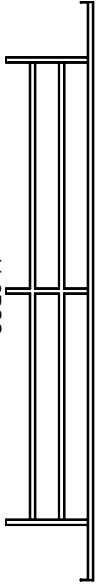

11-2PCS



12-2PCS



13-2PCS

Step 1

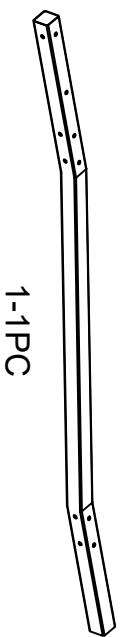
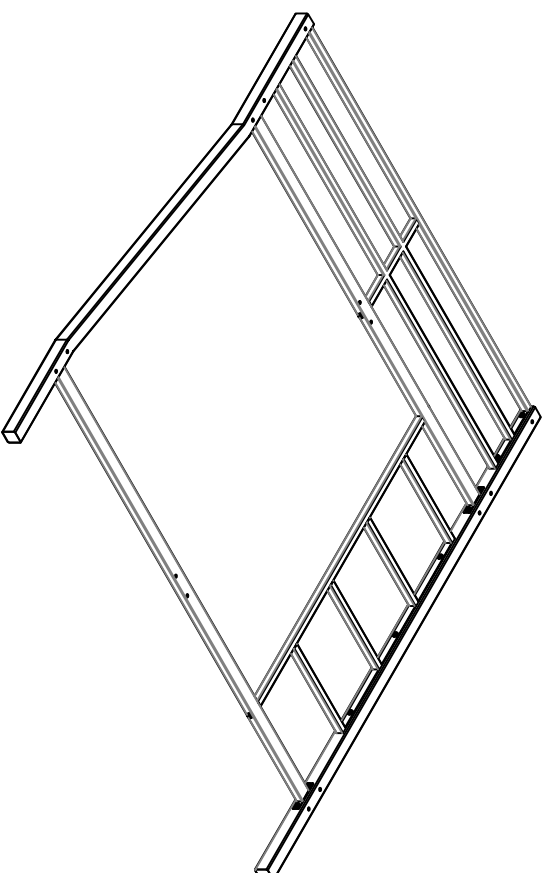
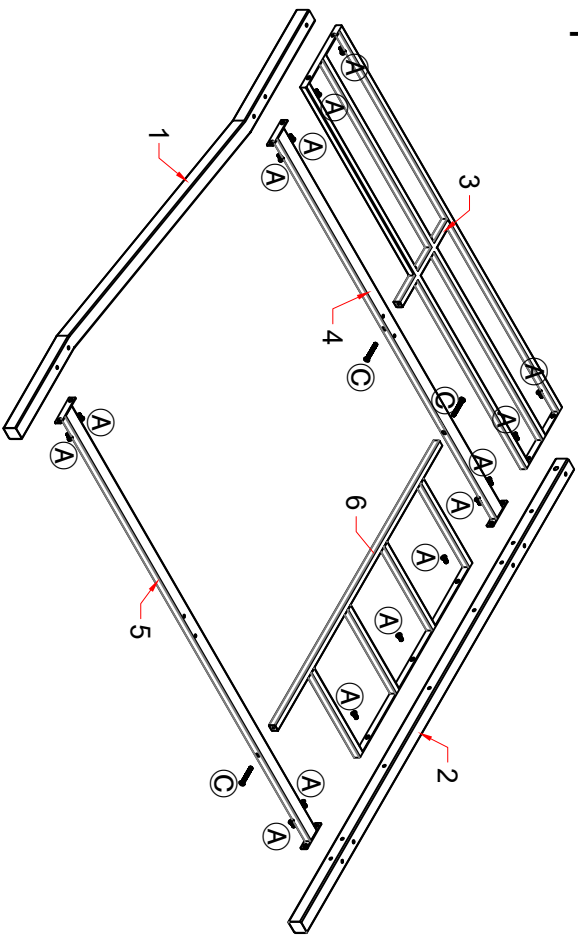

1-1PC

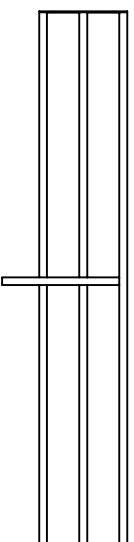

3-1PC



2-1PC

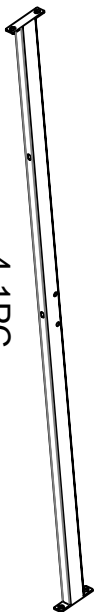

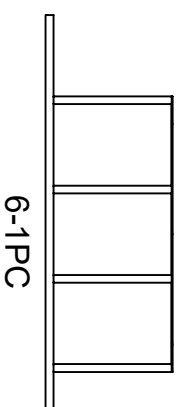

4-1PC

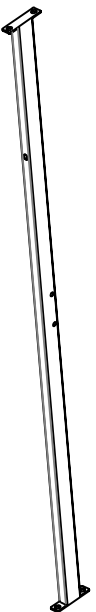

6-1PC



5-1PC

 A-15PCS
  C-15PCS

Step 2

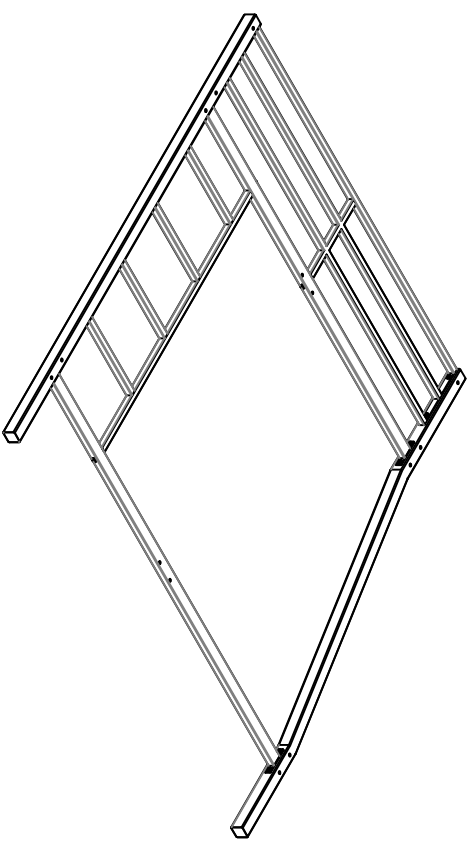
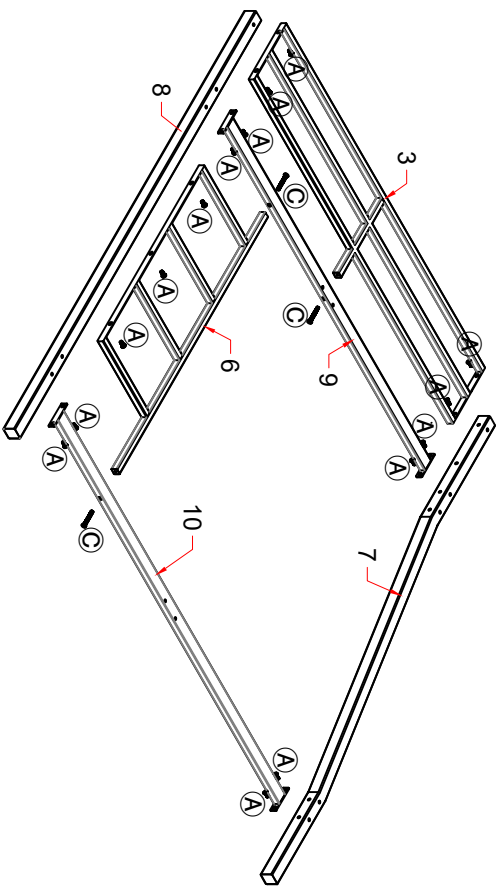

7-1PC

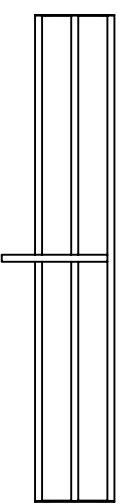

3-1PC



8-1PC

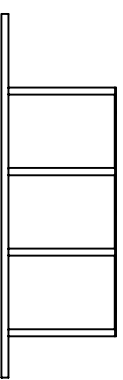

6-1PC



9-1PC



A-15PCS



C-15PCS

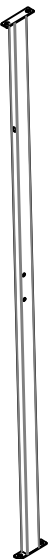

10-1PC

Step 3

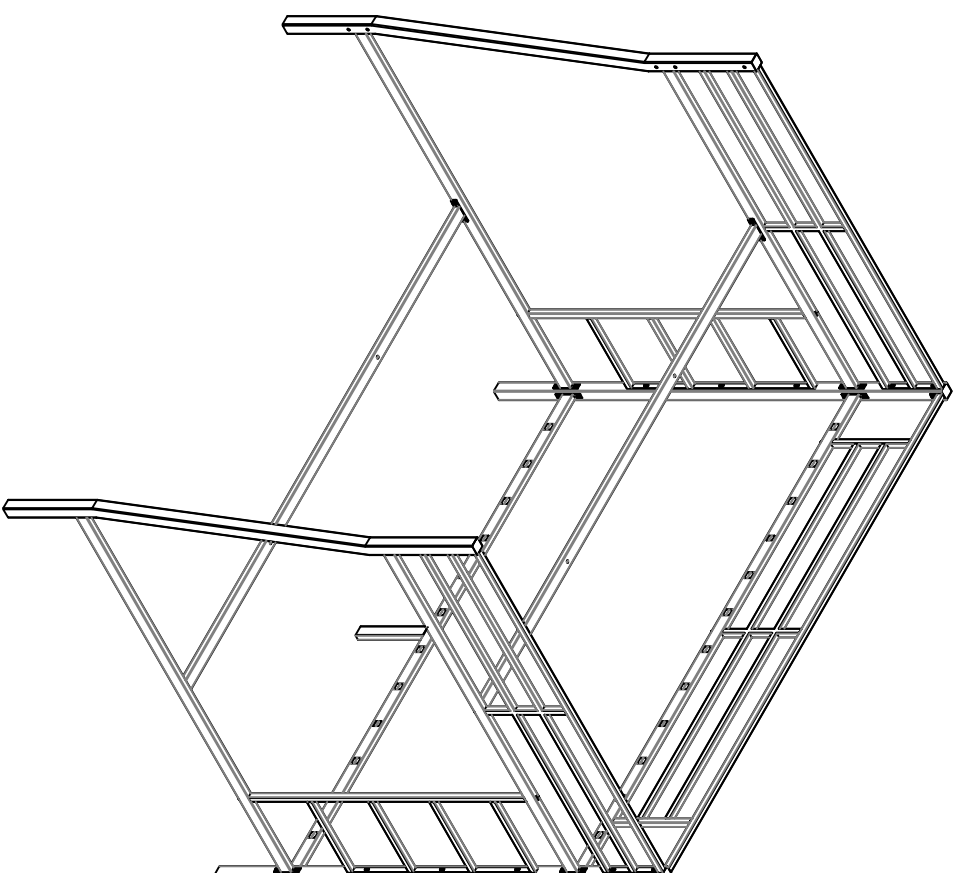
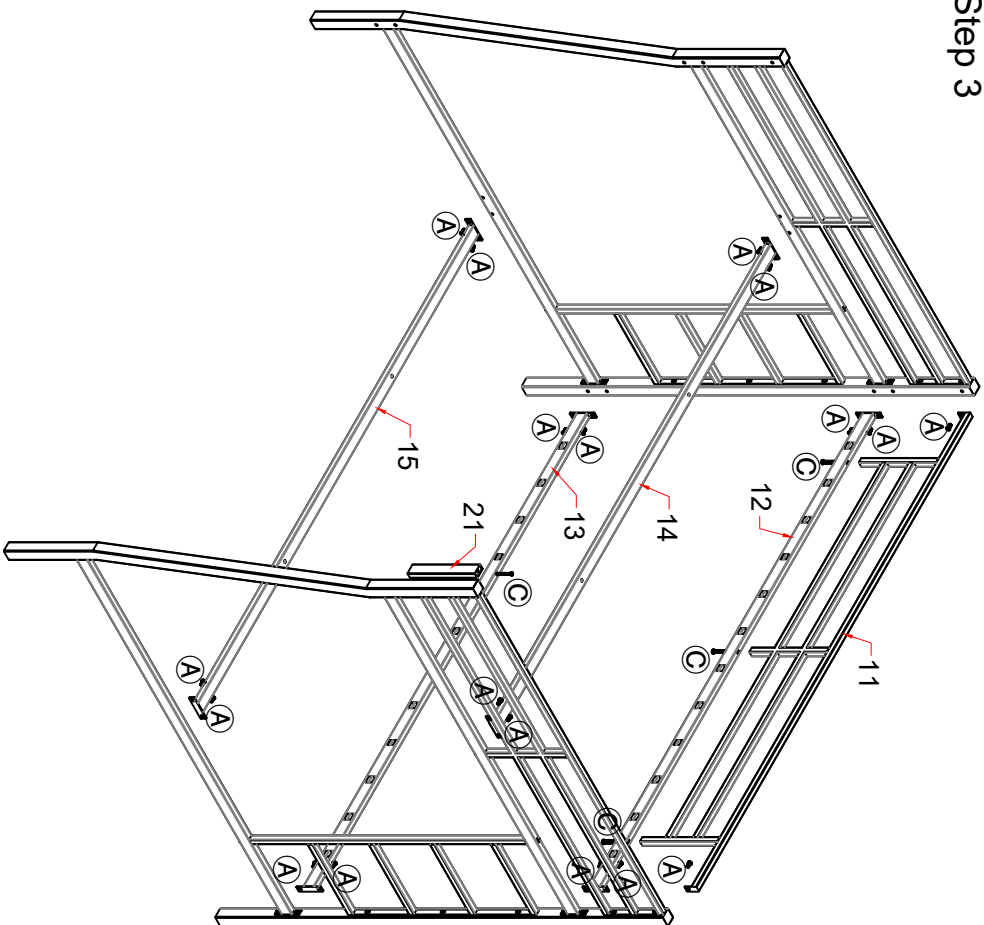

12-1PC



14-1PC

单面孔



13-1PC



15-1PC

双面孔

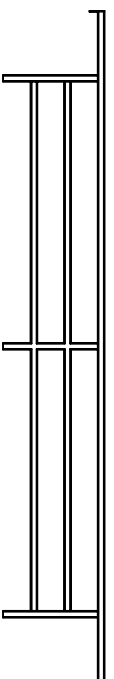

11-1PC



21-1PC



A-18PCS



C-4PCS

Step 4

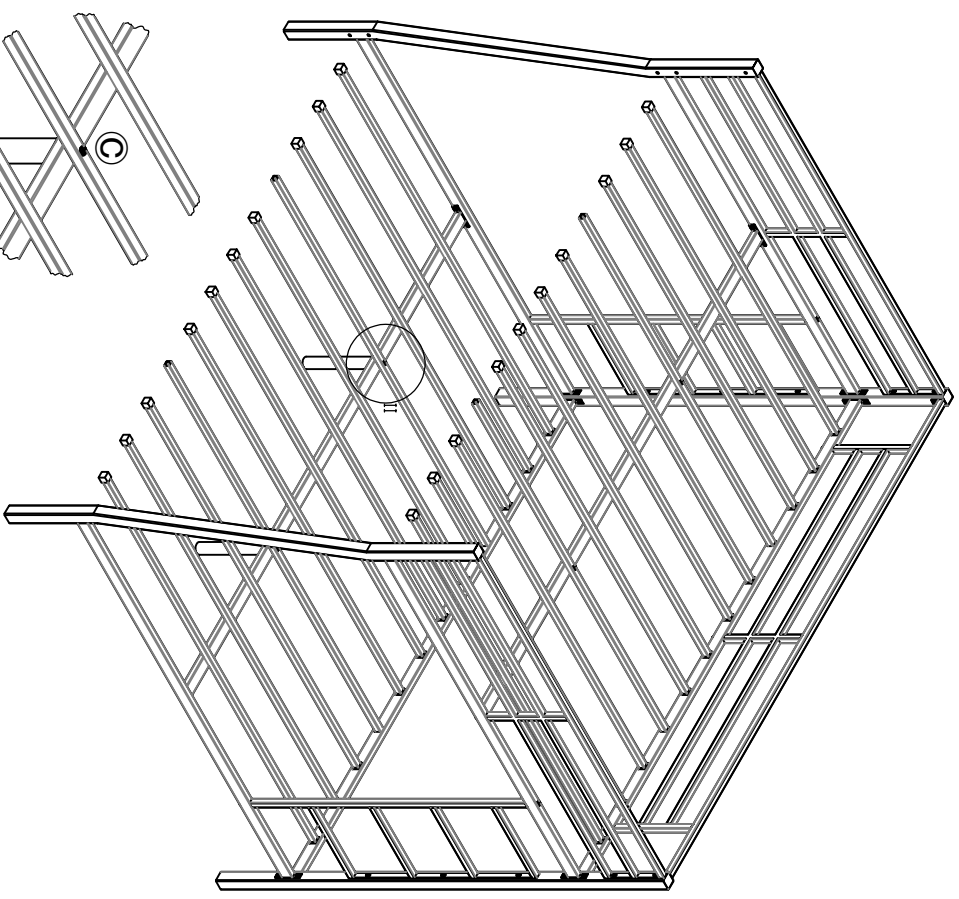
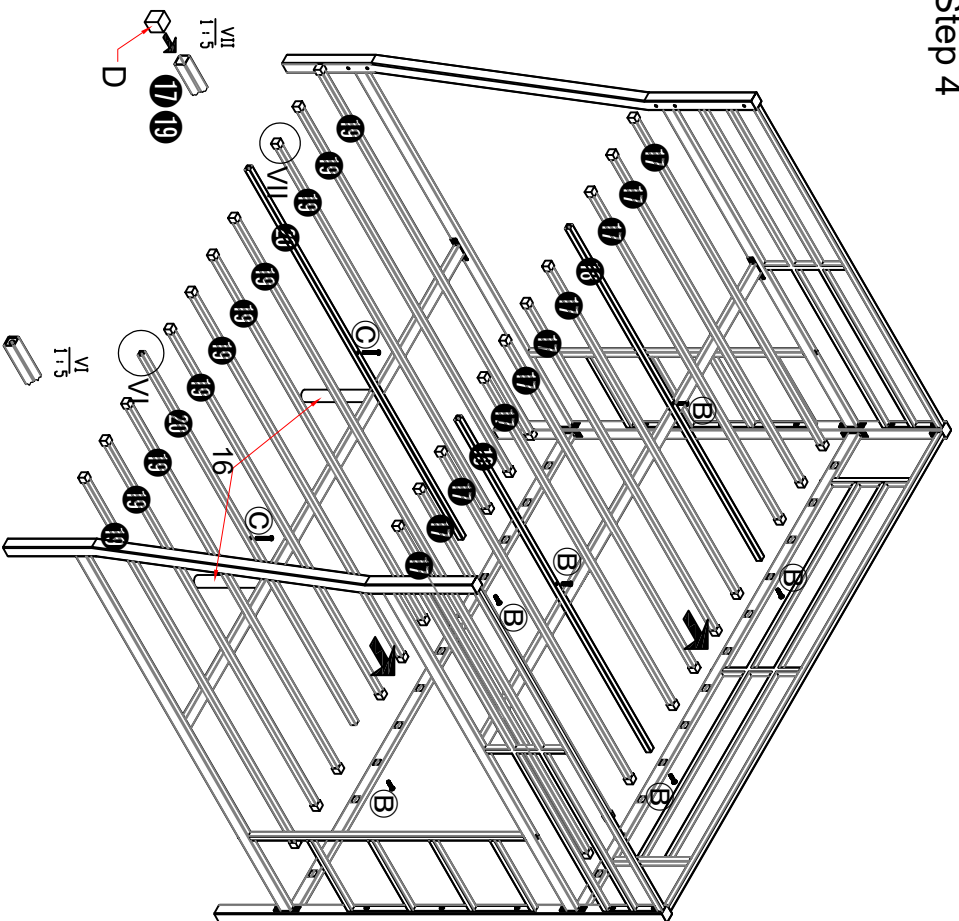

17-10PCS

18-2PCS



16-2PCS

19-10PCS



B-6PCS C-2PCS D-40PCS

20-2PCS



Step 5

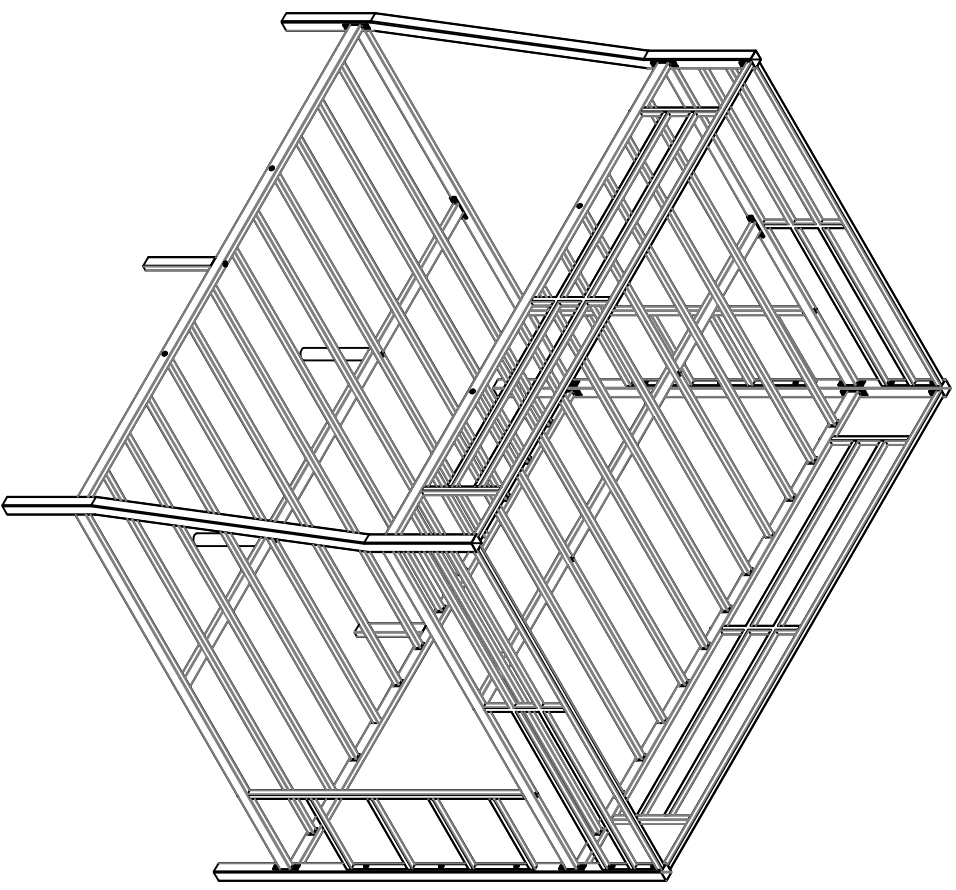
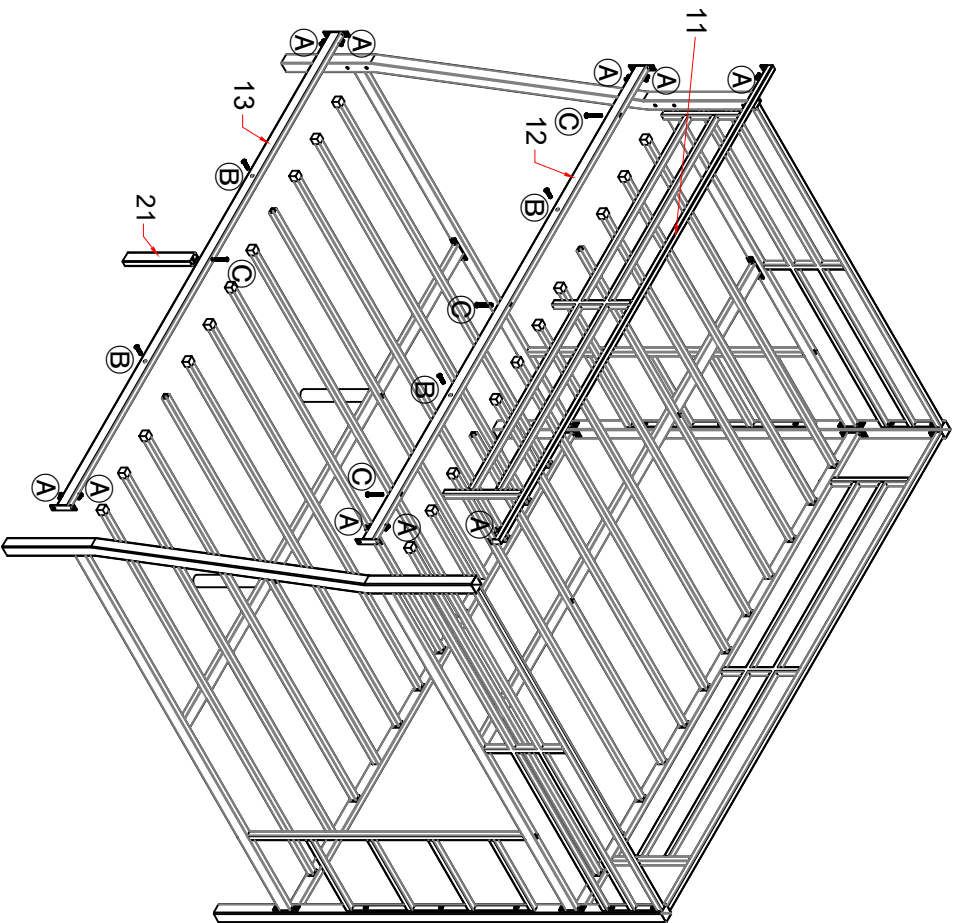

12-1PC



13-1PC

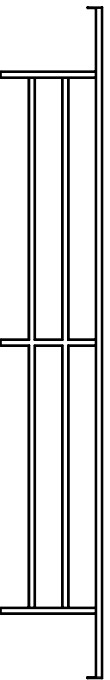

11-1PC



21-1PC



A-10PCS



B-4PCS



C-4PCS