



# ASSEMBLY INSTRUCTIONS FOR ACME FURNITURE



## MODEL#DN02312

Thank you for purchasing the quality product. Be sure to check all packing material carefully for small parts which may have come loose inside the carton during shipment. Separate, identify and count all parts and metal hardware. Compare with all parts list to be sure all parts are present. If any part(s) are missing or damaged, please contact your local furniture dealer. For efficient and speedy service, please indicate the model number and code letter of part(s) needed.

\*\*\* Do not fully tighten screws until fully assembled \*\*\*

DESCRIPTION	COMPONENT PARTS		Q'TY(PCS)
	PART NAME		
①	TABLE TOP		1
②	TABLE LEG (L/R)		4

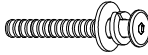
### HARDWARE REQUIRED

- A  JCBB M8 x 70mm + S/W 5/16" + F/W 5/16" x 22mm 8 PCS
- B  ALLEN KEY M5 1 PC
- C  PVC NAIL 5/8" 4 PCS

### TOOLS NEEDED

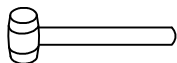
-  (NOT PROVIDED)

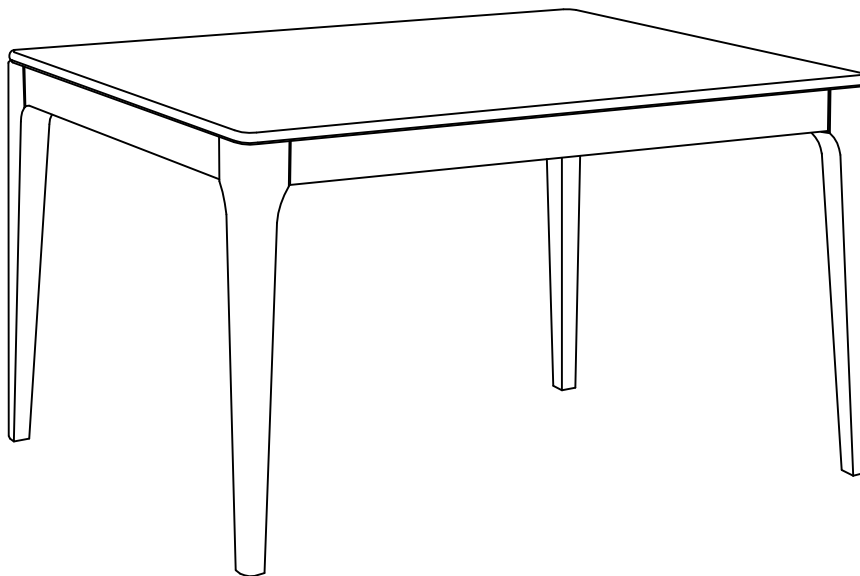

### Attention

\*\* Some number parts listed on the instruction sheet may not be in parts bag as they may already be assembled. Carefully check parts and packing materials prior to ordering replacements.

# How to assemble:

## STEP 1

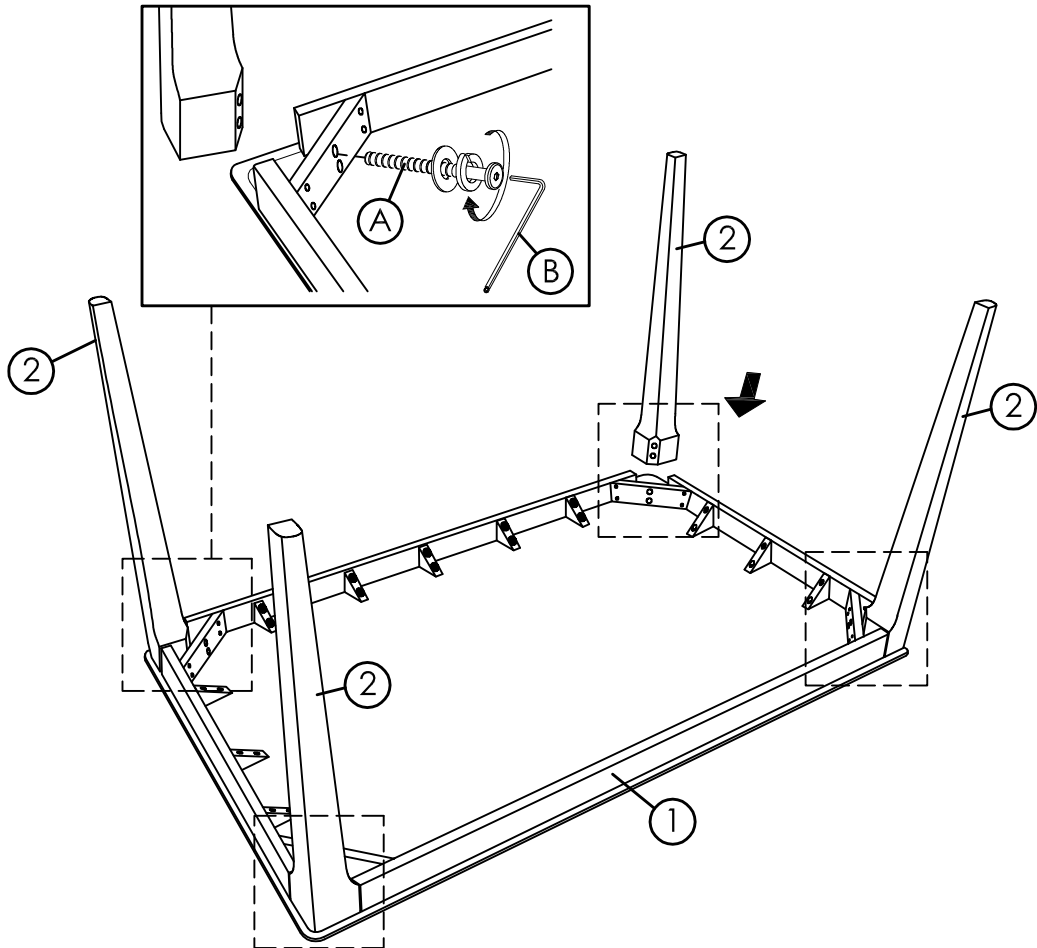

## STEP 2

