

Top View

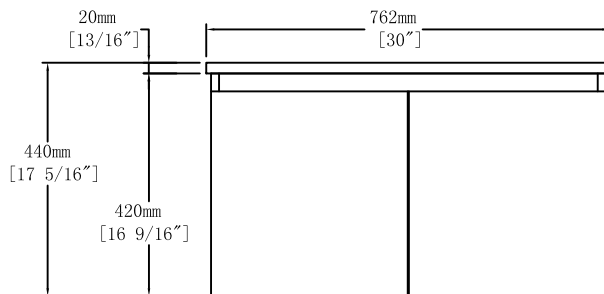

Front View

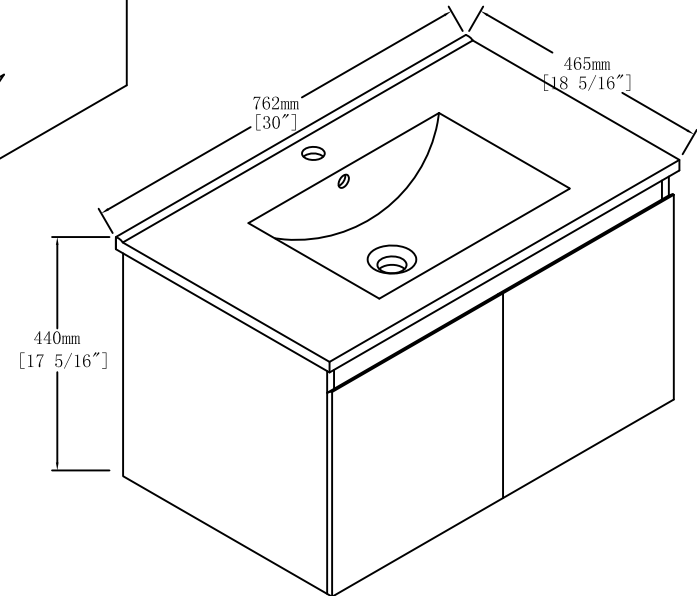
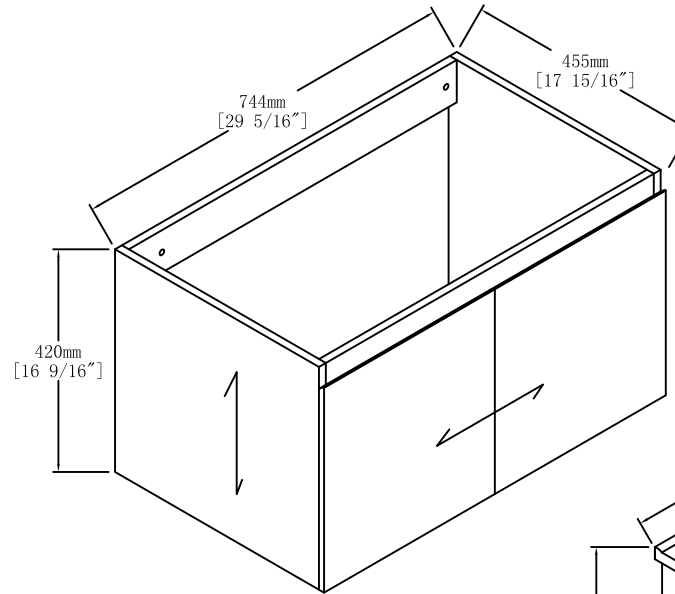
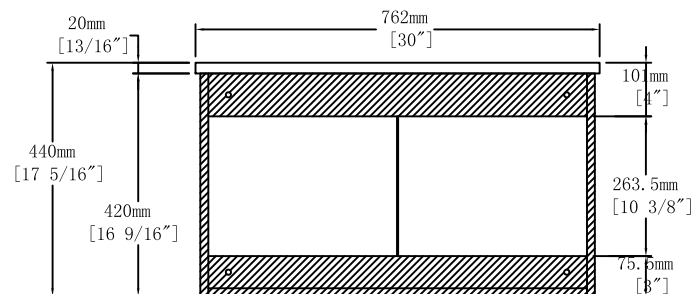

Back View



Item NO.

BV B07930

Version

V1

Project

Date

2023-12-25