

Top View

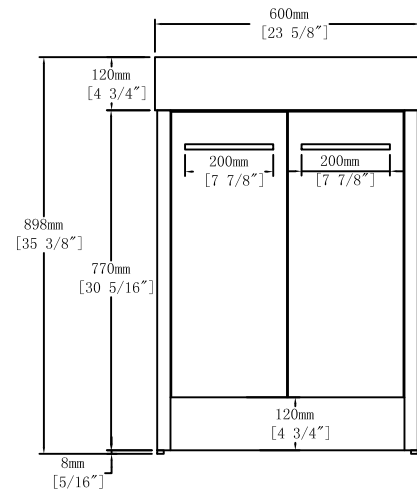

Front View

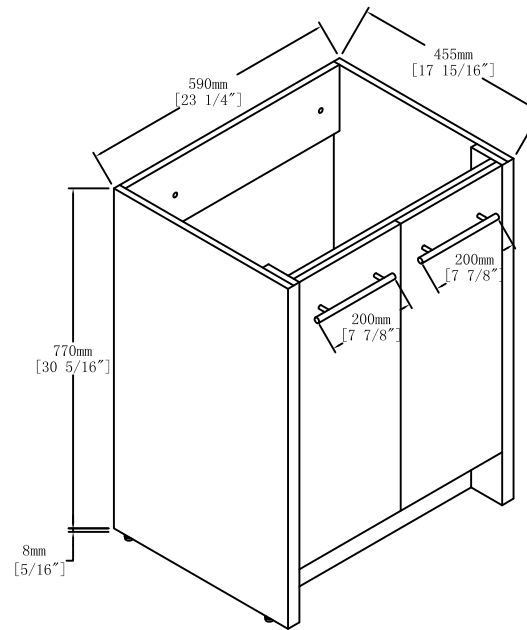
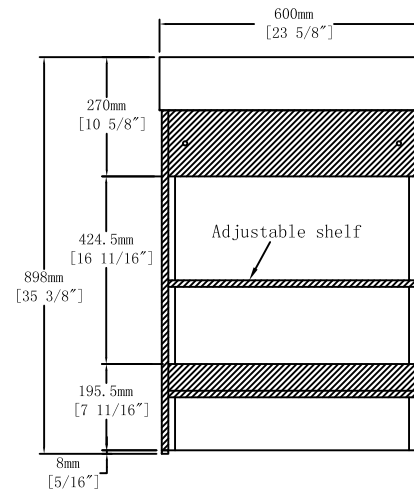

Back View

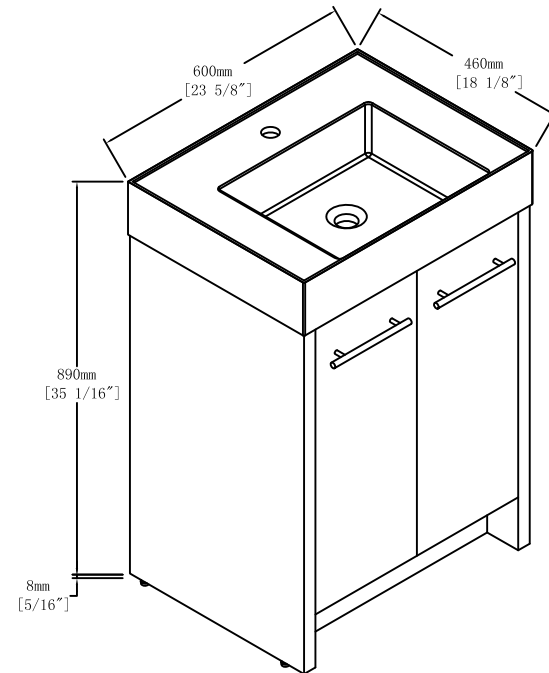

Item NO.

BV B09224

Version

V1

Project

Date

2024-3-31