

Top View

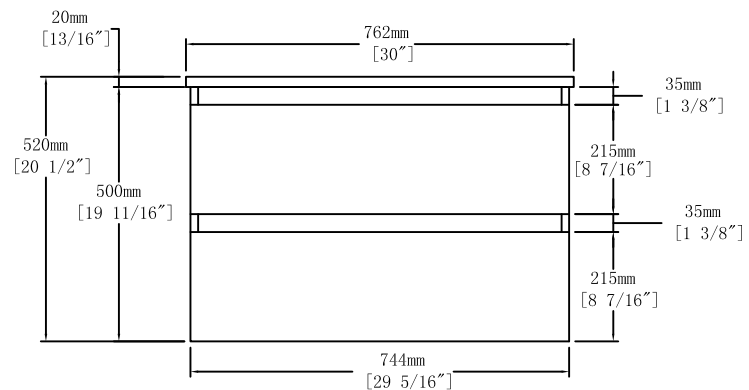

Front View

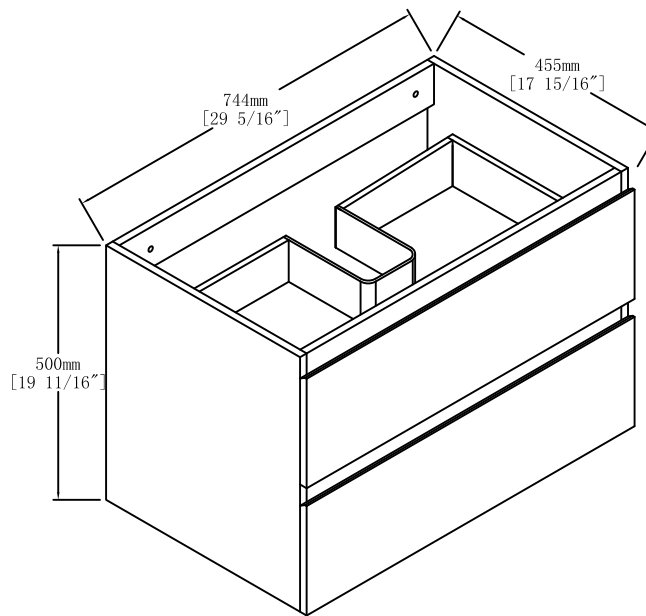
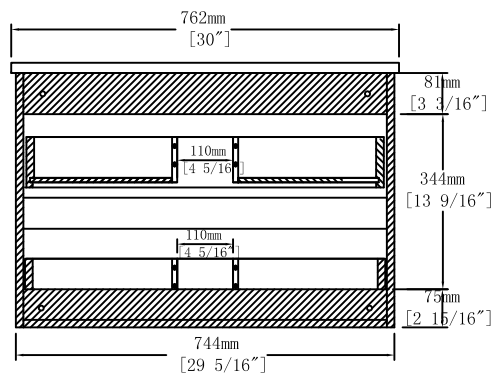

Back View

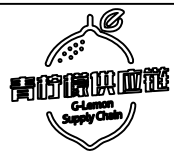
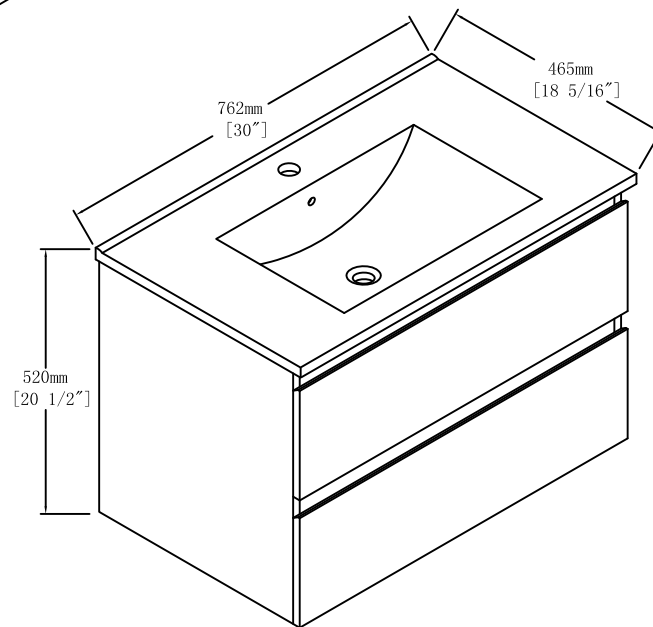

Item NO.	BV B01930-1	Version	V1
Project		Date	2024-3-19