

Top View

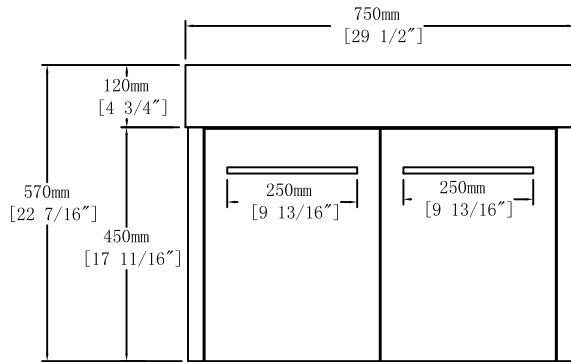

Front View

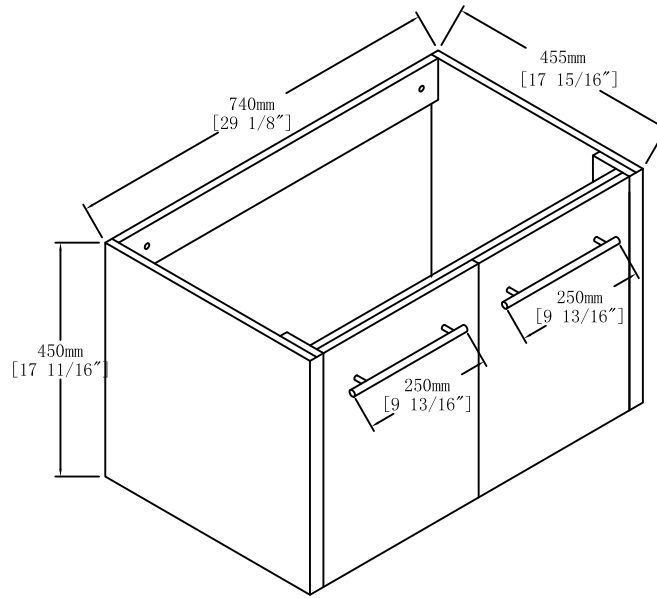
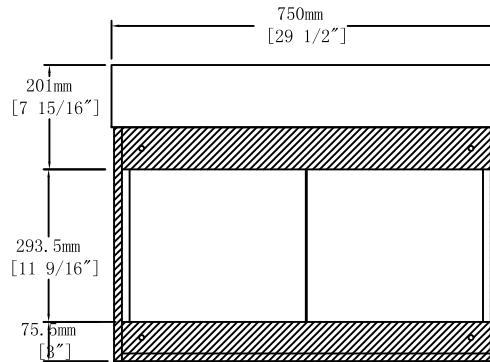

Back View

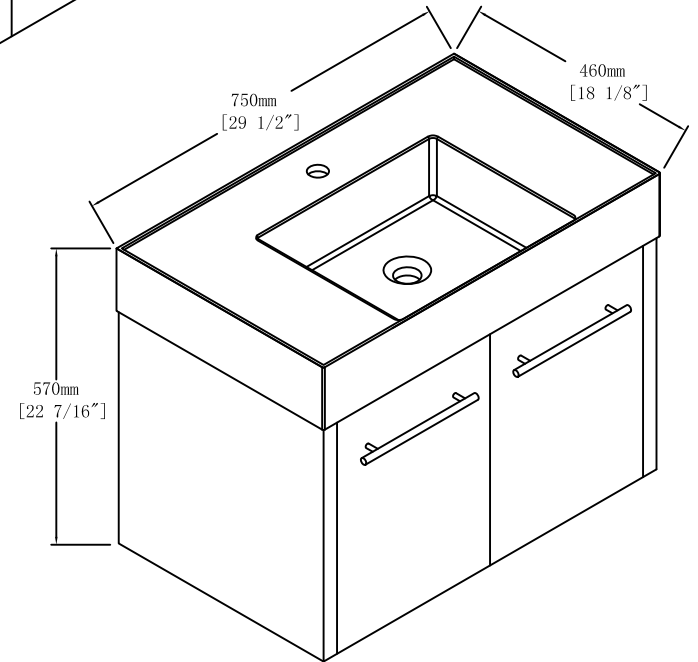

Item NO.	BV B09130
Project	

Version	V1
Date	2024-1-24