

Top View

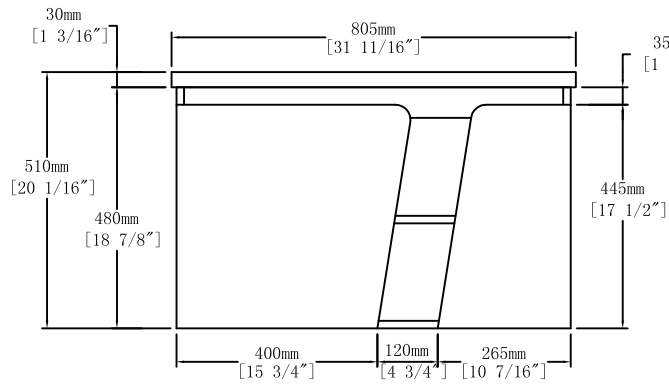

Front View

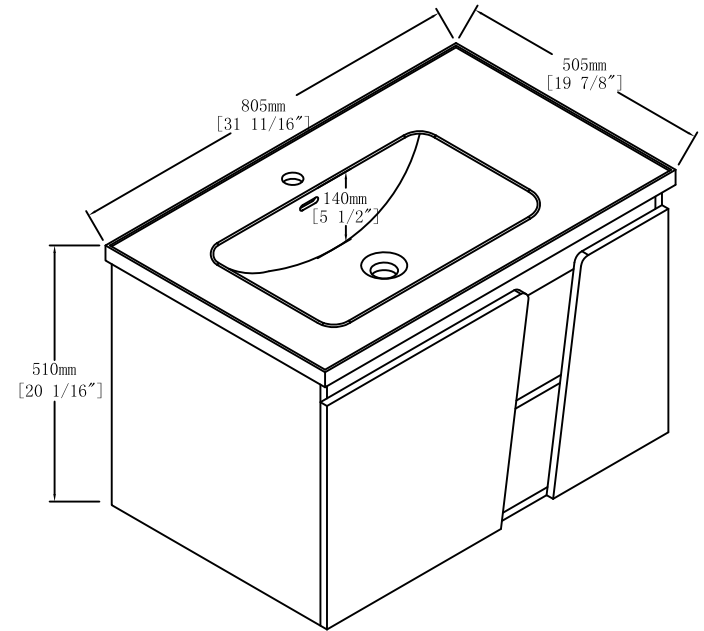
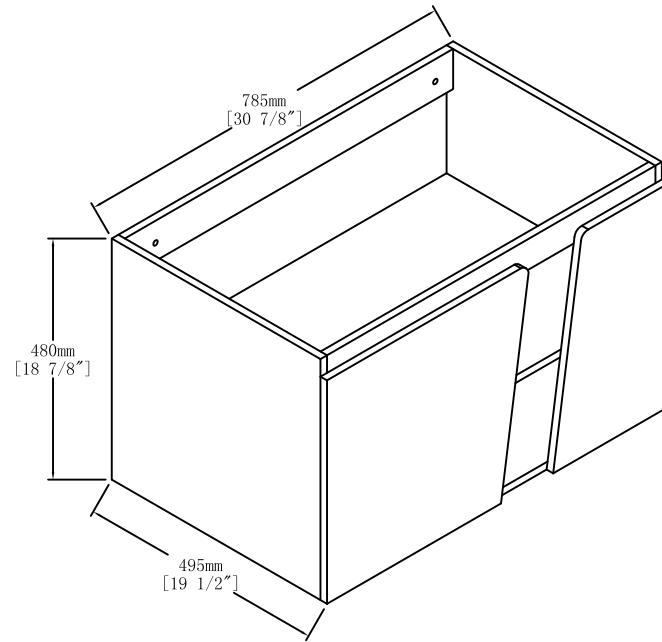
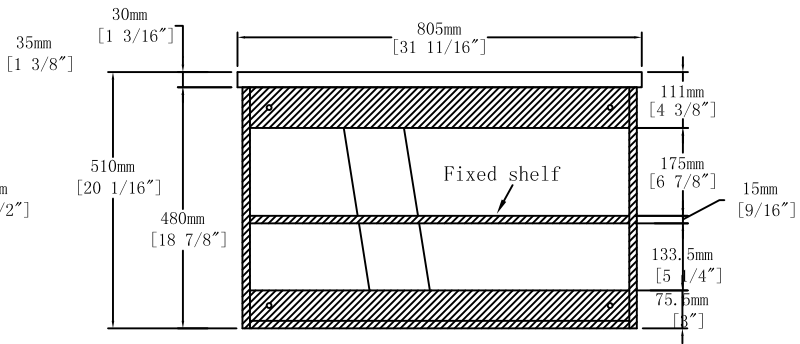

Back View



Item NO.

BV B08432

Version

V1

Project

Date

2023-12-18