

Top View

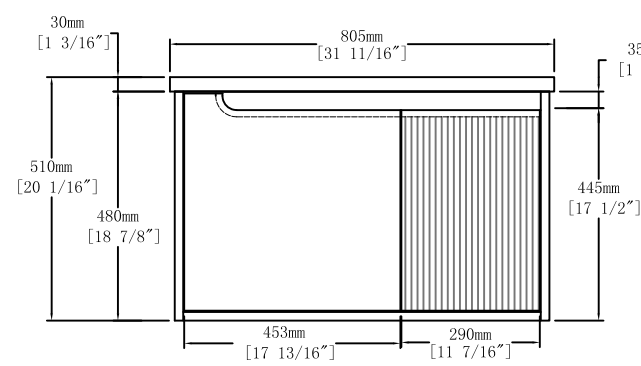

Front View

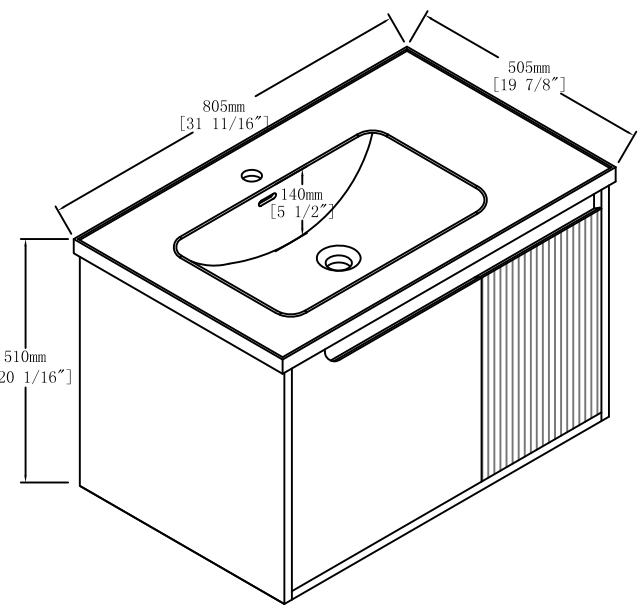
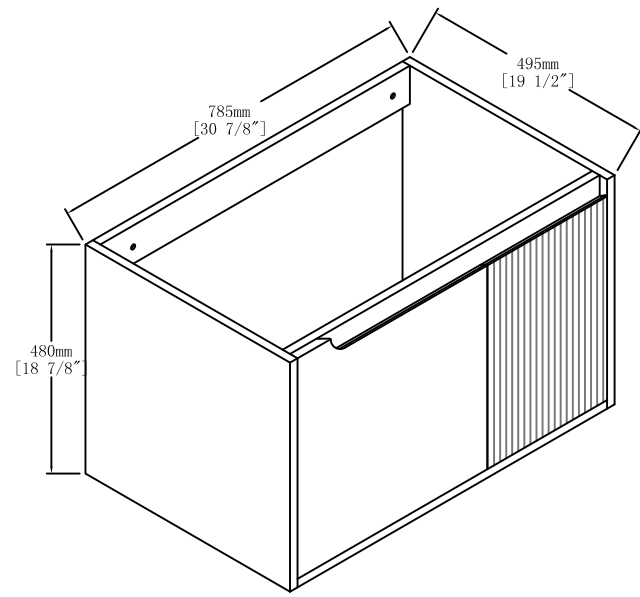
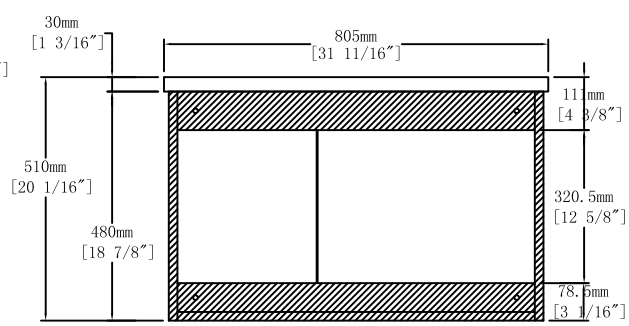

Back View

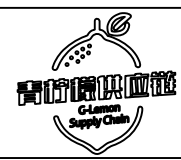

	Item NO.	BV B08832	Version	V1
	Project		Date	2023-12-19