

Top View

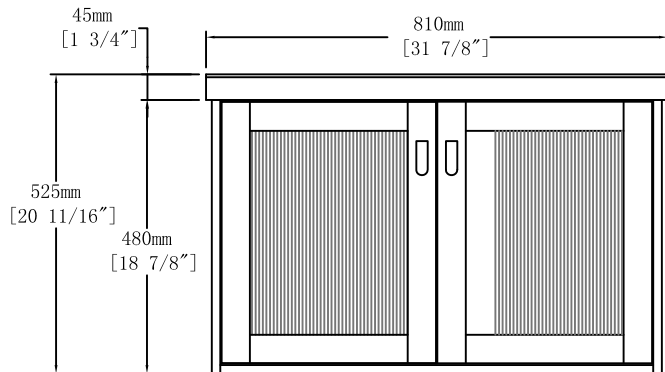

Front View

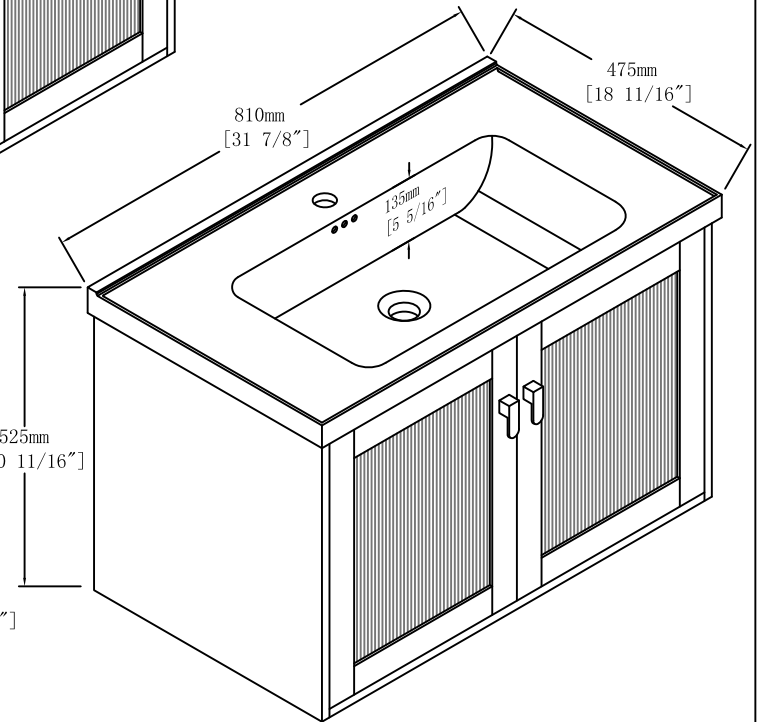
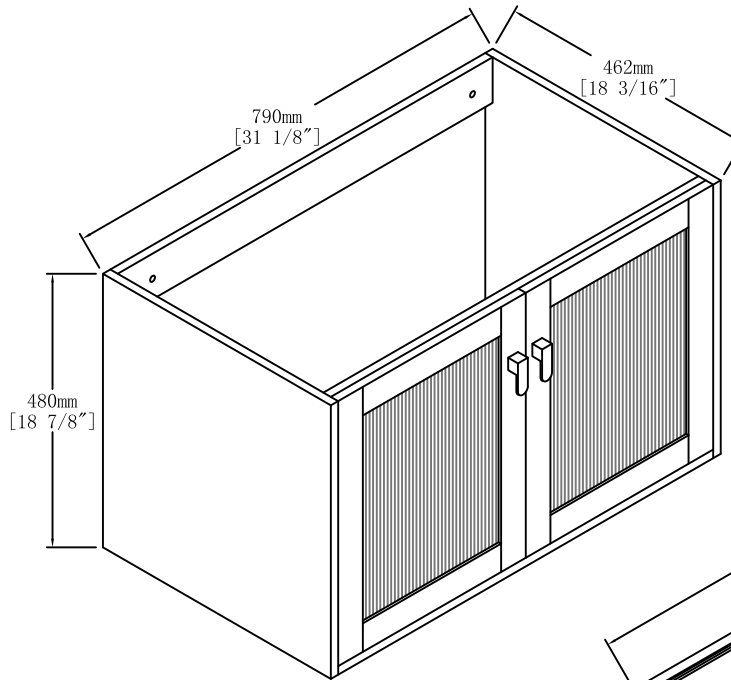
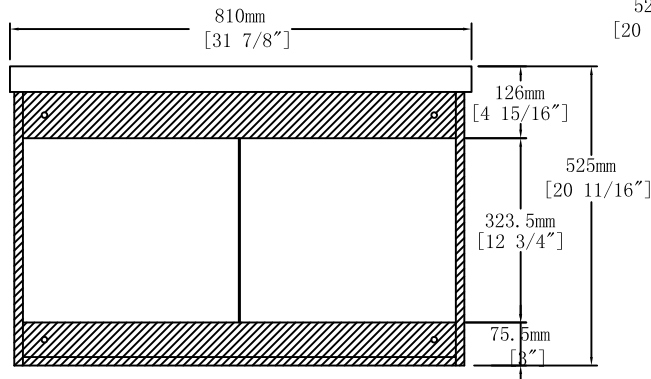

Back View



Item NO. BV B08232

Project

Version V1

Date 2023-11-15