

Top View

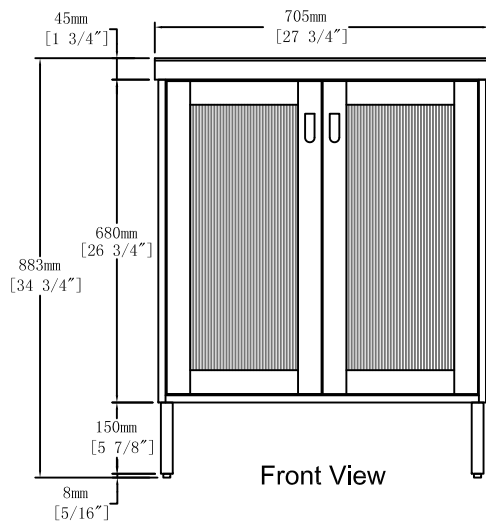

Front View

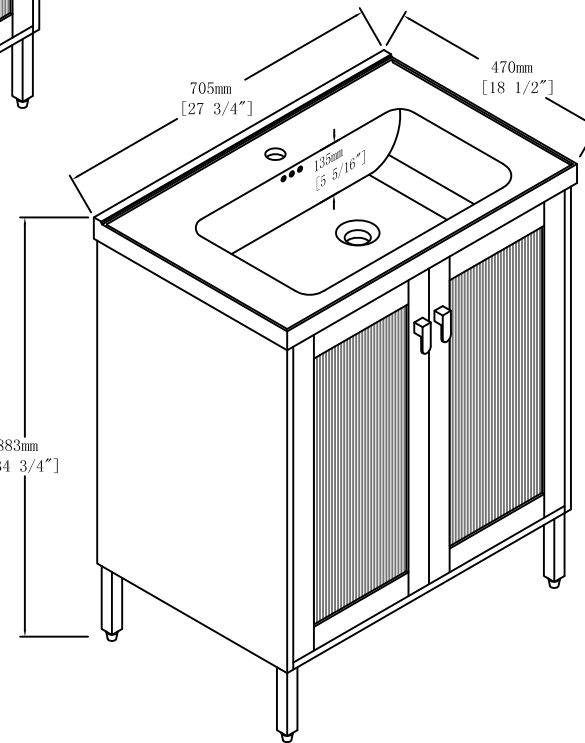
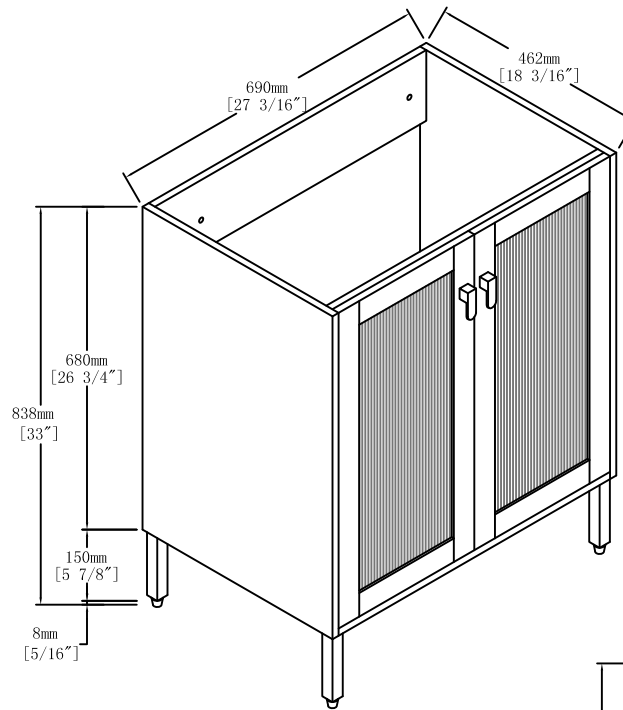
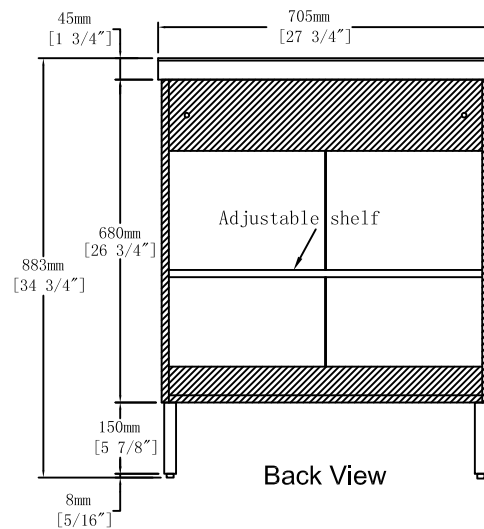

Back View



Item NO.

BV B08328

Version

V1

Project

Date

2023-11-15