

Top View

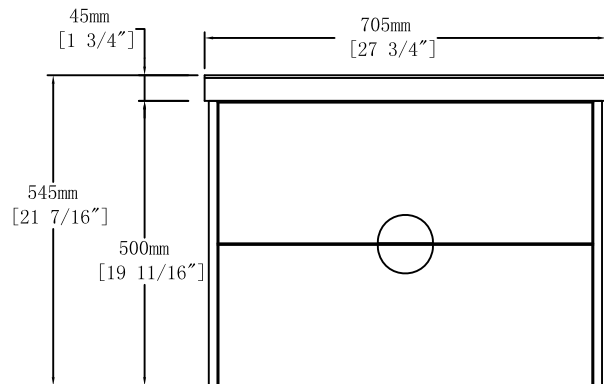

Front View

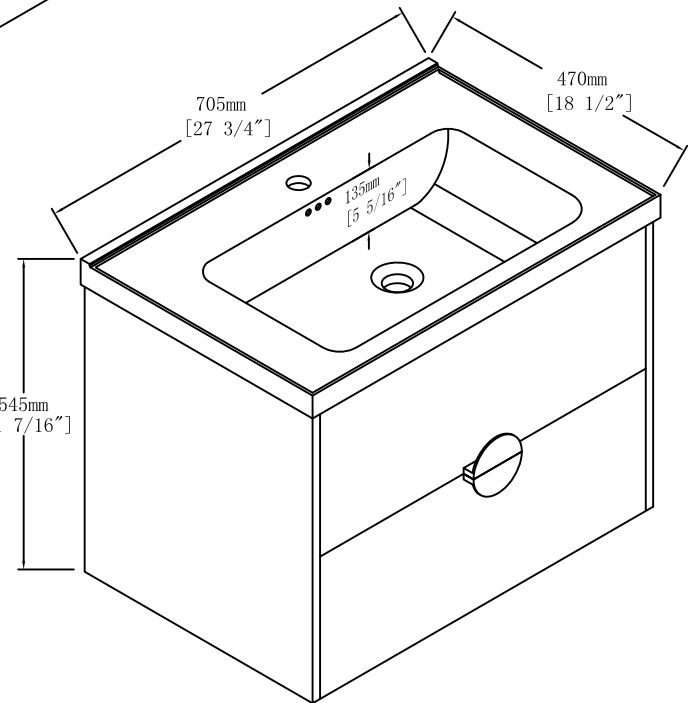
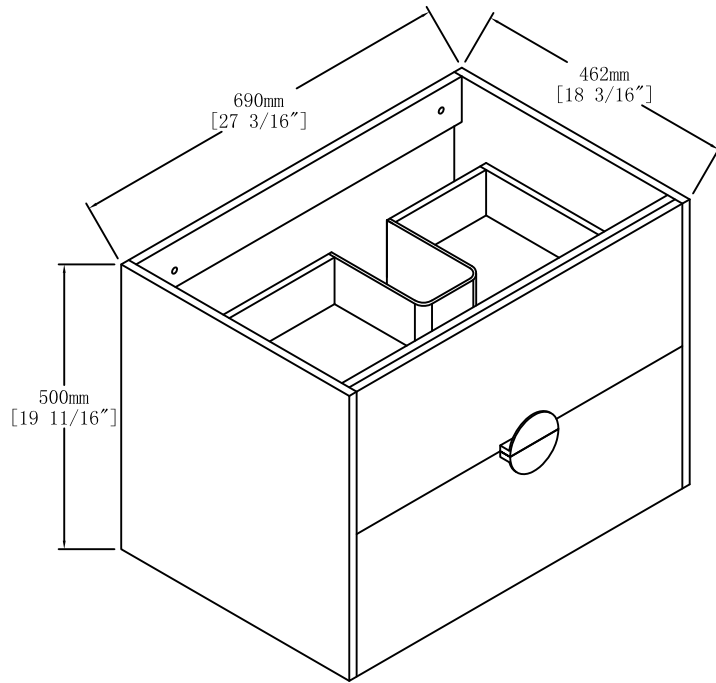
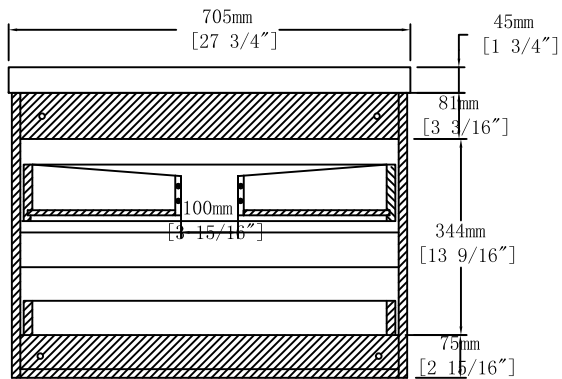

Back View



Item NO.

BV C07628

Version

V1

Project

Date

2023-10-5