

Top View

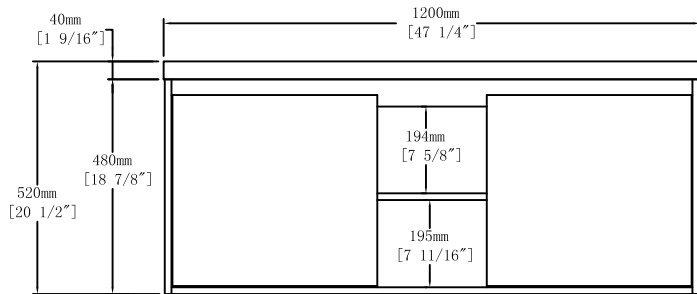

Front View

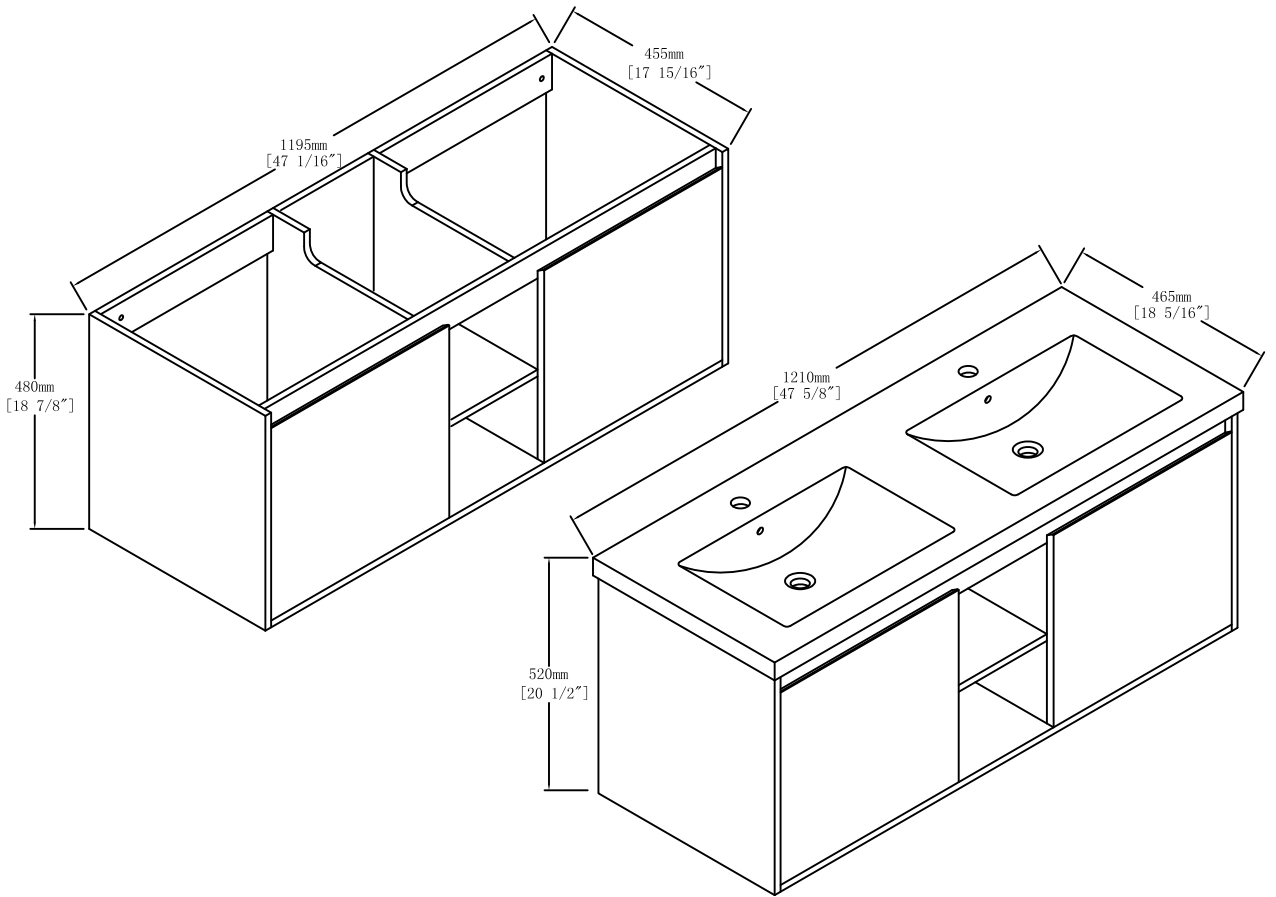
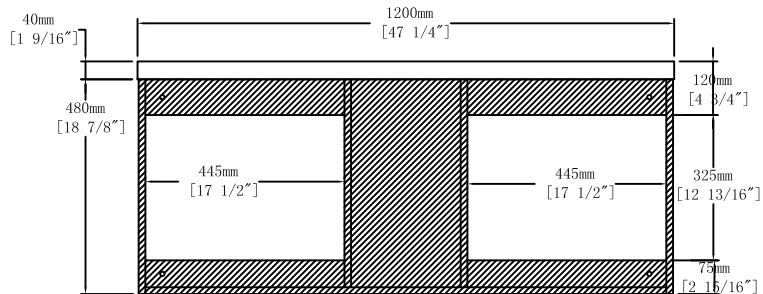

Back View



Item NO.

BV B07248

Version

V1

Project

Date

2023-8-6