

Top View

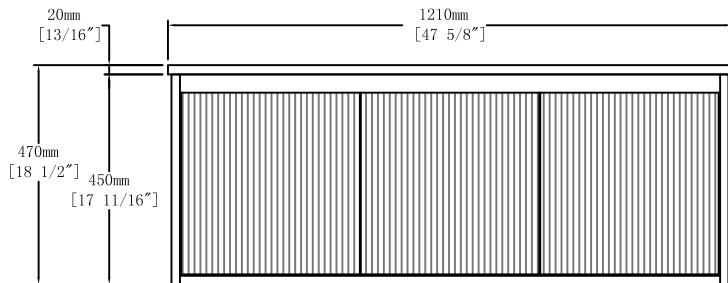

Front View

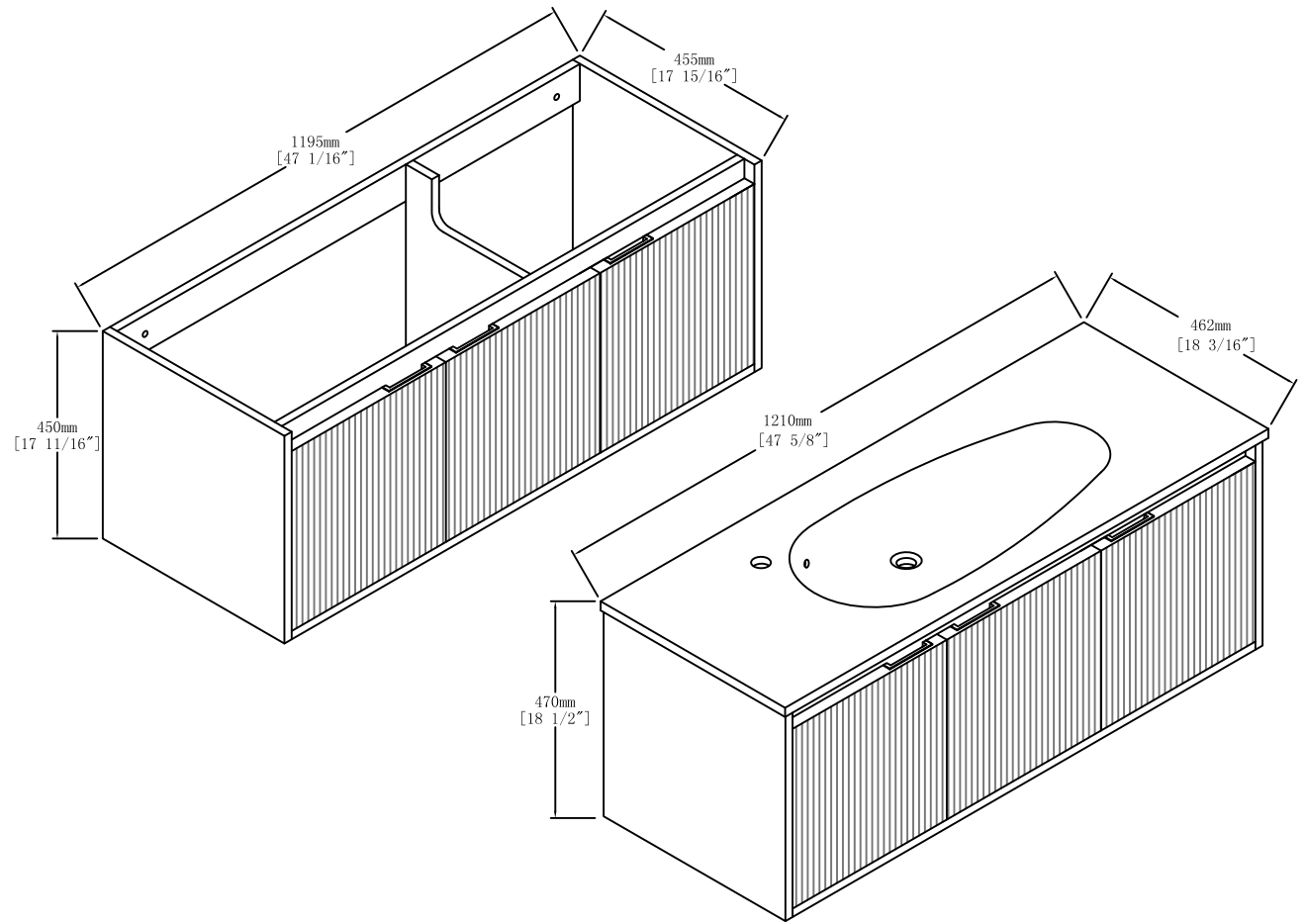
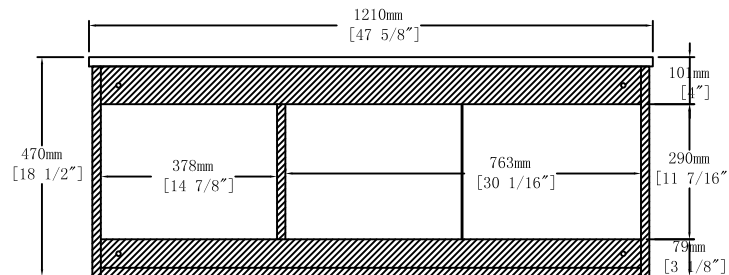

Back View



Item NO.

BV B05848

Version

V1

Projece

Date

2023-5-4