

THANKS FOR WATCHING

Your feedback is invaluable to us and we would love to hear about your experience. Please take the time to leave us a review.

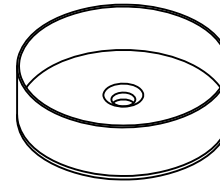

BA B400MO WH

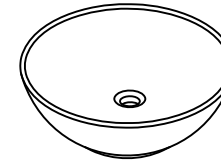

BA B321MO WH

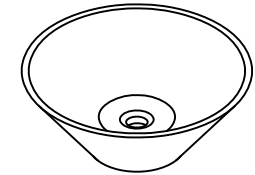

BA B217MO WH

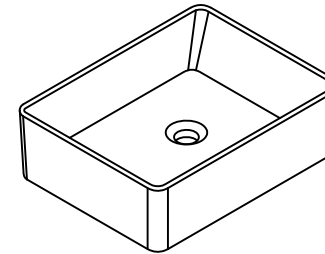

BA B110MO WH

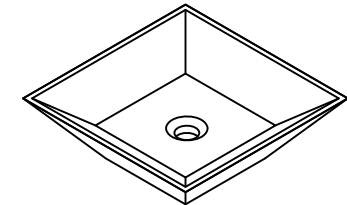

BA B101MO WH

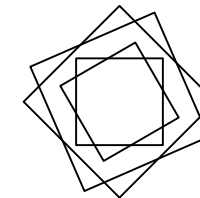

Thank you for shopping with us!

We encourage you to take a few minutes to go through this booklet. It contains important information on installation and care tips to keep your furniture looking as good as new.

Item NO.: Art ceramic basin

Dimensions

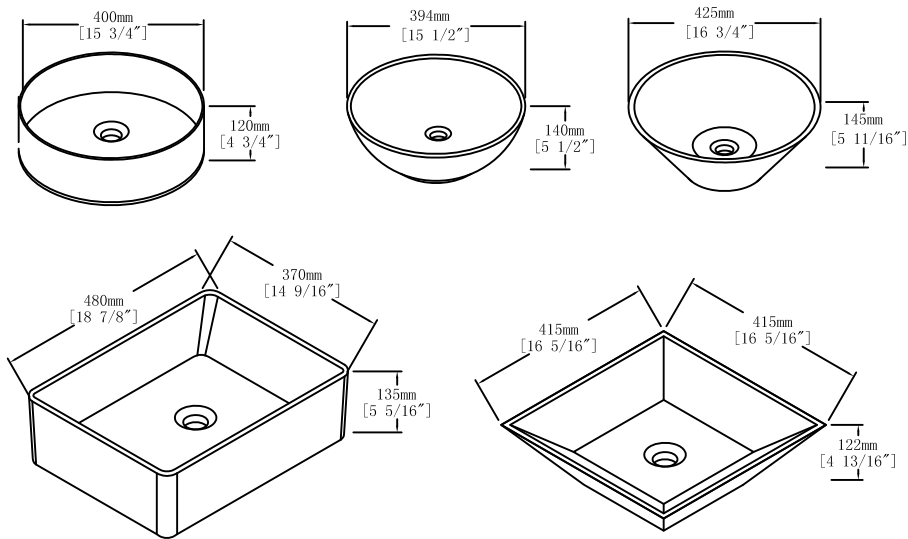

10mm size tolerance due to clay absorbtion

Recommended tools

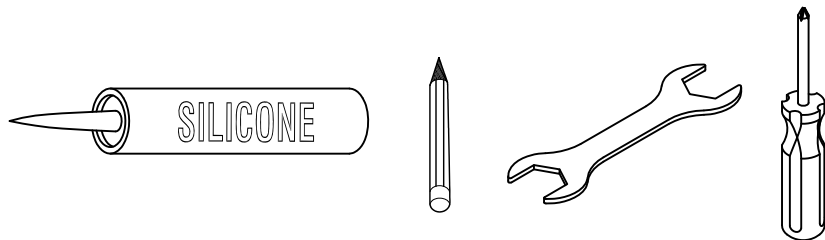

Installation

Primary Material : Ceramic

How to Install

If you are installing a vessel faucet with your vessel sink, you should install the faucet first. Once the faucet is installed, position the sink on the countertop. Then use the sink mounting ring and hardware to hold and secure the sink to the countertop (make sure someone is helping you. Lastly, connect the drain from the inside of the sink and then connect the p-trap to the bottom of the drain.

CARE CLEANING AND MAINTENANCE

1. Do not cut the surface of the basin with sharp objects.
2. Do not use cleaners , ammonia compounds and solvents.
3. Use safe damp cloth.
4. Do not use gritty scouring pads.