

Top View

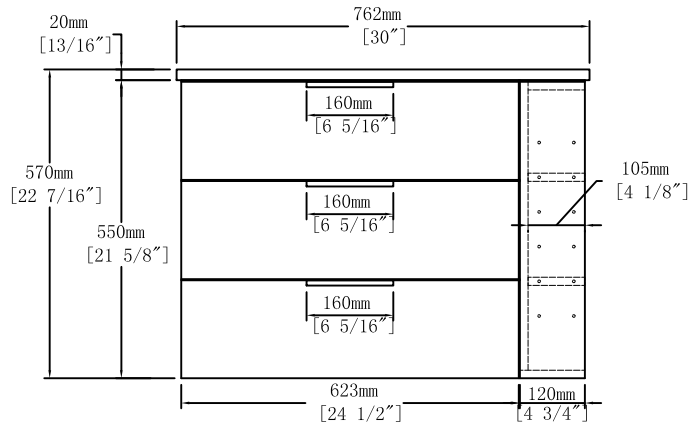

Front View

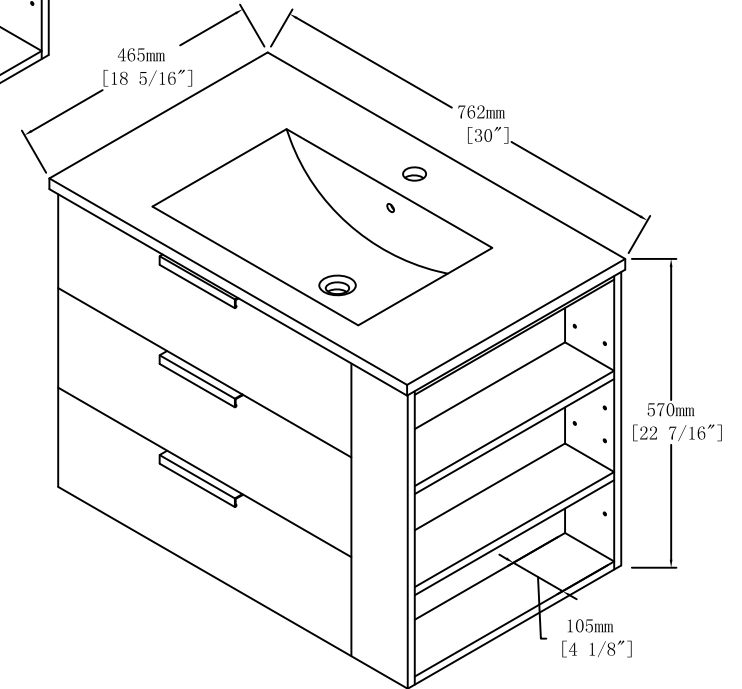
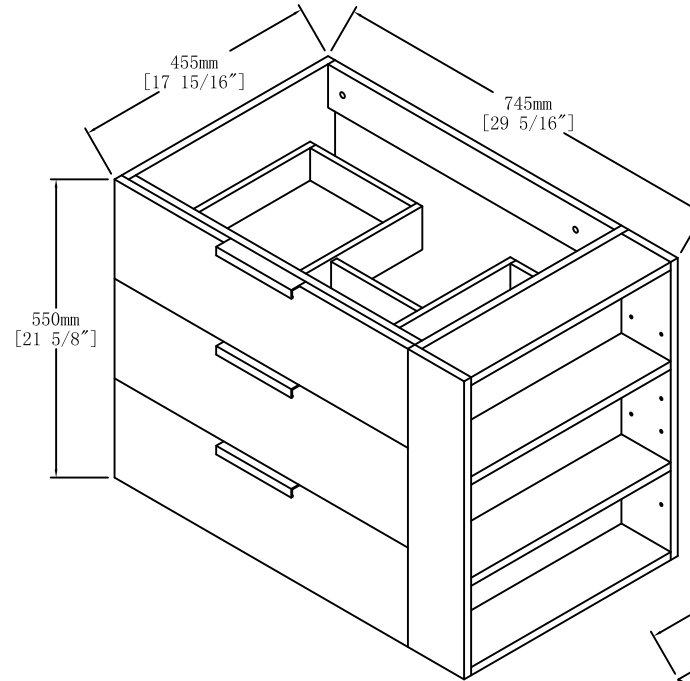
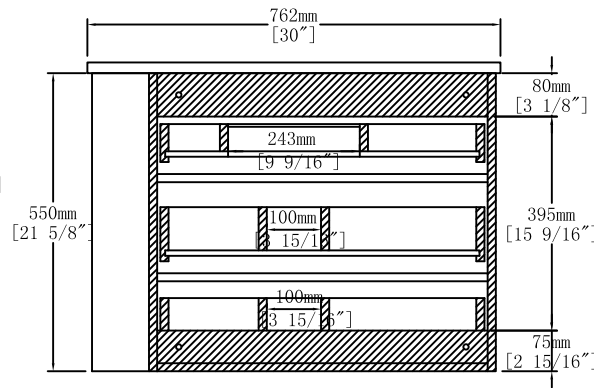

Back View



Item NO.

BV B01430

Version

V1

Projece

Date

2022-6-22