

Top View

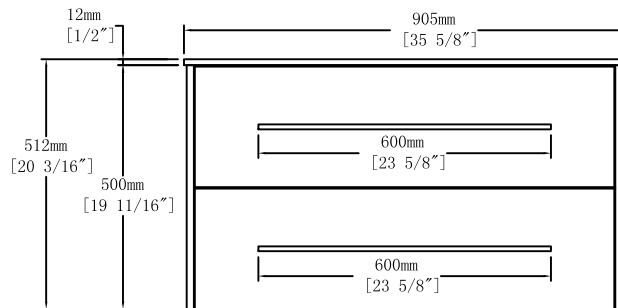

Front View

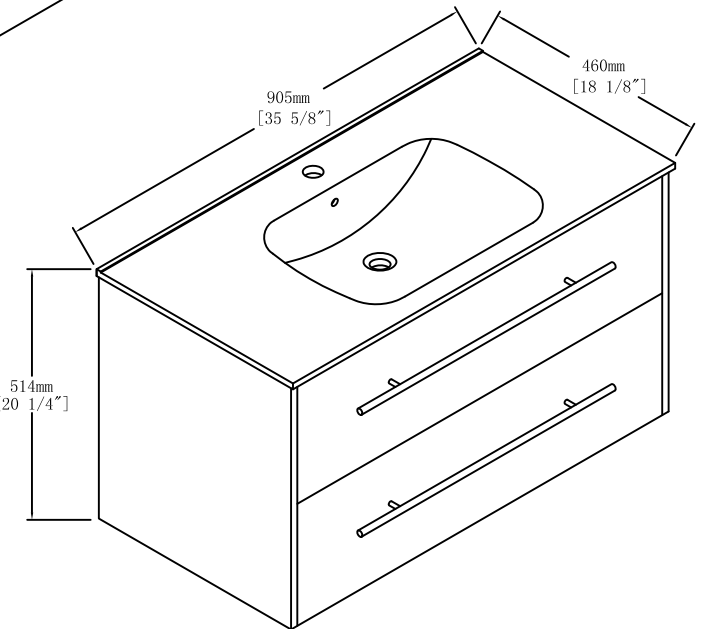
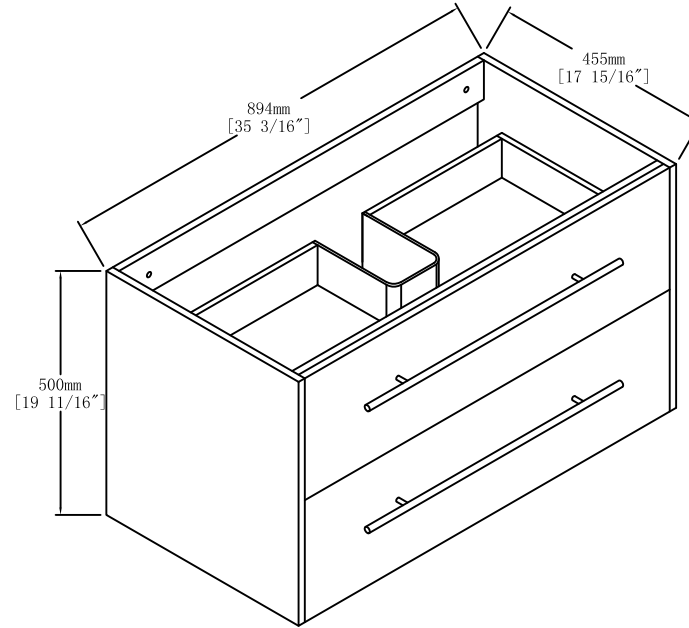
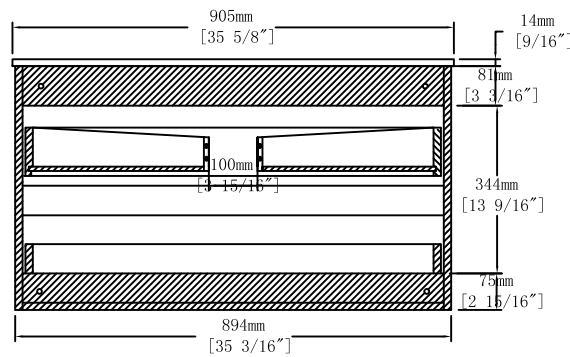

Back View



Item NO.

BV C04936

Version

V1

Projece

Date

2022-12-20