

Top View

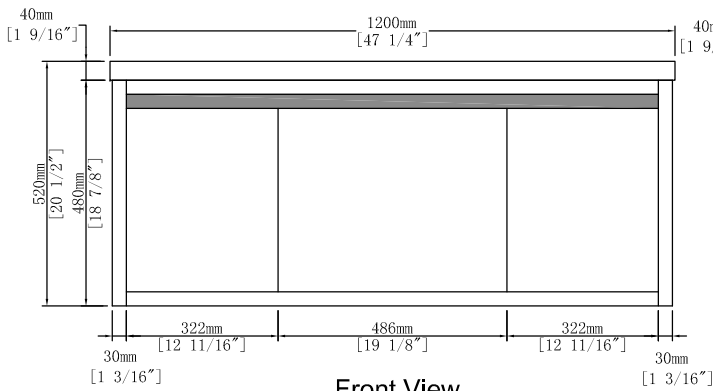

Front View

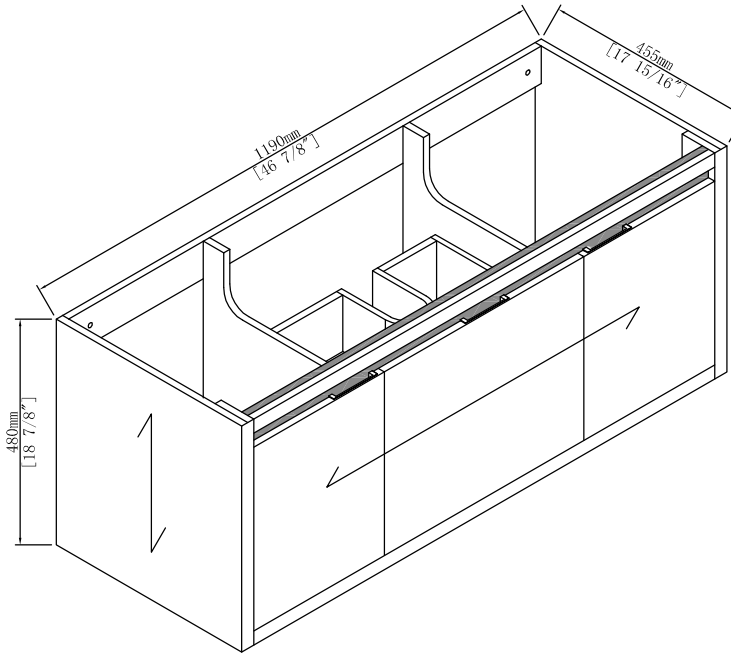
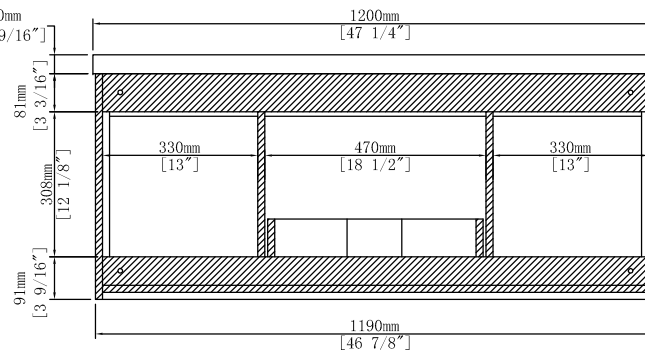

Back View

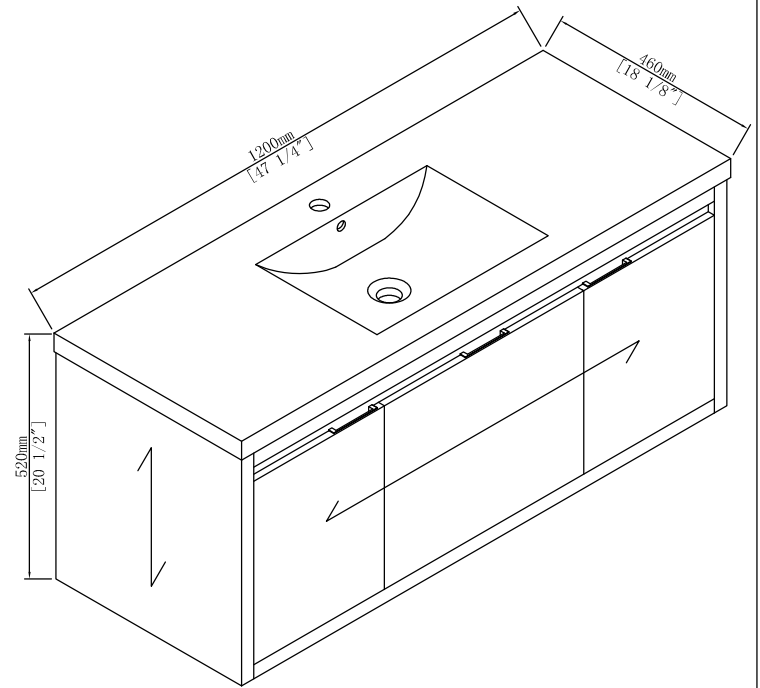

Item NO. **BV C00948**

Version

Project

Date

2022. 3. 18