

Top View

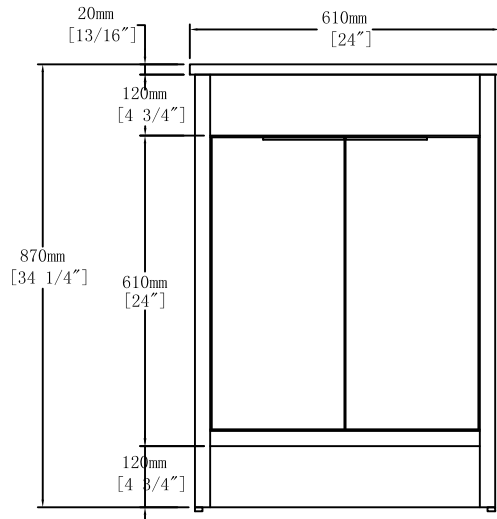

Front View

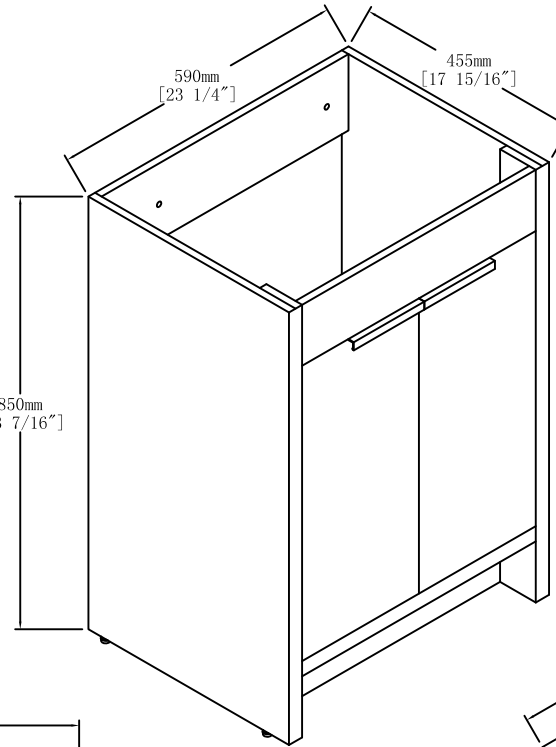
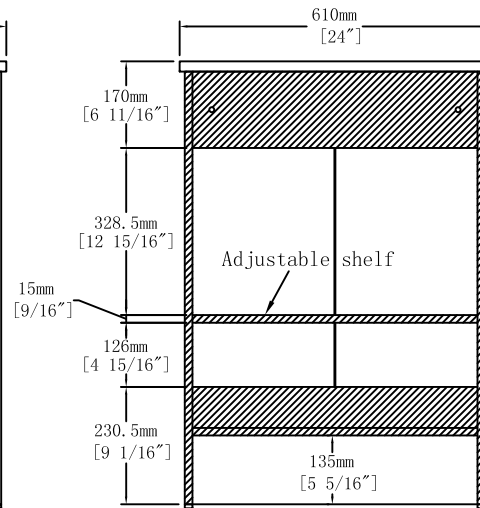

Back View

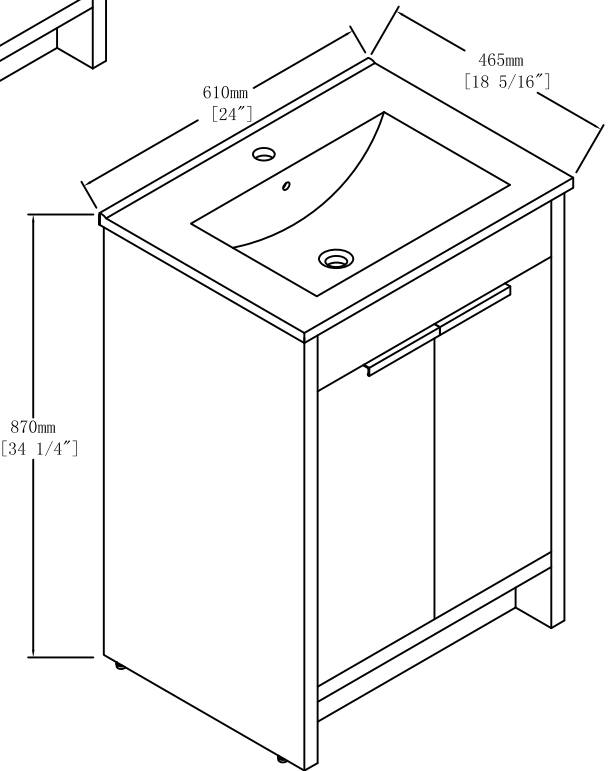

Item NO.

BV B02424

Version

V1

Projece

Date

2022-8-9