

Top View

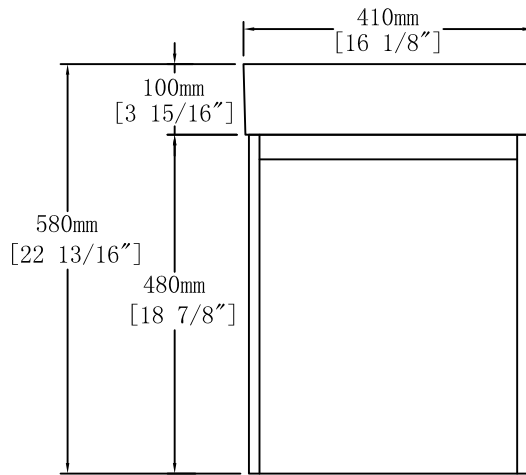

Front View

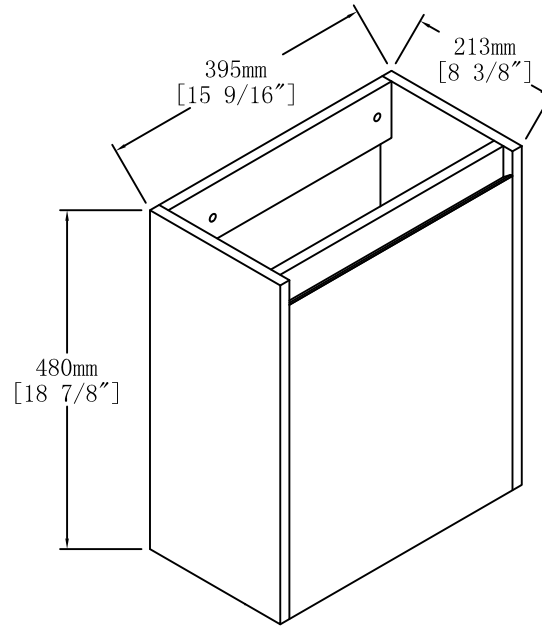
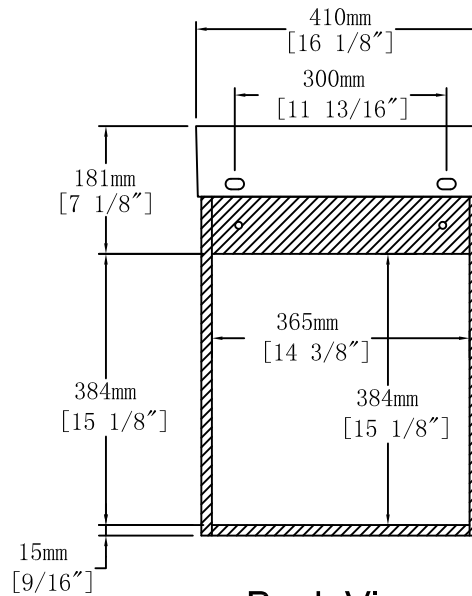

Back View

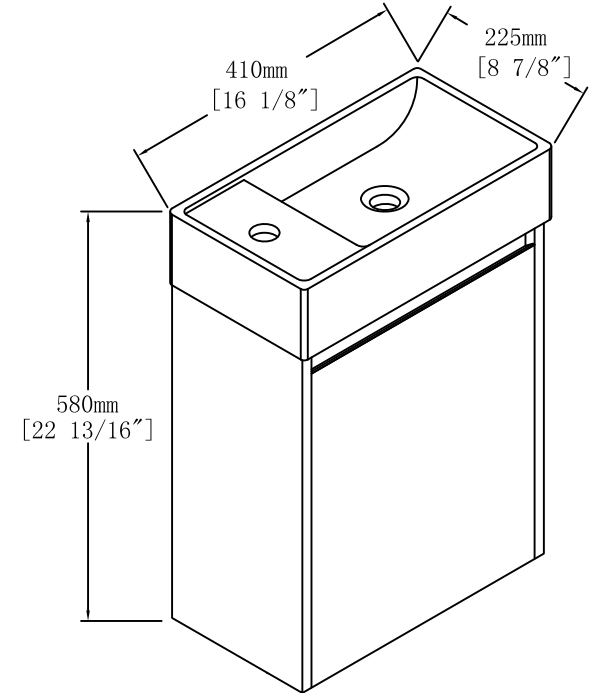

Item NO. BV C03318

Version V1

Projece

Date 2022-10-29