

Top View

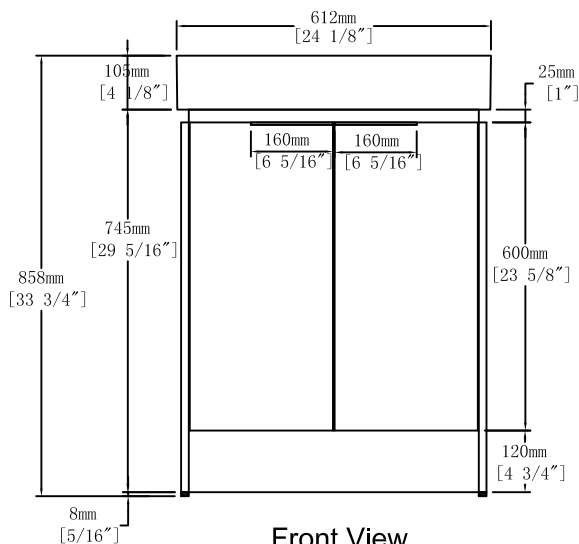

Front View

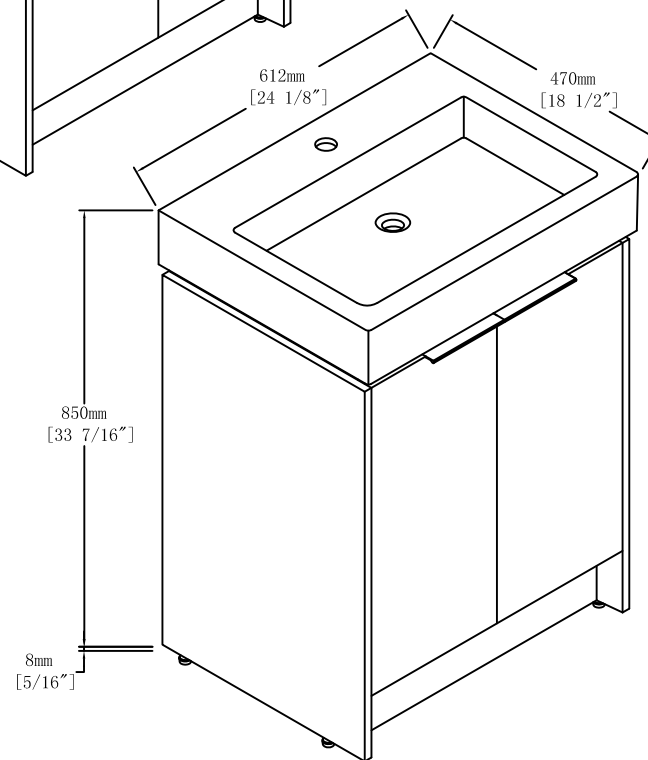
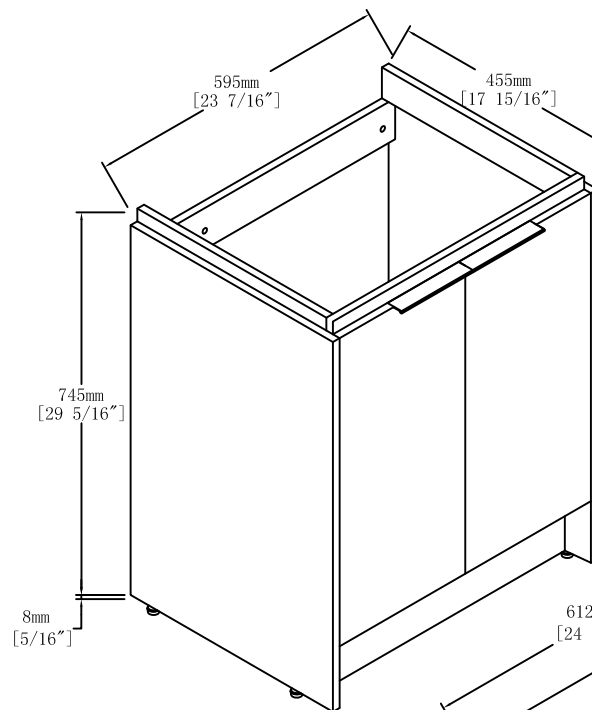
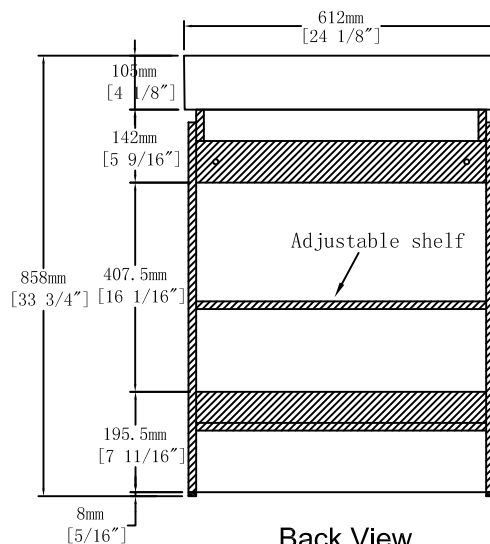

Back View



Item NO.

BV C03824

Version

V1

Projece

Date

2022-11-25