

THANKS FOR WATCHING

Your feedback is invaluable to us and we would love to hear about your experience. Please take the time to leave us a review.

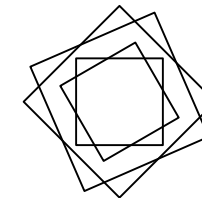

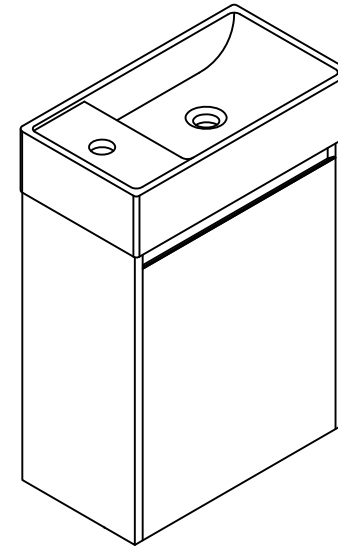



Thank you for shopping with us!

We encourage you to take a few minutes to go through this booklet. It contains important information on installation and care tips to keep your furniture looking as good as new.

Item NO.:BV C03318

Hardware

NO.	Draw	QTY
A		2
B		2
C		2
D		2

Recommended tools

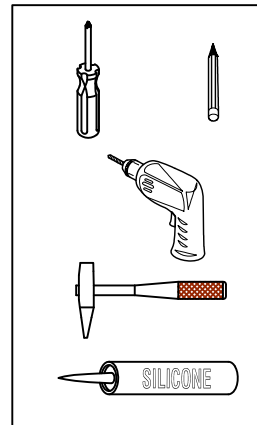

Dimensions

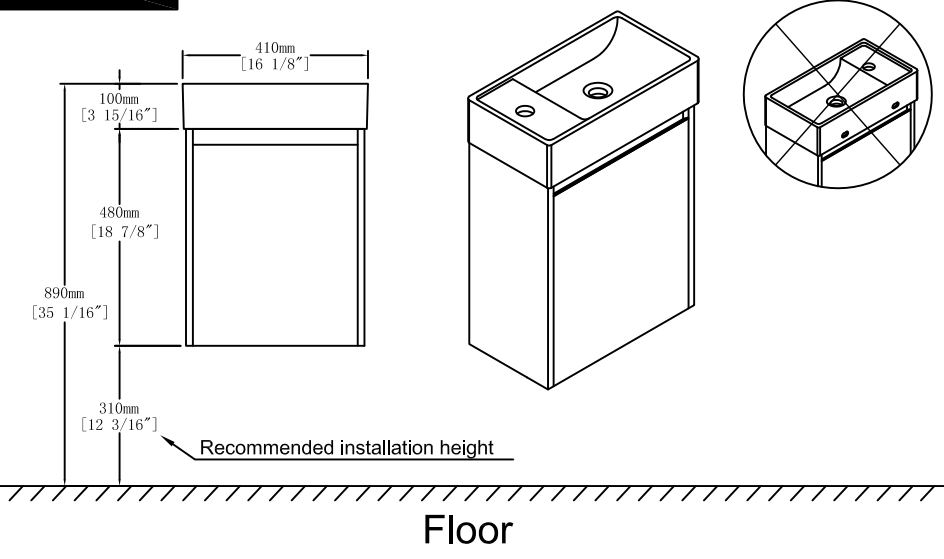

Dimensions

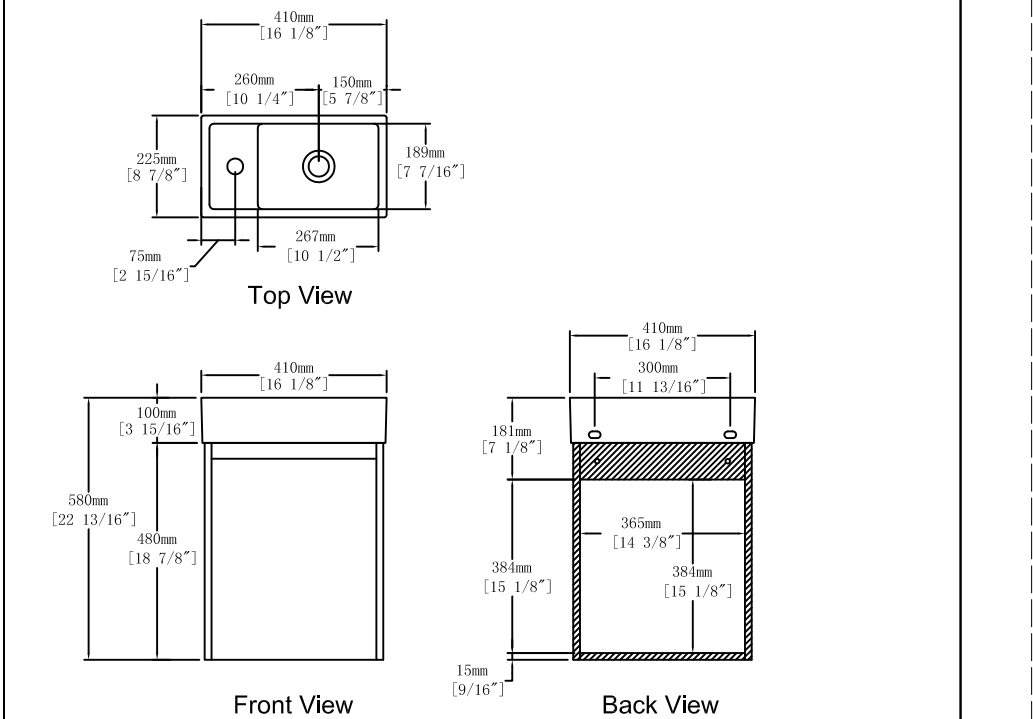

CARE CLEANING AND MAINTENANCE

1. Dust regularly with a soft , dry cloth.
2. Avoid the use of all chemicals household cleaners, abrasives, or cleaners that contain lemon, vinegar, or other acids that may damage the finish.
3. Excessive exposure to sunlight and extreme changes in temperature and moisture can damage wood furniture.
4. The sink top is resilient, but care needs to be taken to preserve its appearance.
5. Do not place hot appliances, such as curling irons and hot hair dryers directly on the countertop. Wipe spills immediately.

Coverage Distance

Rotate screw to the right: Coverage distance decrease (-)
Rotate screw to the left: Coverage distance increase (+)

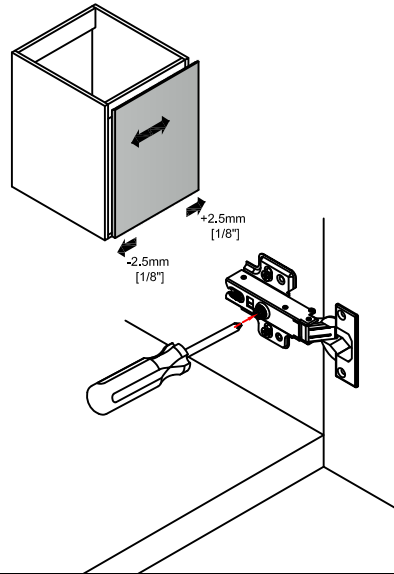

Depth Distance

Release the screw, adjust the distance between the door & vanity and tighten the fastening screw.

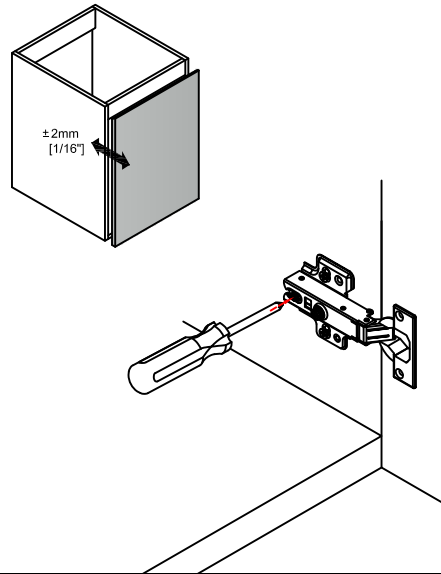

Height Distance

Release the base screw, adjust the height of the door, and then tighten the screw.

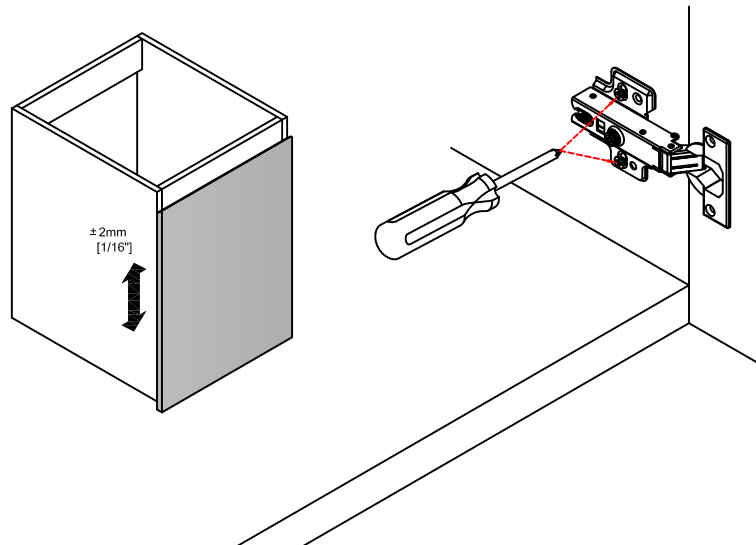

Step 1

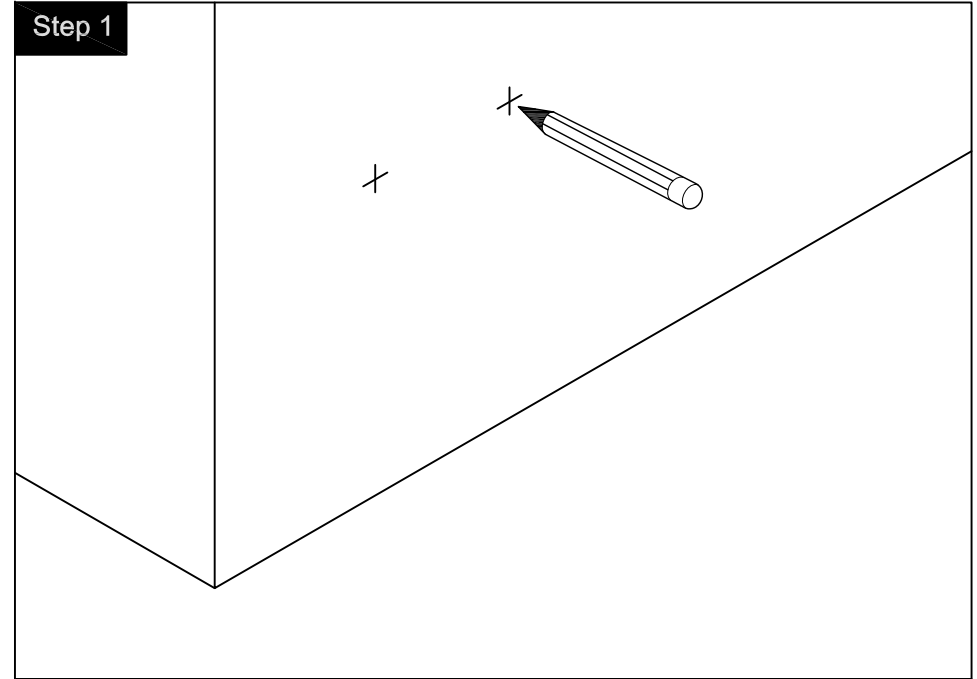

Step 2

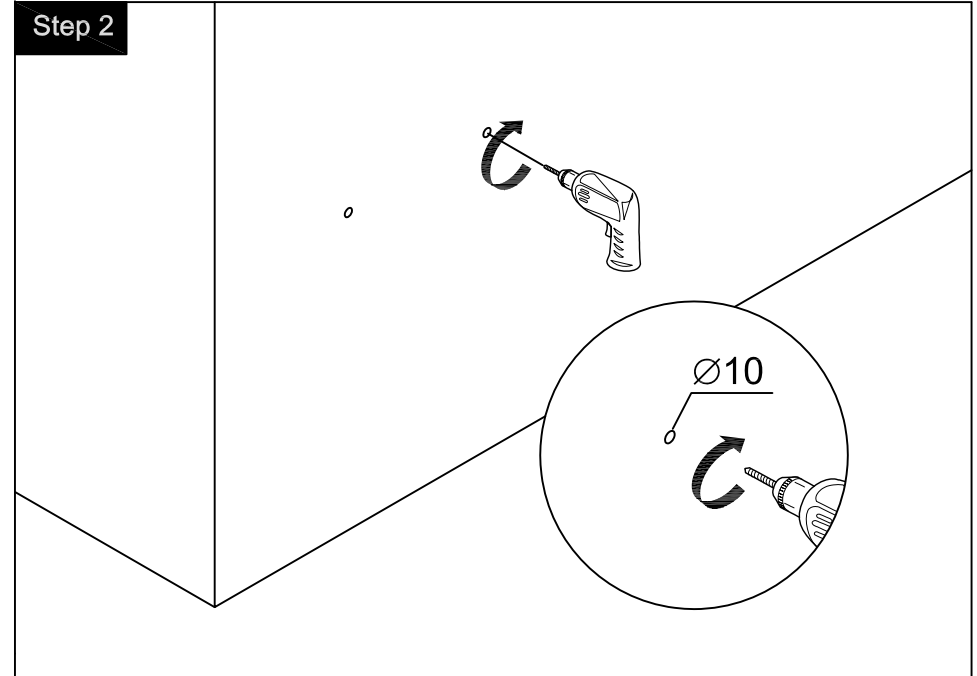

Step 3

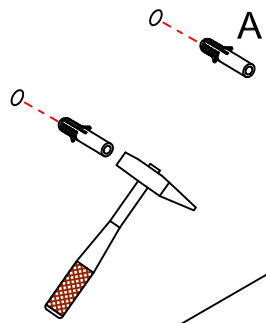

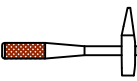

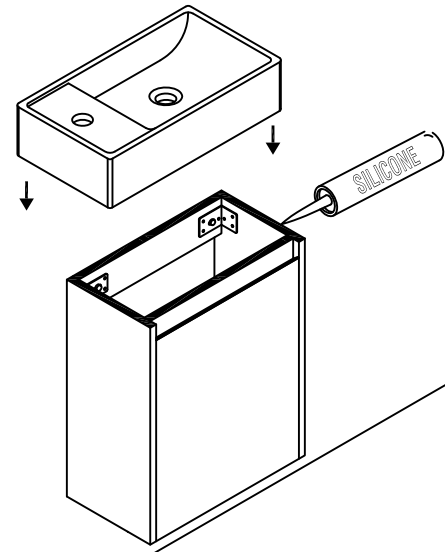

-  x2
- A
- 
- Tool

Step 5

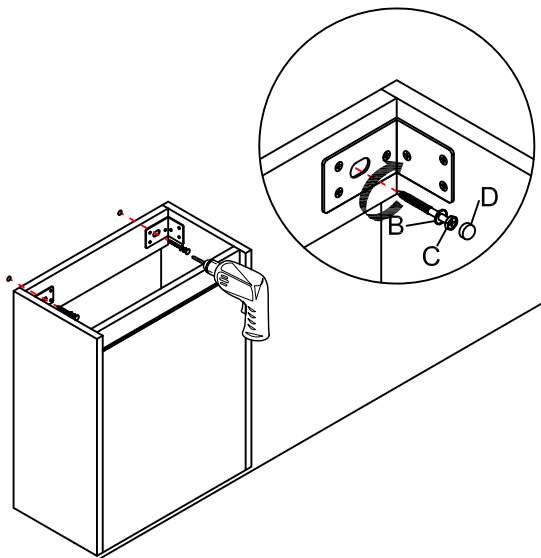

Step 4



-  x2
- B
-  x2
- C
-  x2
- D
- 
- Tool

Finished

