

Top View

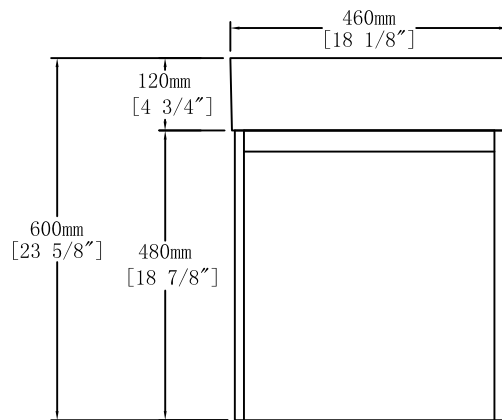

Front View

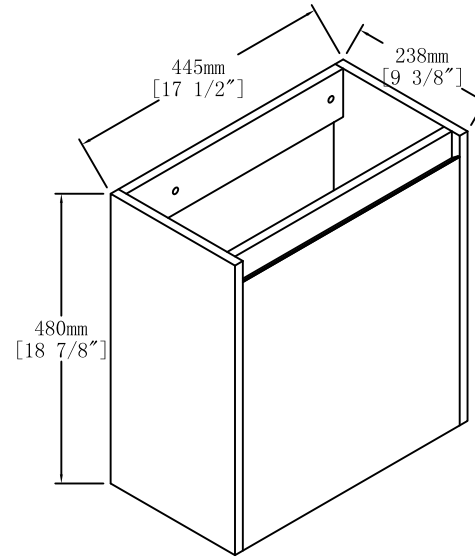
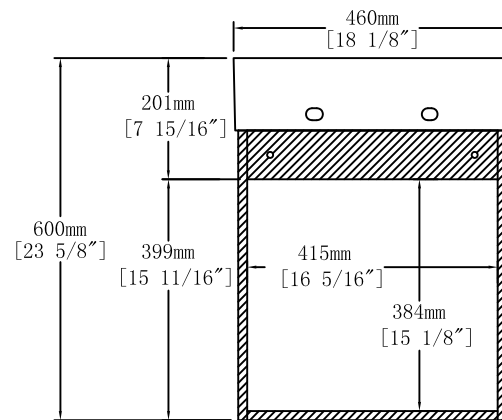

Back View

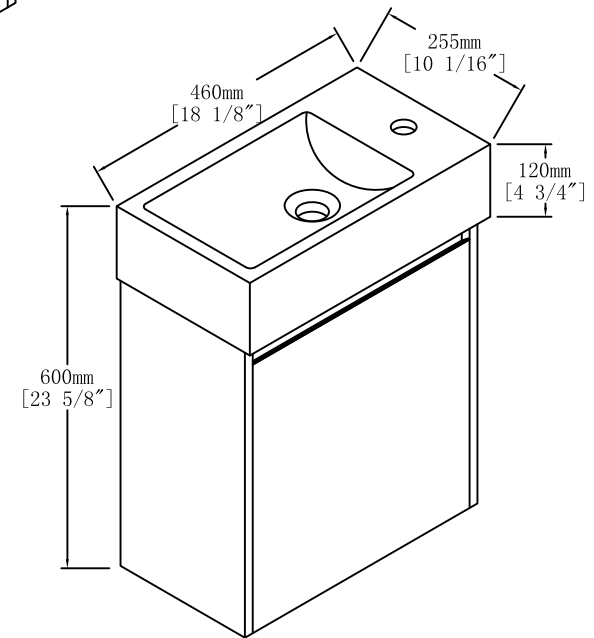

Item NO.

BV C03018

Version

V1

Projece

Date

2022-11-1