

Top View

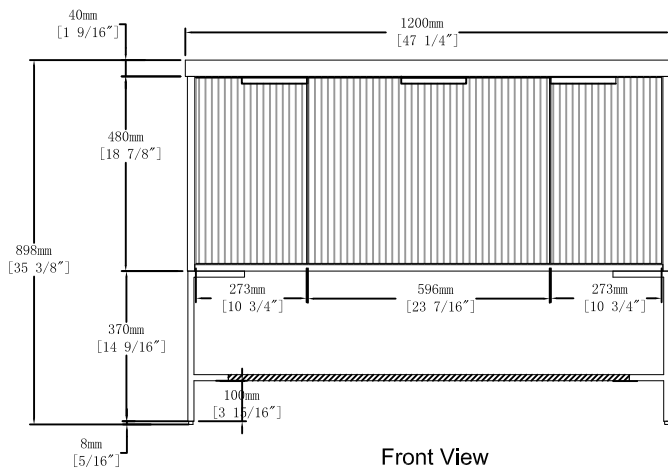

Front View

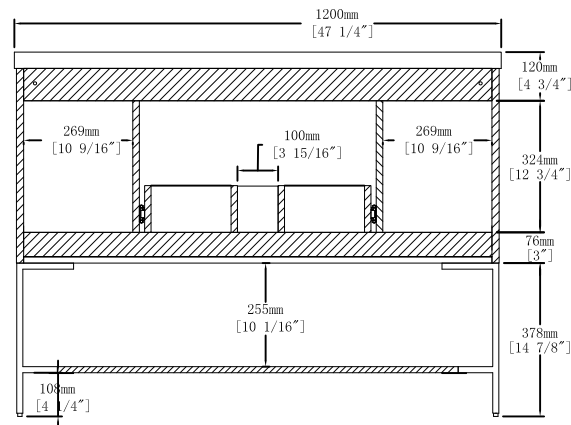

Back View

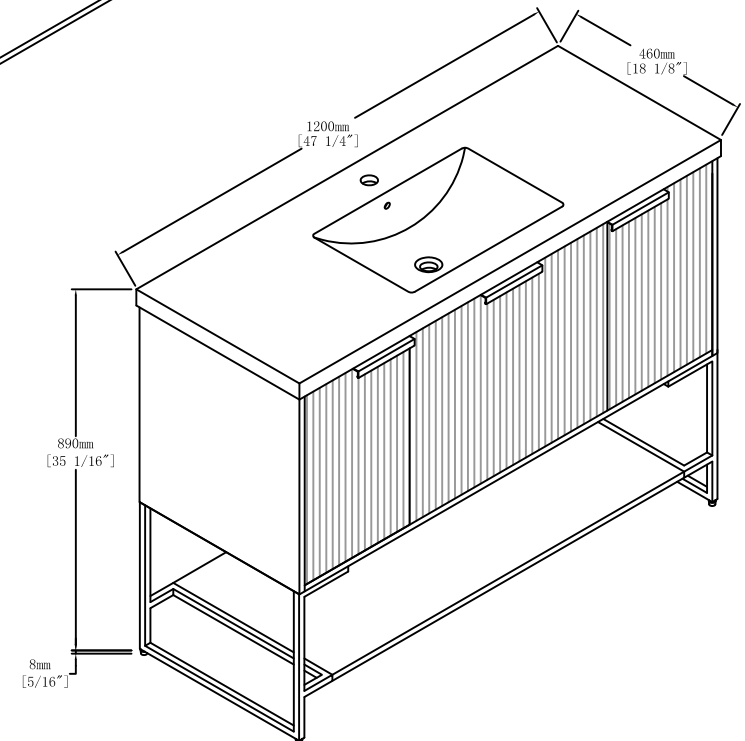

Item NO.

BV A01148

Version

V1

Projece

Date

2022-6-20