

Top View

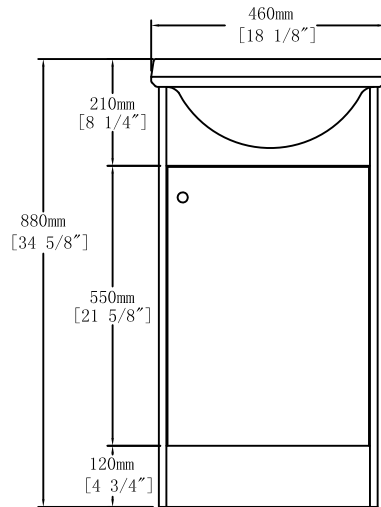

Front View

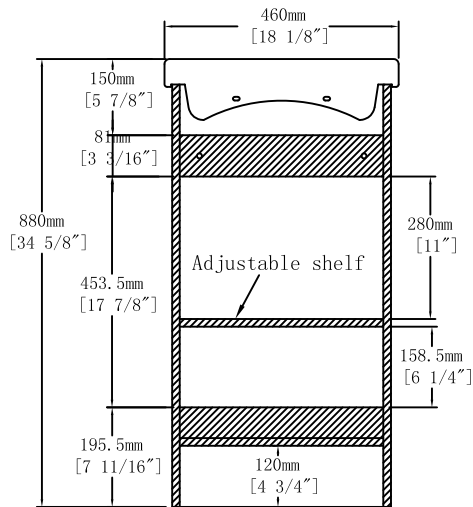

Back View

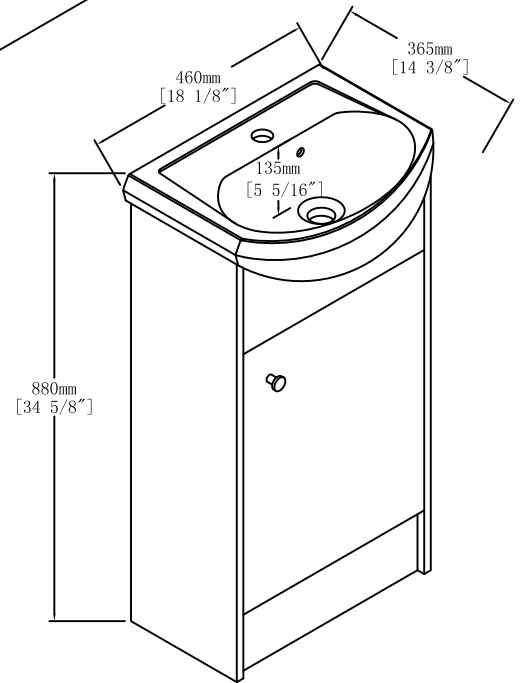
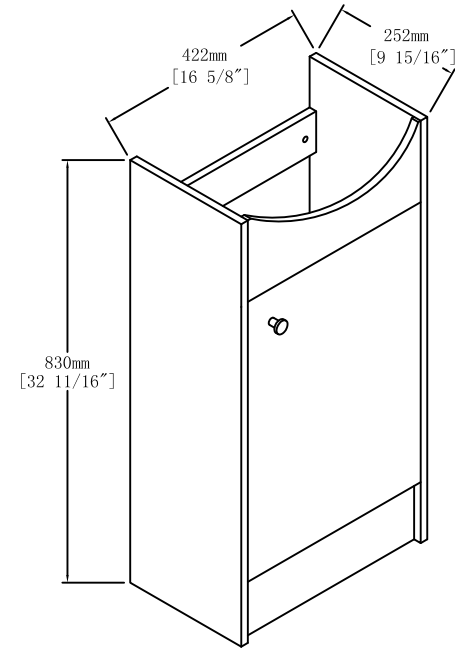

Item NO.

BV B02218

Version

V1

Projece

Date

2022-8-6