

Top View

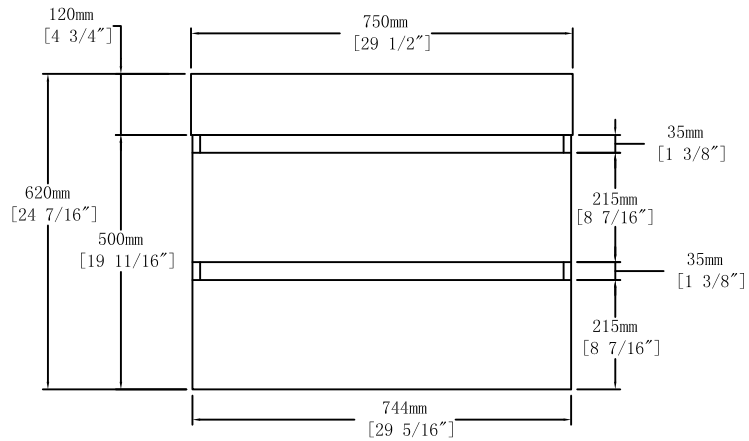

Front View

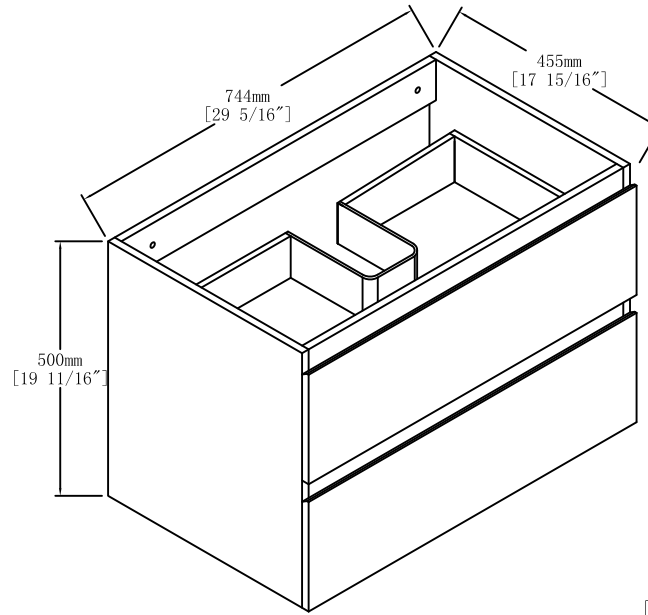
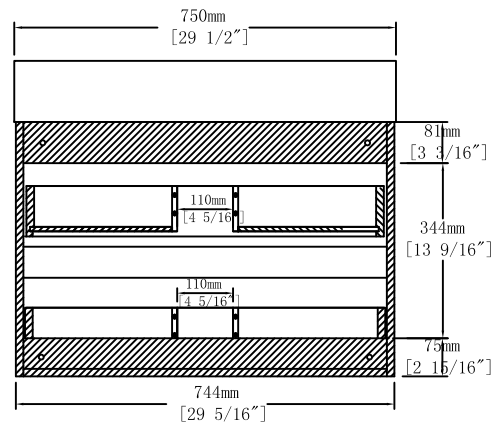

Back View

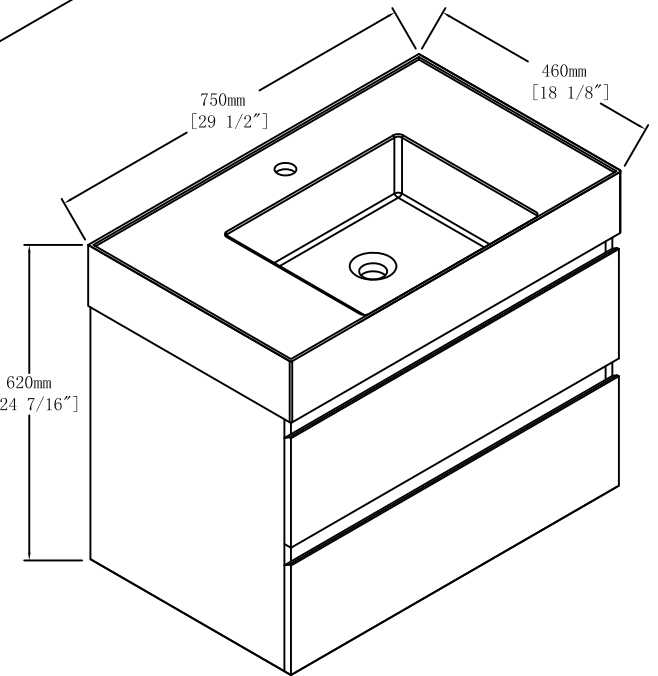

Item NO.

BV B01930-120

Version

V1

Project

Date

2024-5-27