

# ASSEMBLY INSTRUCTIONS

## 68" Fluted Glass Sideboard ITEM# GSI22X4

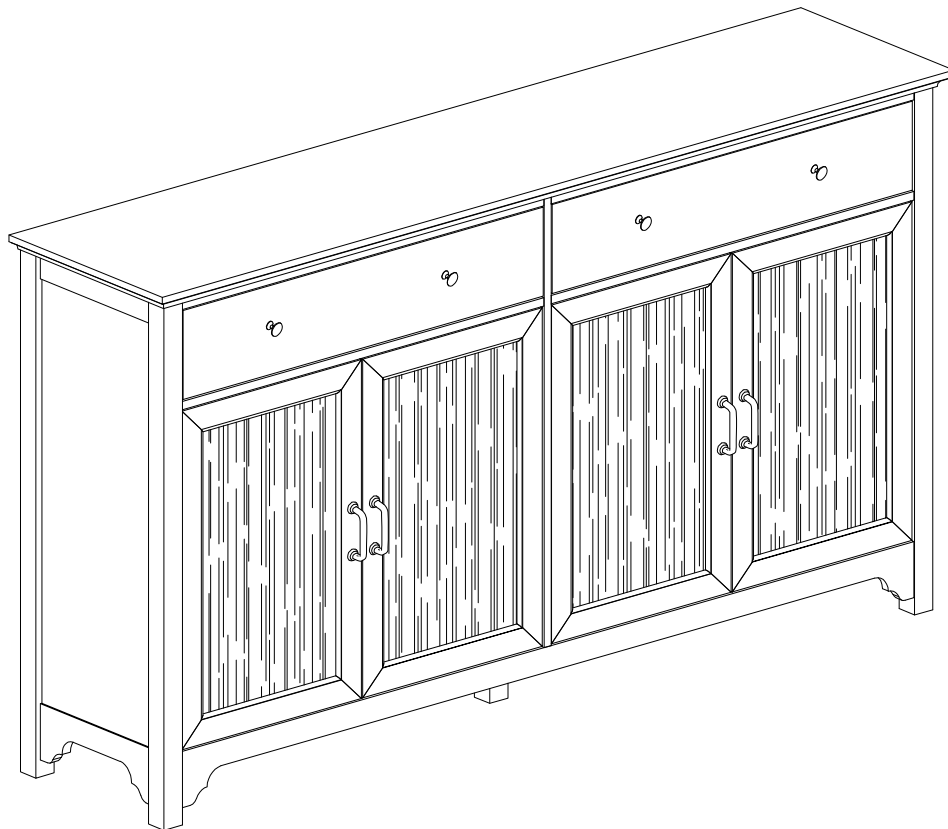

If you find any damage after opening, please be sure to take pictures of the damage and contact us. We will help you solve the problem as soon as possible.

*THANK YOU*

# General Assembly Guidelines

- I. Ensure that all parts and hardware are available before beginning assembly.
- II. Follow each step carefully to ensure the proper assembly of this product.
- III. Two people are recommended for ease in the assembly of this product.
- IV. The three main types of hardware used to assemble this product are : wood dowels , screws and bolts.
- V. A Phillips head screwdriver is required for the assembly of this product .

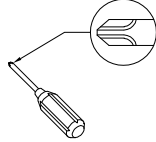

- VI. Power tools should not be used to assemble this product .

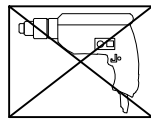

- VII. The provided glue is to secure wood dowels in place. When first inserting dowels, locate the appropriate hole for the dowel, place a small amount of glue in the hole and insert the dowel. Wipe away excess glue immediately.

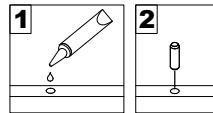

In future assembly steps when dowels are necessary to attach assembly parts together, place a small amount of glue on the end of the dowel before attaching parts together. Wipe away excess glue immediately.

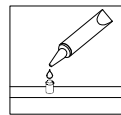

- VIII. Concealed hinges are three-way adjustable.

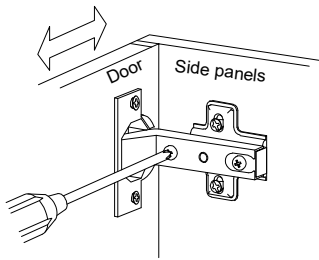

Horizontal  
by screw adjustment

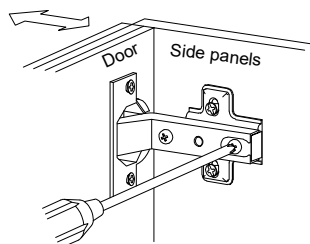

In-and-Out  
by loosening the hinge-arm  
mounting screw or via cam  
adjustment

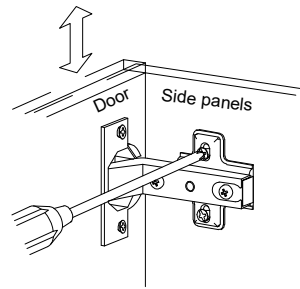

Vertical  
Via slots in the mounting  
plate or via cam adjustment

- VIII. Assemble the furniture on empty carton, carpet, or rug to prevent scratches or damage.

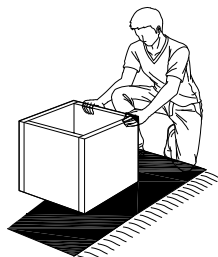





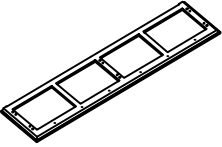
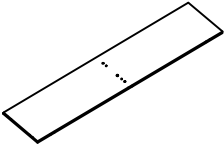
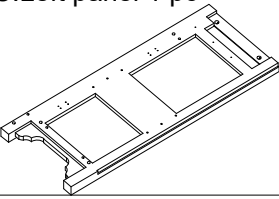
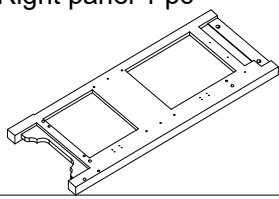
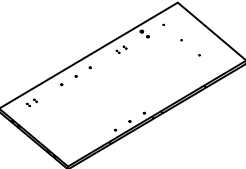
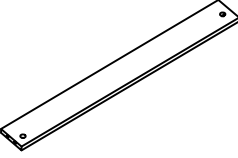
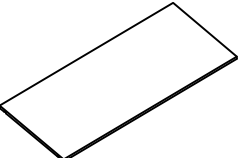
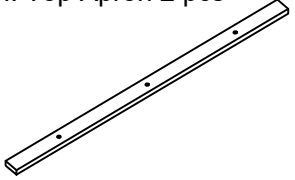
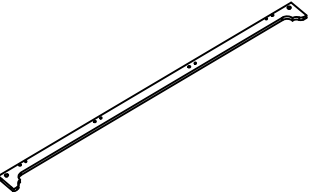
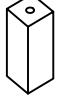
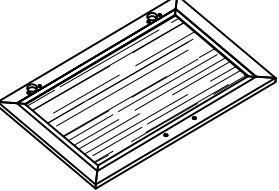
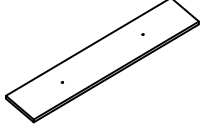
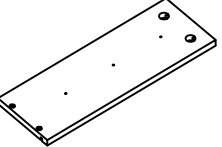
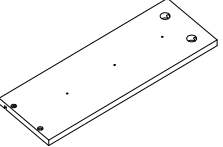
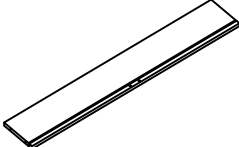
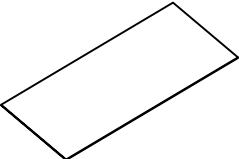
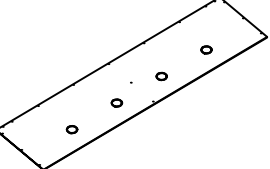
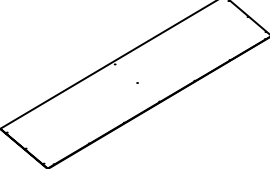
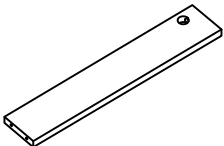
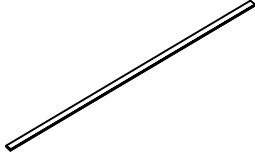







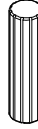

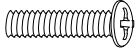
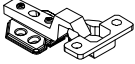



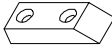

# PARTS LIST

## A Carton part list

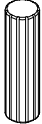

<p>A:Top panel 1 pc</p> 	<p>B:Bottom panel 1 pc</p> 	<p>C:Left panel 1 pc</p> 	<p>D:Right panel 1 pc</p> 
<p>E: Partition Panel 1 pc</p> 	<p>F: Front Stretcher 2 pcs</p> 	<p>G: Shelf 2 pcs</p> 	<p>H: Top Apron 2 pcs</p> 
<p>I: Bottom Front Apron 1 pc</p> 	<p>J: Support Leg 1 pc</p> 	<p>K:Door 4 pcs</p> 	<p>L: Drawer Front Panel 2 pcs</p> 
<p>M: Drawer Left Panel 2 pcs</p> 	<p>N:Drawer Right Panel 2 pcs</p> 	<p>O:Drawer Back panel 2 pcs</p> 	<p>P:Drawer Bottom panel 2pcs</p> 
<p>Q:Top Back panel 1 pc</p> 	<p>R:Bottom Back panel 1 pc</p> 	<p>S:Drawer Bottom Rail 2pcs</p> 	<p>T: Plastic Tube 1 pc</p> 

# PARTS LIST

## HARDWARE LIST

<p>1:Cam lock 32 pcs</p>  <p style="text-align: center;">Ø15x10</p>	<p>2:Cam bolt 22 pcs</p>  <p style="text-align: center;">Ø6x32</p>	<p>3:Wood plug 26 pcs</p>  <p style="text-align: center;">Ø8x30</p>	<p>4:Pull knob 4 pcs</p> 
<p>5:Screw 12 pcs</p>  <p style="text-align: center;">Ø4x18</p>	<p>6.Hinge 8pcs</p>  <p style="text-align: center;">Ø26</p>	<p>7:Screw 48 pcs</p>  <p style="text-align: center;">Ø3.5 X 16</p>	<p>8:Wood screw 30 pcs</p>  <p style="text-align: center;">Ø3.0x12</p>
<p>9.Shelf support pin 8 pcs</p>  <p style="text-align: center;">Ø8x5x16</p>	<p>10: Door stopper 2pc</p> 	<p>11: Screw 4pc</p>  <p style="text-align: center;">Ø3x14</p>	<p>12.Screw 18 pcs</p>  <p style="text-align: center;">Ø4x25</p>
<p>13:Cam bolt 10 pcs</p>  <p style="text-align: center;">Ø6x32</p>	<p>14.Bolt &amp; Hex key 1 pcs</p>  <p style="text-align: center;">M6x30      M4</p>	<p>15:Handle 4 pcs</p> 	<p>16:Screw 2 pcs</p>  <p style="text-align: center;">Ø3x15</p>
<p>17:Plastic strap 2 pcs</p> 	<p>18:Nut 2 pcs</p> 	<p>19:Screw 2 pcs</p>  <p style="text-align: center;">Ø4x25</p>	<p>20.Sticker 32 pcs</p> 
<p>21:Wood plug 2 pcs</p>  <p style="text-align: center;">Ø6x30</p>	<p>22.:Glue tube 2 pcs</p> 		

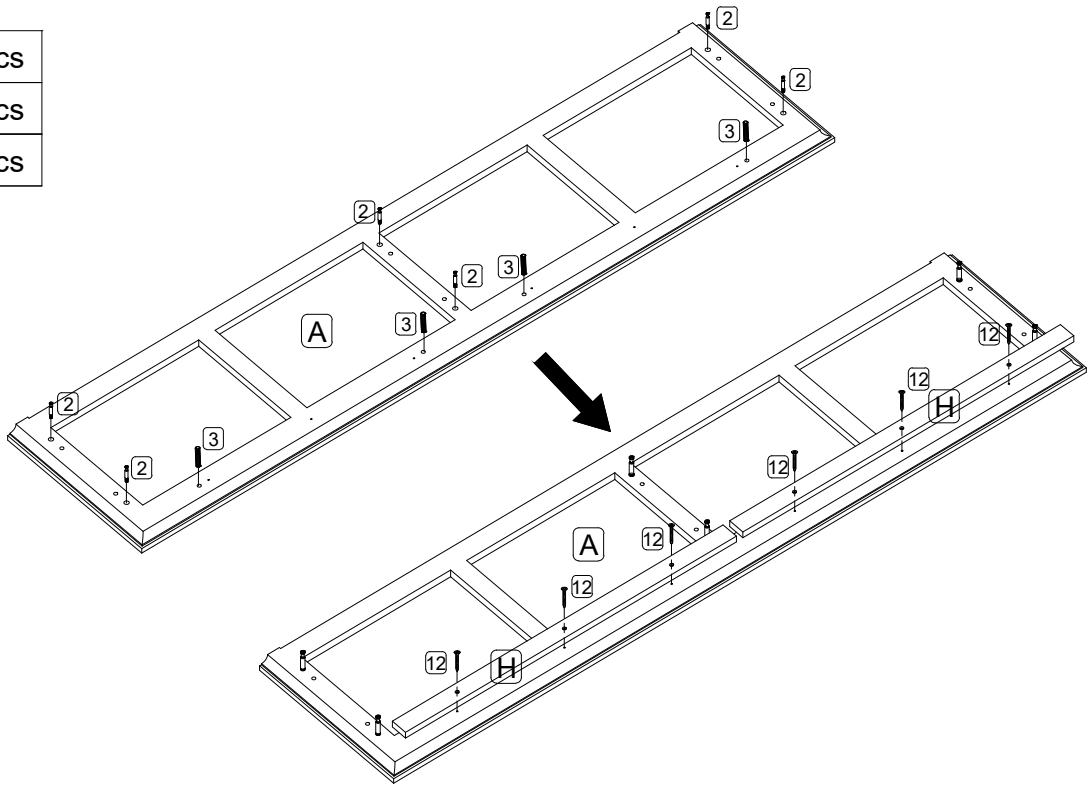

## Step 1

- |     |   |       |
|-----|---|-------|
| 2:  |  | 6 pcs |
| 12: |  | 6 pcs |
| 3:  |  | 4 pcs |



Secure cam bolt (2) into part (A) with Philips head screwdriver as per diagram, then attach part (H) to part (A) by using screw (12) with Philips head screwdriver as per diagram.

## Step 2

- |    |   |       |
|----|---|-------|
| 2: |  | 8 pcs |
| 3: |  | 4 pcs |

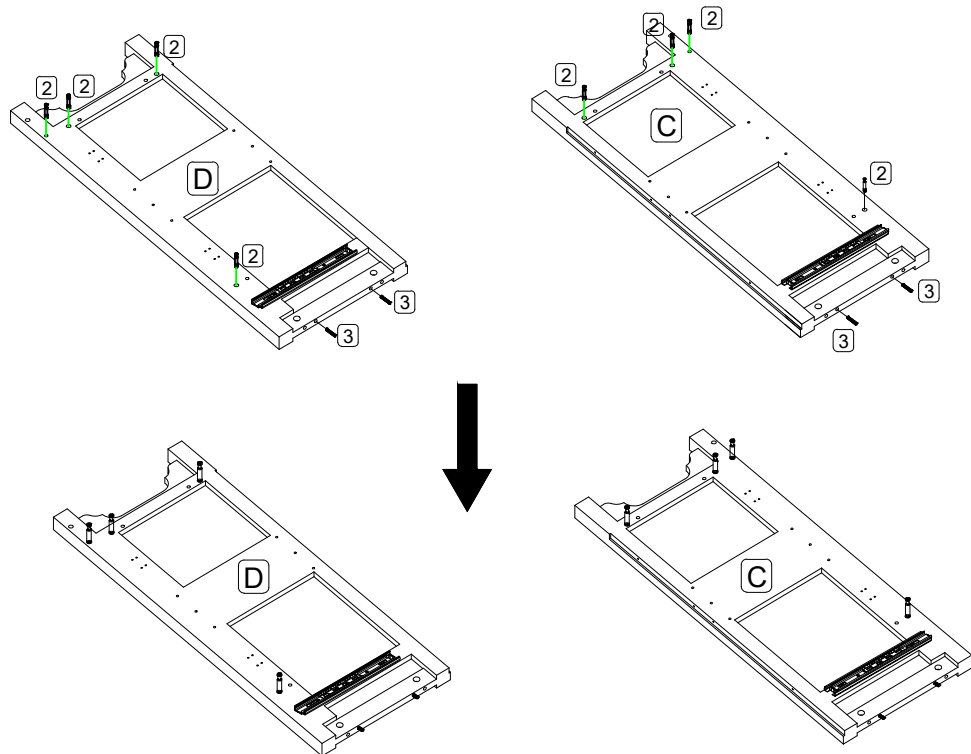

Secure cam bolt (2) into part (C,D) with Philips head screwdriver as per diagram, and insert wooden dowels (3) into part (C,D) as per diagram.

### Step 3

2:  2 pcs

3:  4 pcs

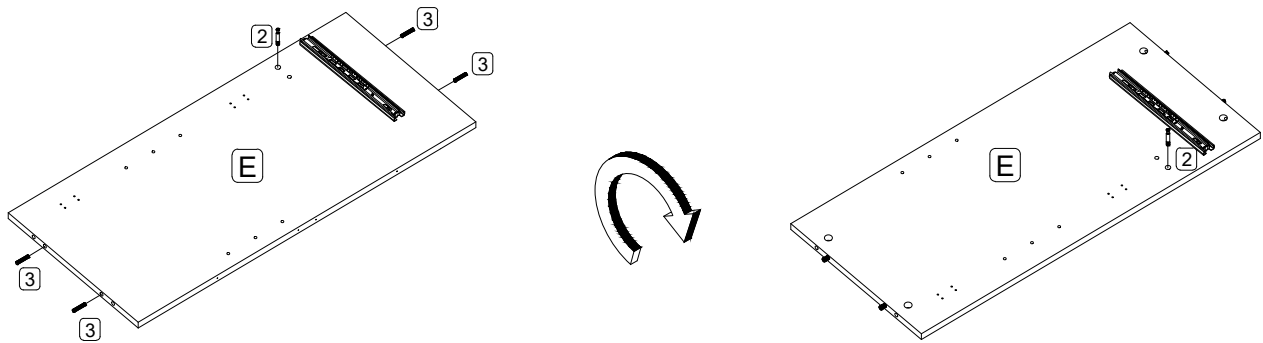

Secure cam bolt (2) into part (E) with Philips head screwdriver, and then turn panel (E) over. Insert wooden dowels (3) into part (E) as per diagram.

### Step 4

2:  4 pcs

3:  6 pcs



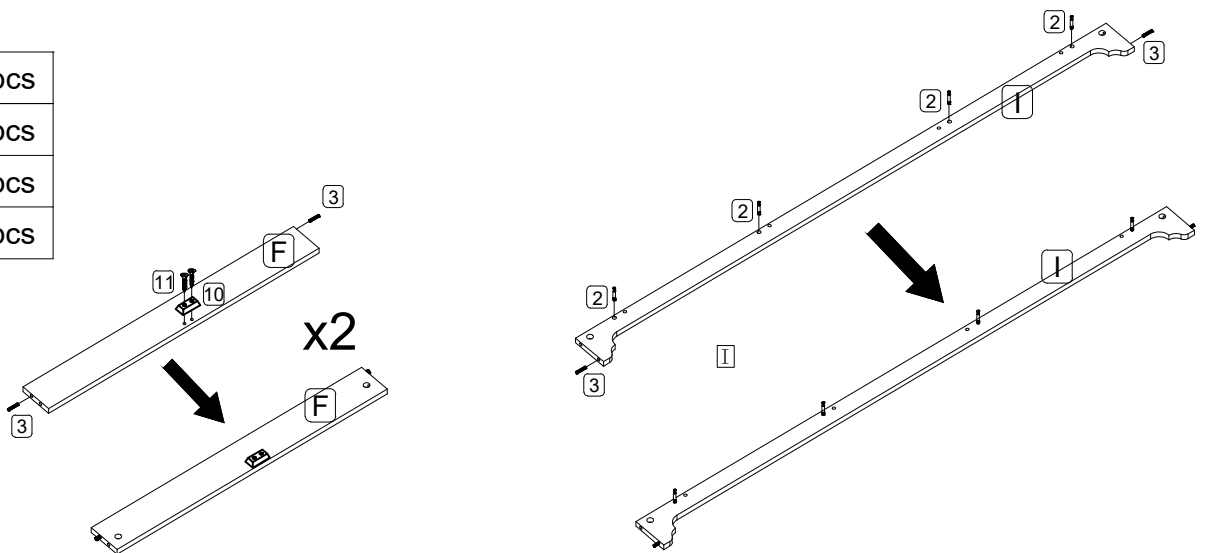

10:  2 pcs

11:  4 pcs



Insert wooden dowels (3) into part (I,F). Using screw (11) secure the door stopper (10) to parts (F) as per diagram. Secure cam bolt (2) into part (I) with Philips head screwdriver as per diagram.

## Step 5

2:		2 pcs
3:		8 pcs
14:		1 pcs
		

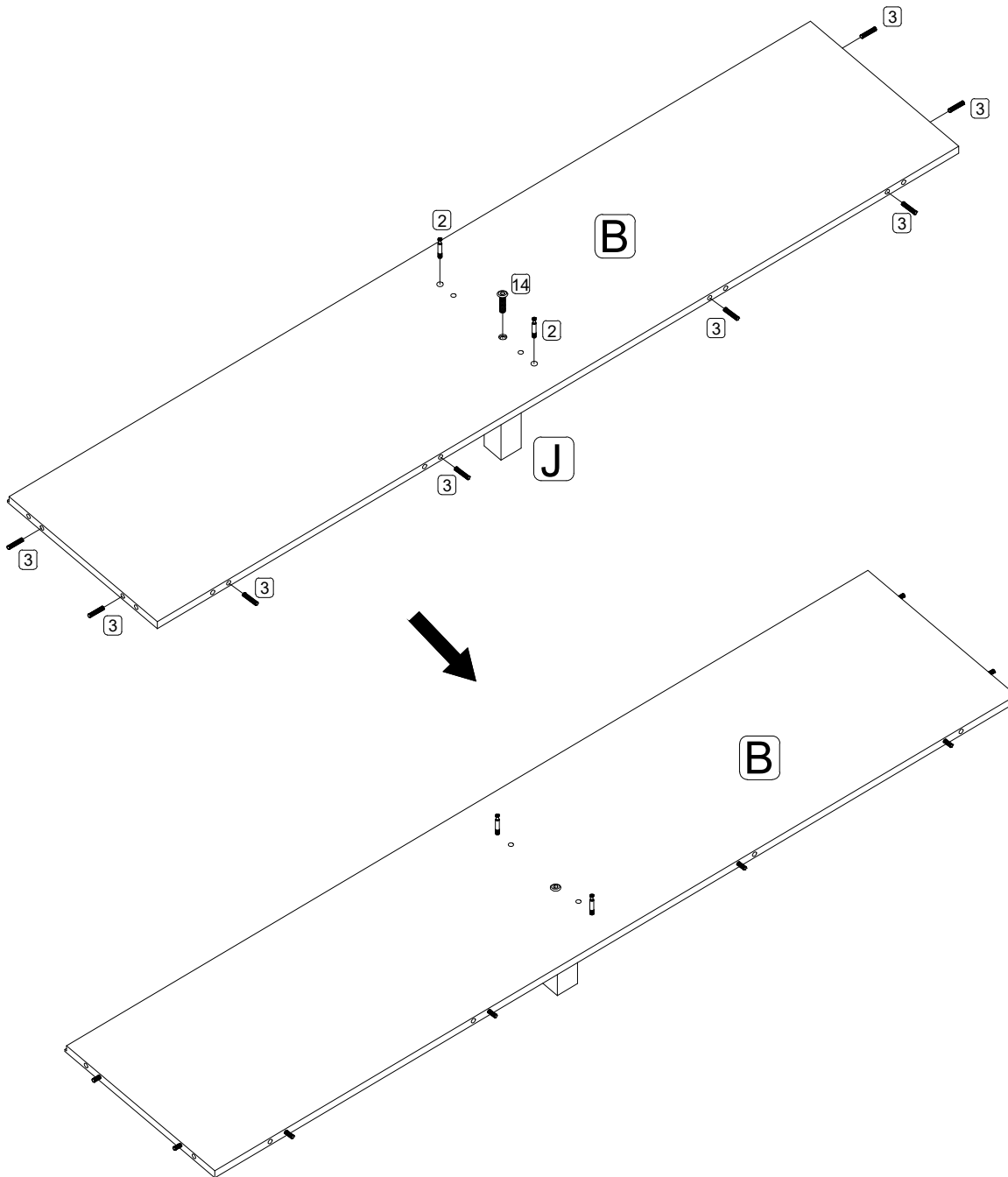

Insert wooden dowels (3) into part (B) and secure cam bolt (2) into part (B) with Philips head screwdriver as per diagram.

Attach part (J) to part (B) by using screw (14).

## Step 6

1:  4 pcs

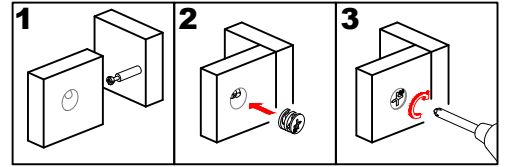

*Note: Please don't over-tighten the cam lock, otherwise, it will be broken.*

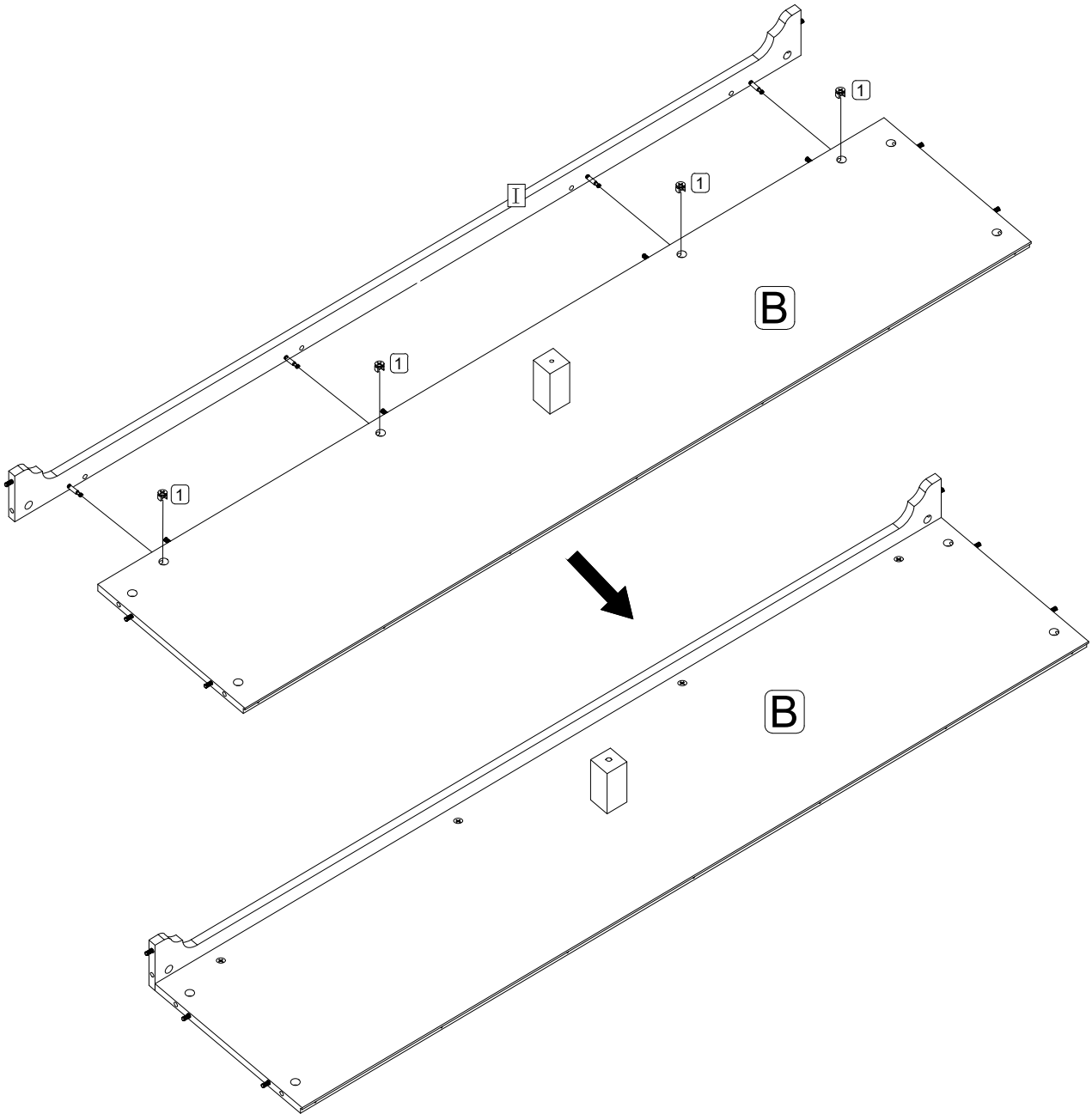

Use cam lock (1) secure parts (I) to part (B) with Philips head screwdriver as per diagram.



## Step7

1:  2 pcs

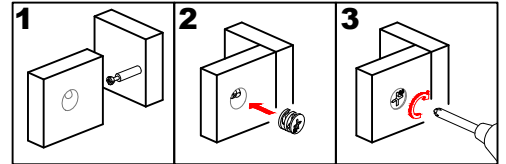

*Note: Please don't over-tighten the cam lock, otherwise, it will be broken.*

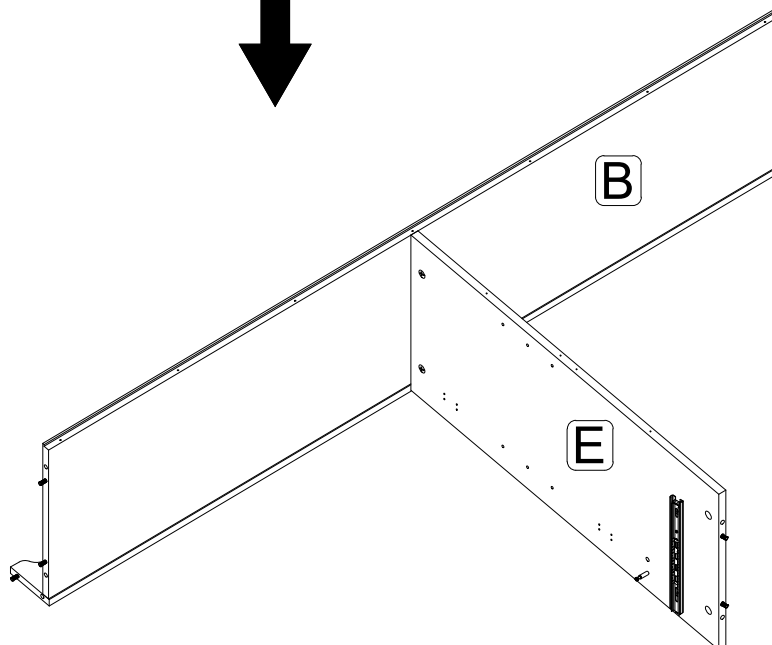
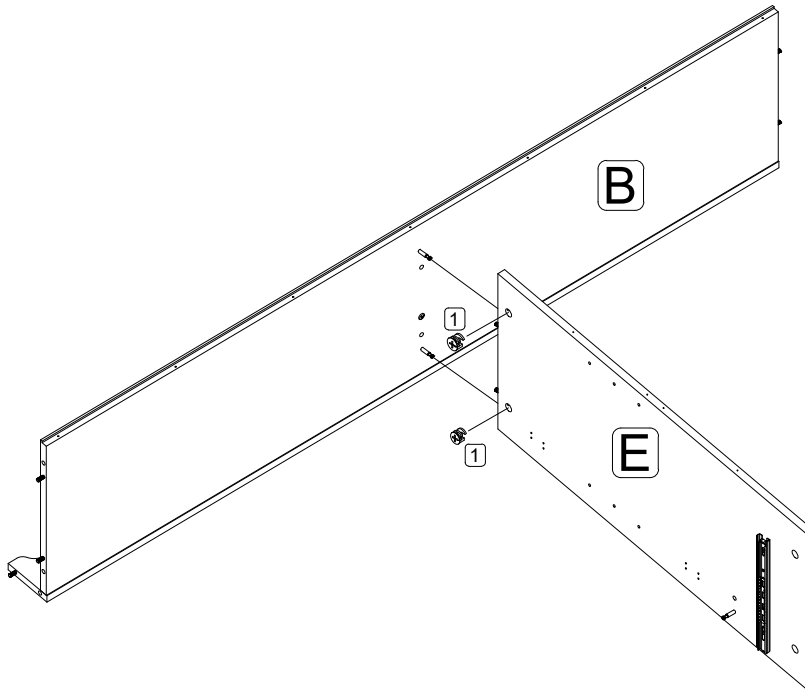

Using cam lock (1) secure parts (E) to part (B) with Philips head screwdriver as per diagram.

## Step 8

1:  2 pcs

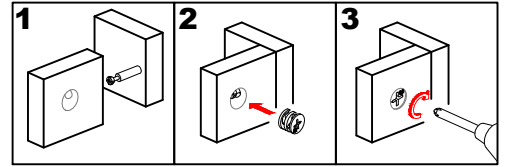

*Note: Please don't over-tighten the cam lock, otherwise, it will be broken.*

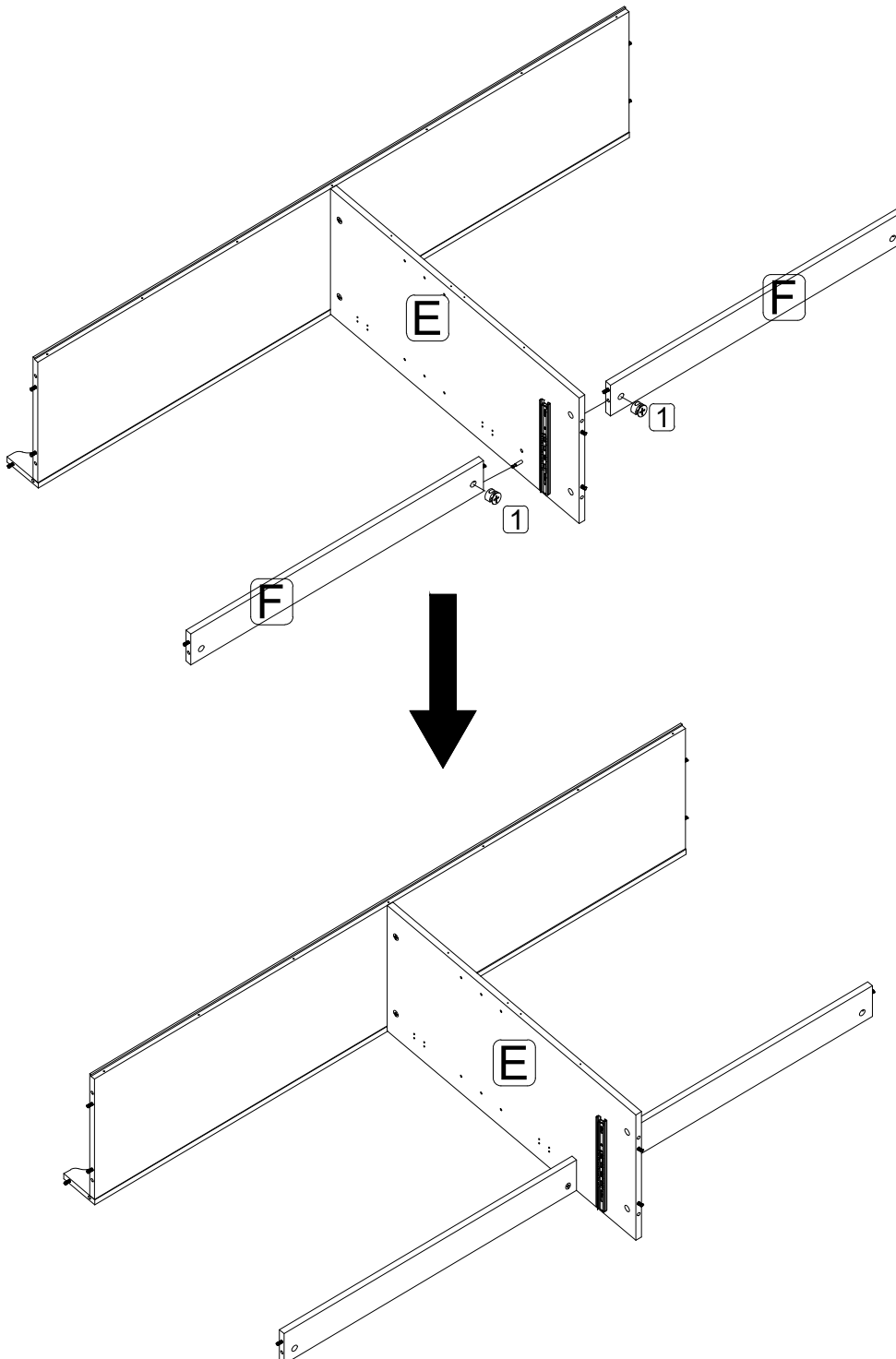

Use cam lock (1) secure parts (F) to part (E) with Philips head screwdriver as per diagram.

## Step 9

1:  8 pcs

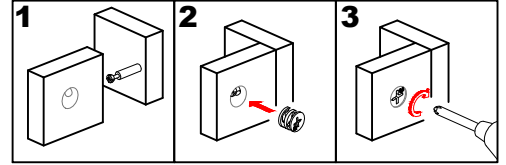

*Note: Please don't over-tighten the cam lock, otherwise, it will be broken.*

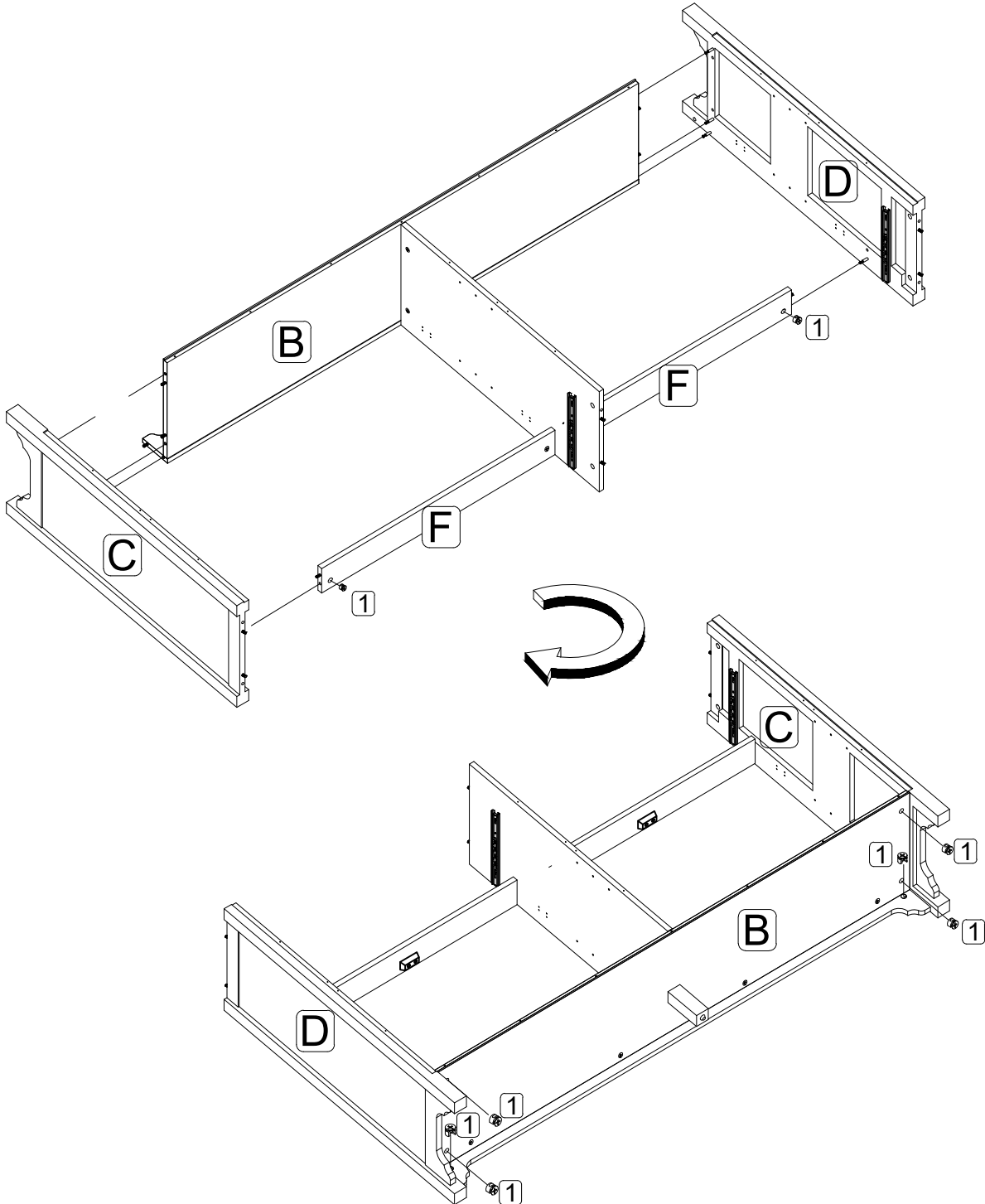

Use cam lock (1) secure parts (C,D) to the assembly with Philips head screwdriver as per diagram.

## Step 10

1:  6 pcs

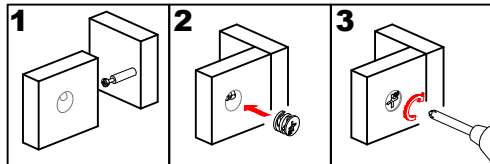

*Note: Please don't over-tighten the cam lock, otherwise, it will be broken.*

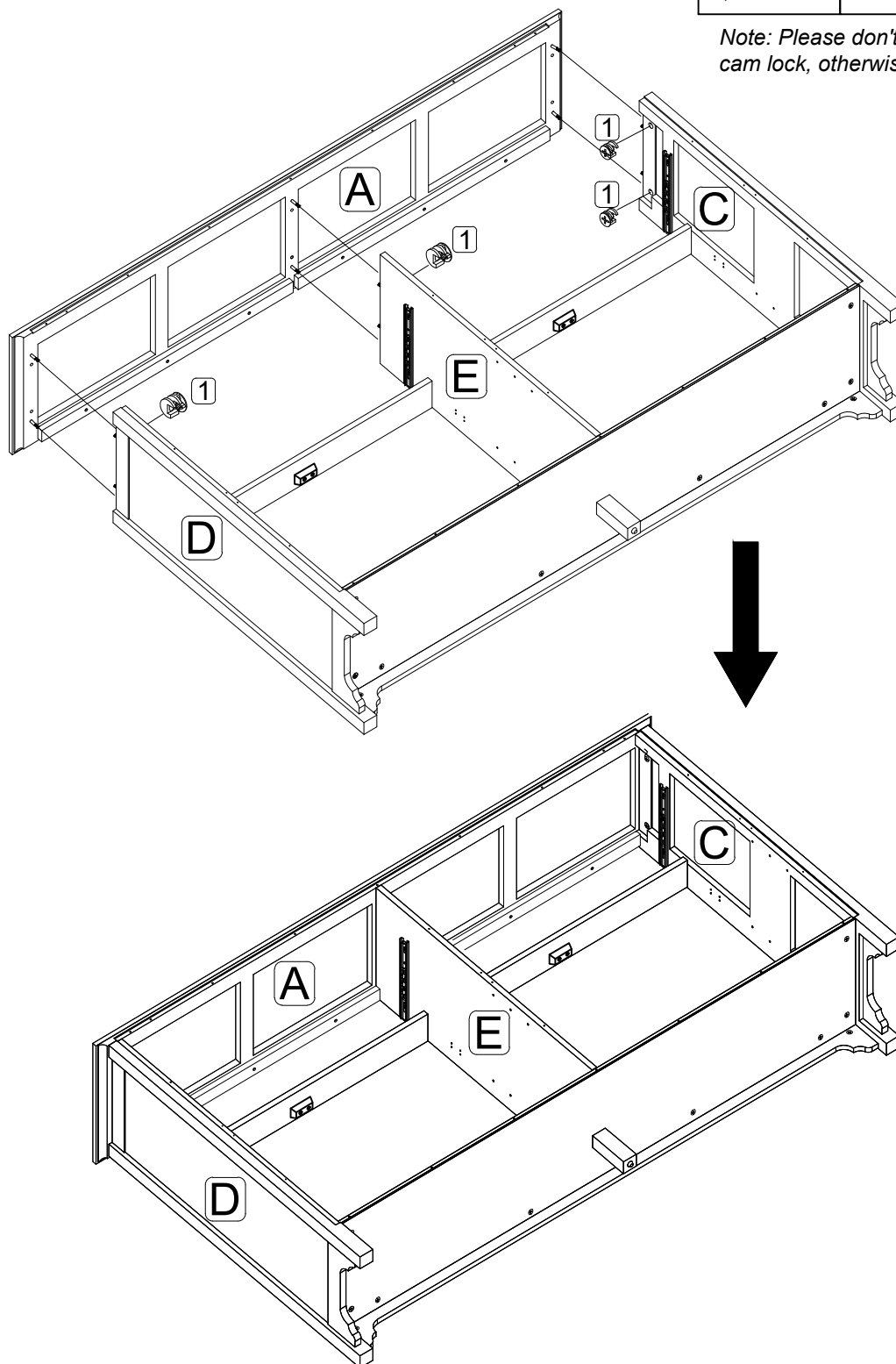

Use cam lock (1) secure parts (A) to the assembly with Philips head screwdriver as per diagram.

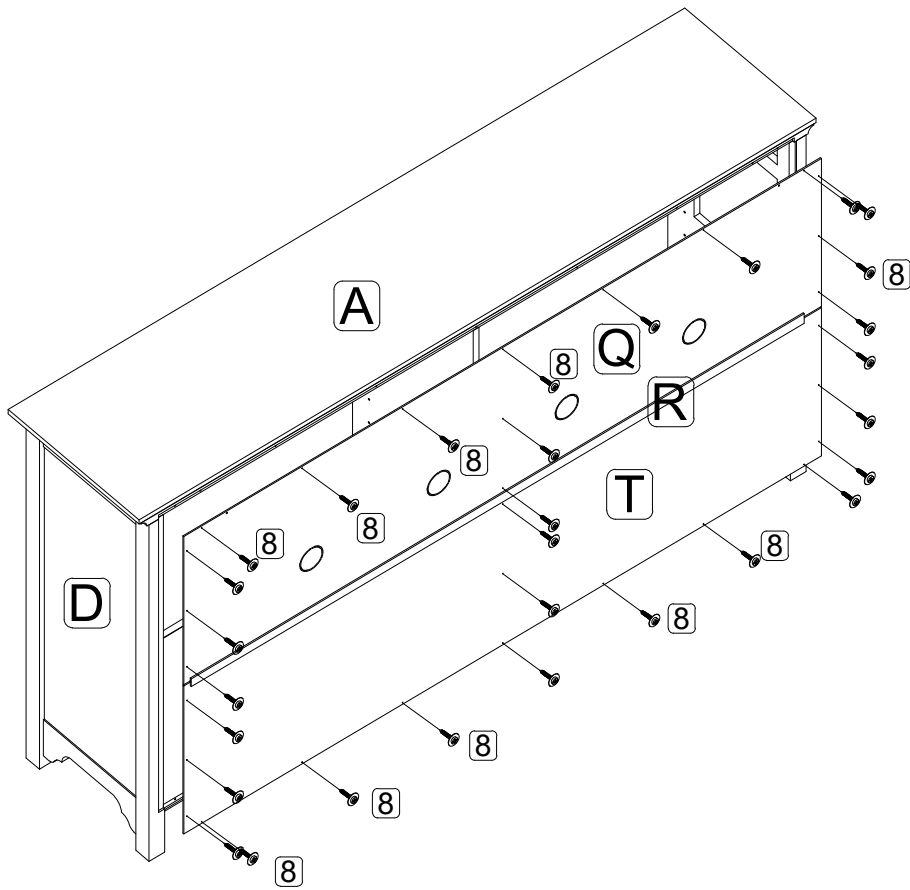
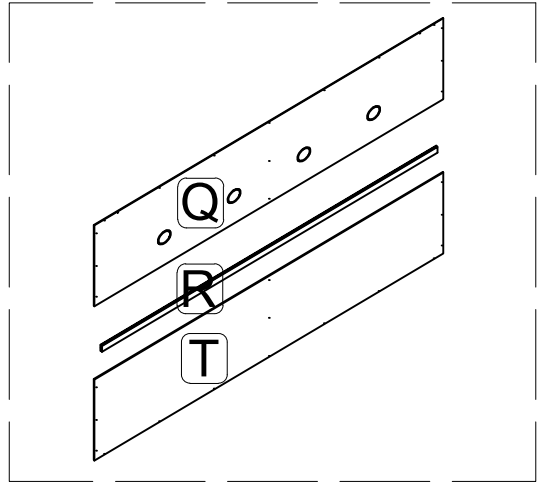

## Step 11

8:  30 pcs



Attach parts (Q,T) with part (R) as per diagram. Attach back panels (Q,R,T) to the assembly from the previous step by using screws (8).



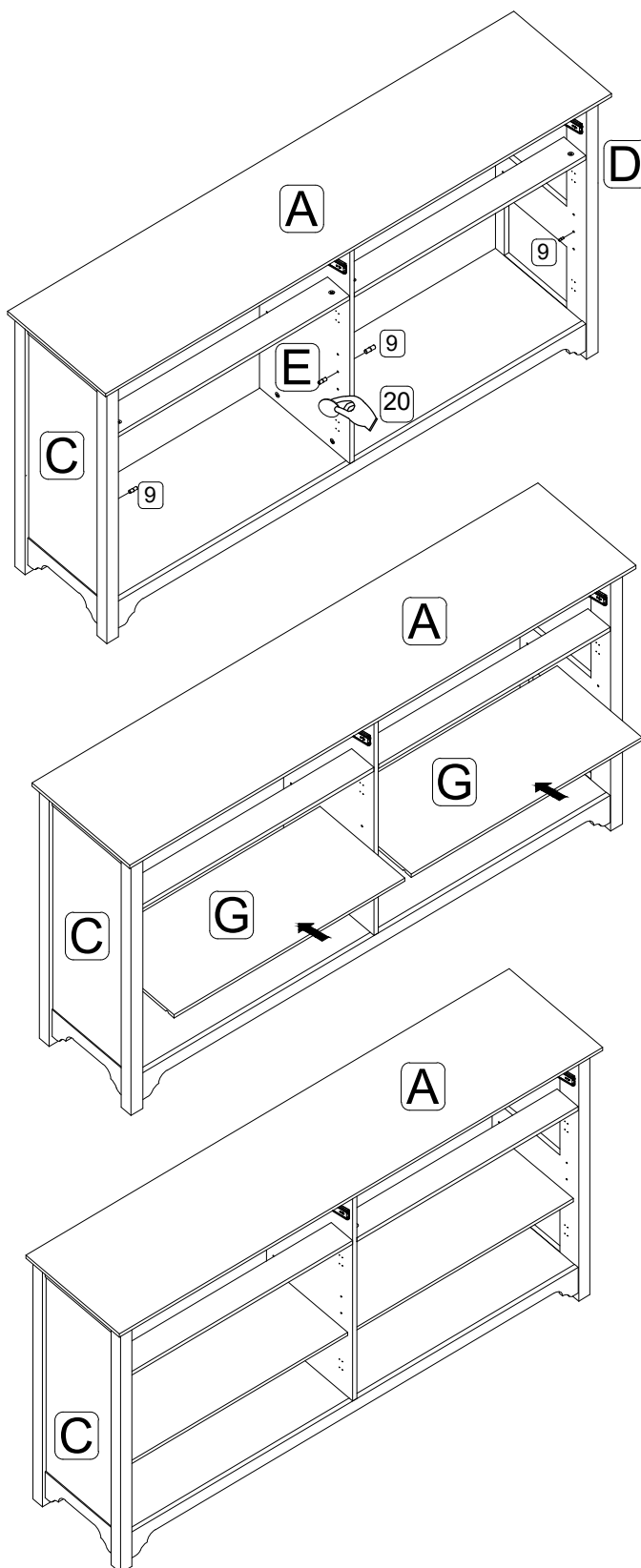

## Step 12

9:		8 pcs
20:		22 pcs



Insert shelf support pins (9) into the interior of the assembly at desired shelf heights. Carefully place shelves (G) on shelf support pins. Place sticker (20) cover the cam lock holes.

### Step 13

21:		2 pcs
4:		4 pcs
5:		4 pcs
13:		10 pcs

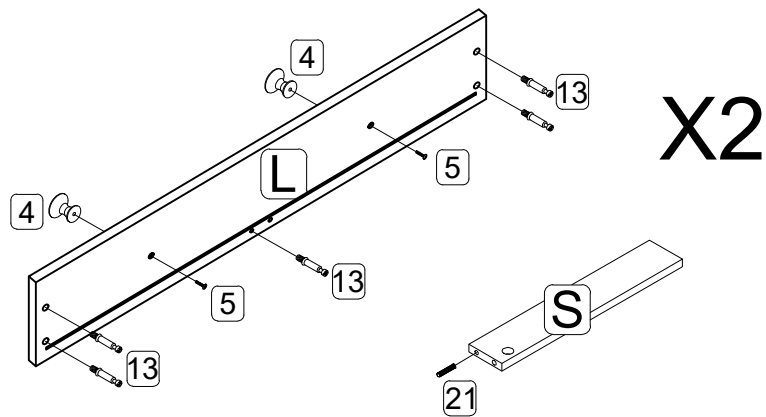

Using bolt (5) attach knob (4) into part (L) with Philips head screwdriver as per diagram. Secure cam bolt (13) into part (L) as per diagram.

Insert wooden dowels (21) into parts (S).

### Step 14

12:		12 pcs
-----	---	--------

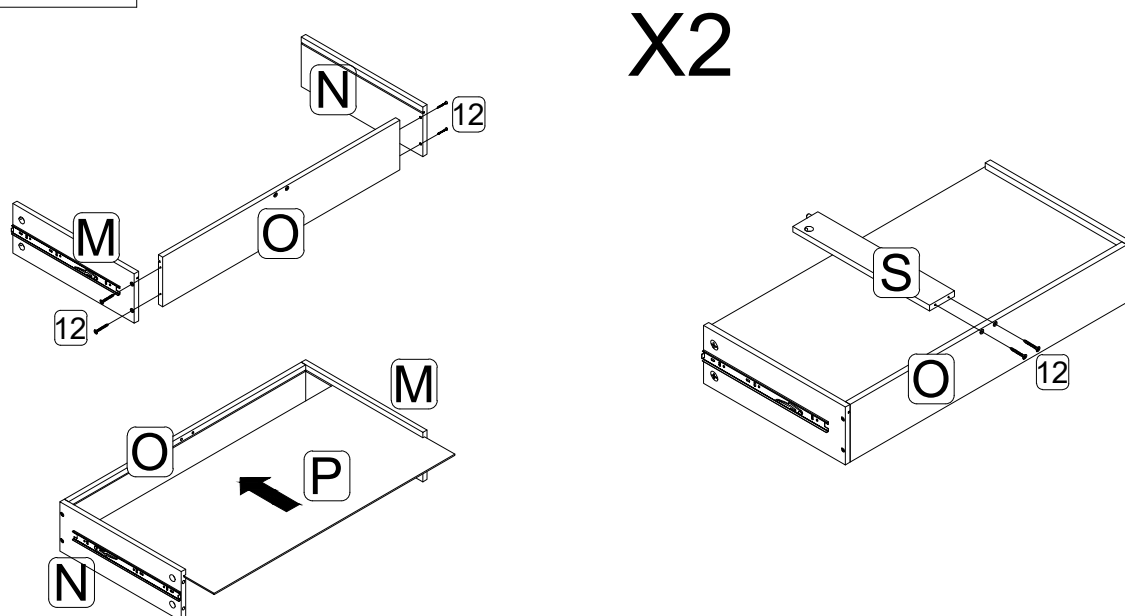

Using screw (12) attach parts (M,N) into part (O) with Philips head screwdriver as per diagram. Insert the panel (P) into parts(N,M,O) as per diagram. Then, secure part (S) to part (O) by using screw (12).

## Step 15

1:  10 pcs

20:  8 pcs

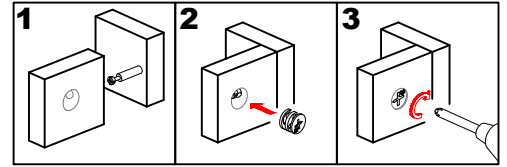

*Note: Please don't over-tighten the cam lock, otherwise, it will be broken.*

X2

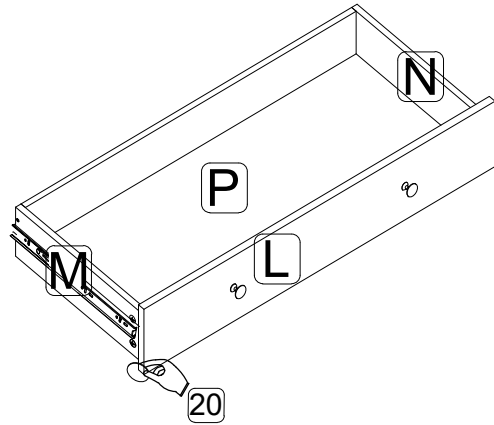
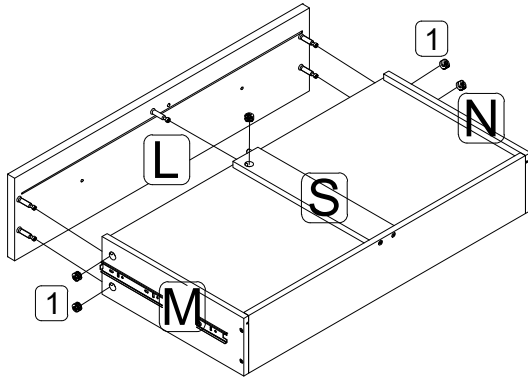



Use cam lock (1) secure parts (L) to the assembly with Philips head screwdriver as per diagram. Place sticker (20) cover the cam lock holes.

## Step 16

5:  8 pcs

6:  8 pcs

7:  16 pcs

15:  4 pcs

X4

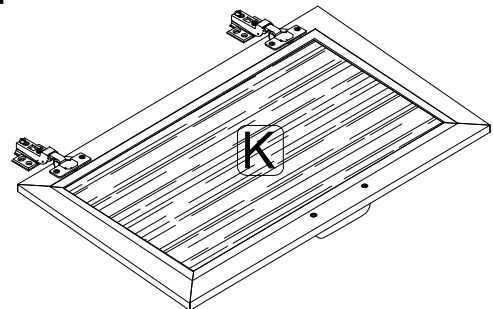
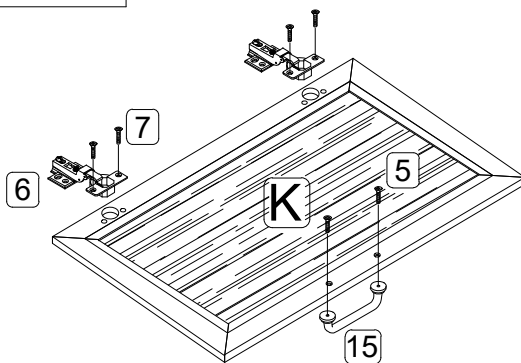

Use bolt (7) attach hinges (6) and use handle bolt (5) attach handle (15) into doors (K) with Philips head screwdriver as per diagram.



## Step 17

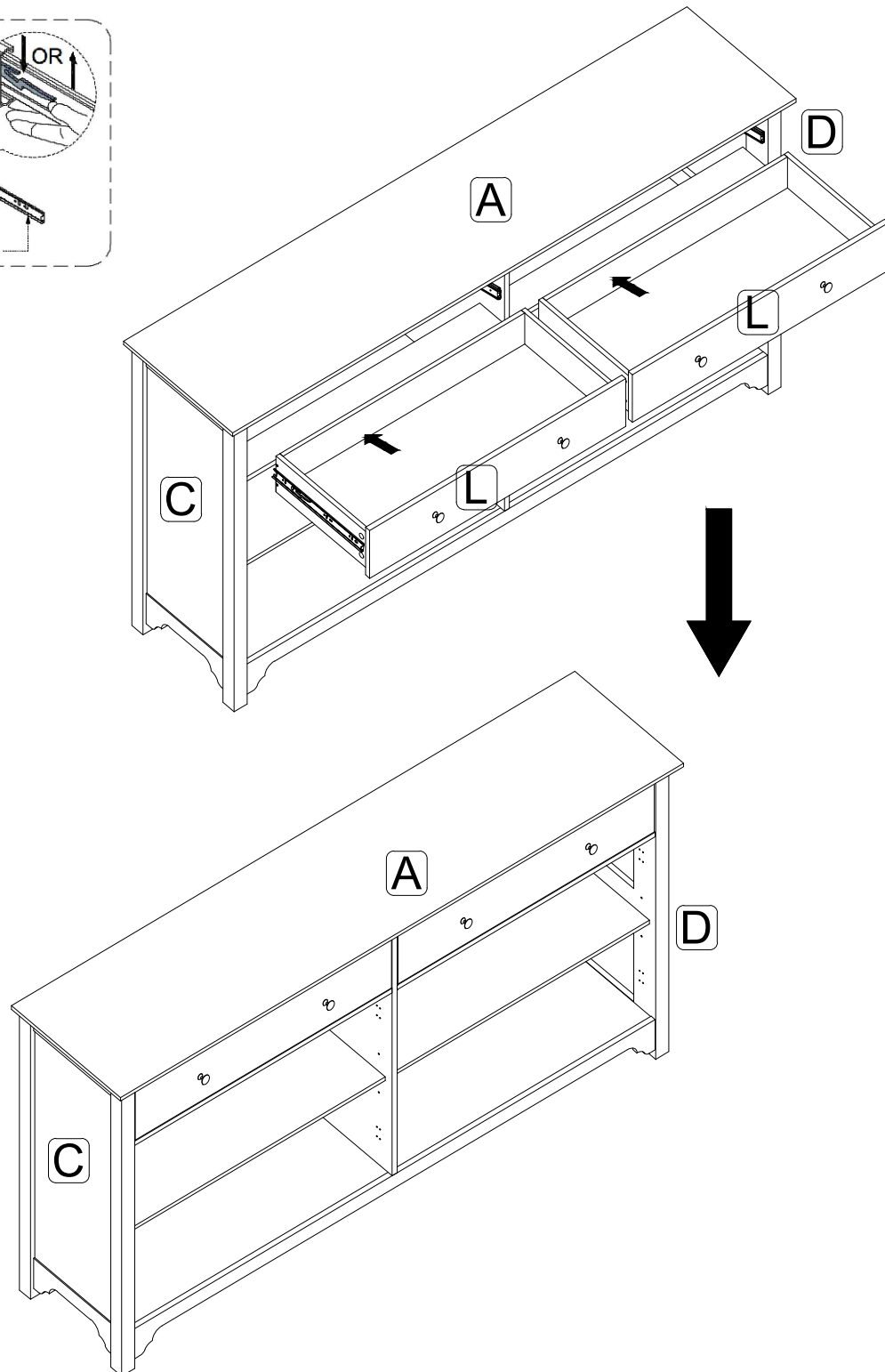
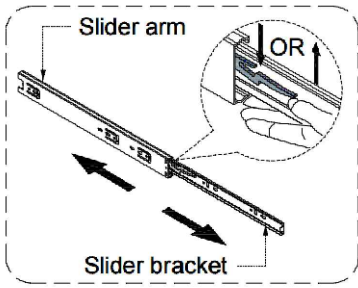

Insert the assembled drawers (L) into the unit frame, extend the Ball Bearing Slide Tracks on the pedestal Side Panel all the way forward. Then align the Slide Runners on the assembled drawers with the Slide Tracks and push the drawer carefully inside until it stops.

Note: if the drawer does not go in smoothly, please take it out and repeat the step. If you need to remove the drawer, please pull the drawer all the way out, press or lift the plastic release lever and pull out the drawer and then re-assembled the drawer until it was going in smoothly.



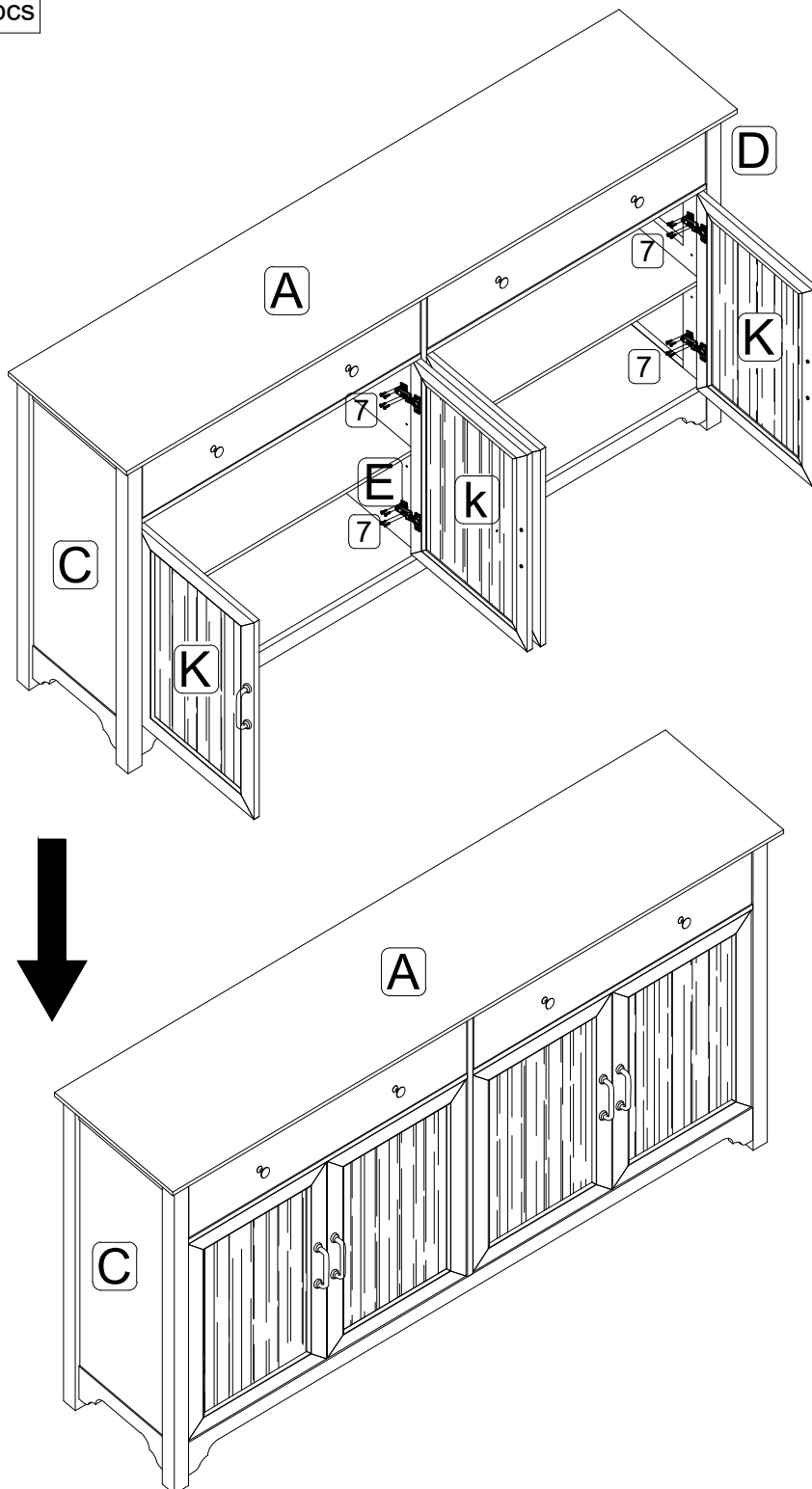

## Step 18

7:  32 pcs



Using bolt (7) attach hinge (E) into parts (C,D,E) with Philips head screwdriver as per diagram.

## Step 19

16:		2pcs
17:		2pcs
18:		2pcs
19:		2pcs

**WARNING**  
Serious or fatal injuries can occur from furniture tipping over. To prevent the furniture from tipping over we recommend that it is permanently fixed to the wall. Wall anchor and hardware are included with this product. Please make sure hardware is suitable for your walls before installing, as different wall materials may require different types of anchors.

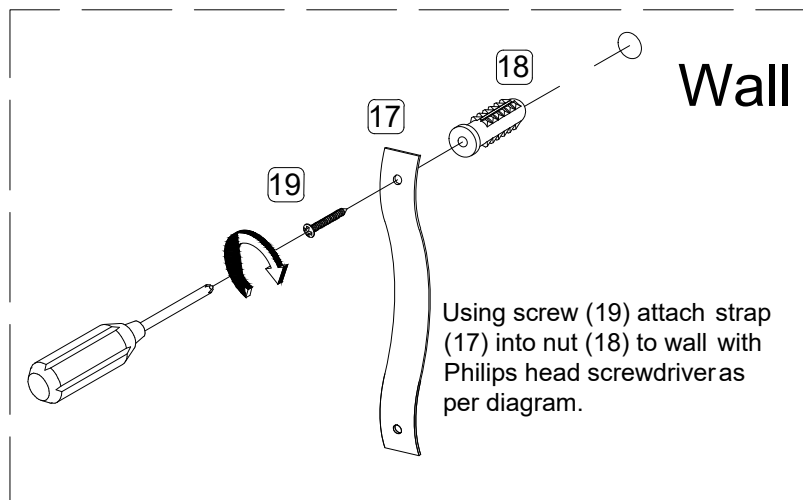
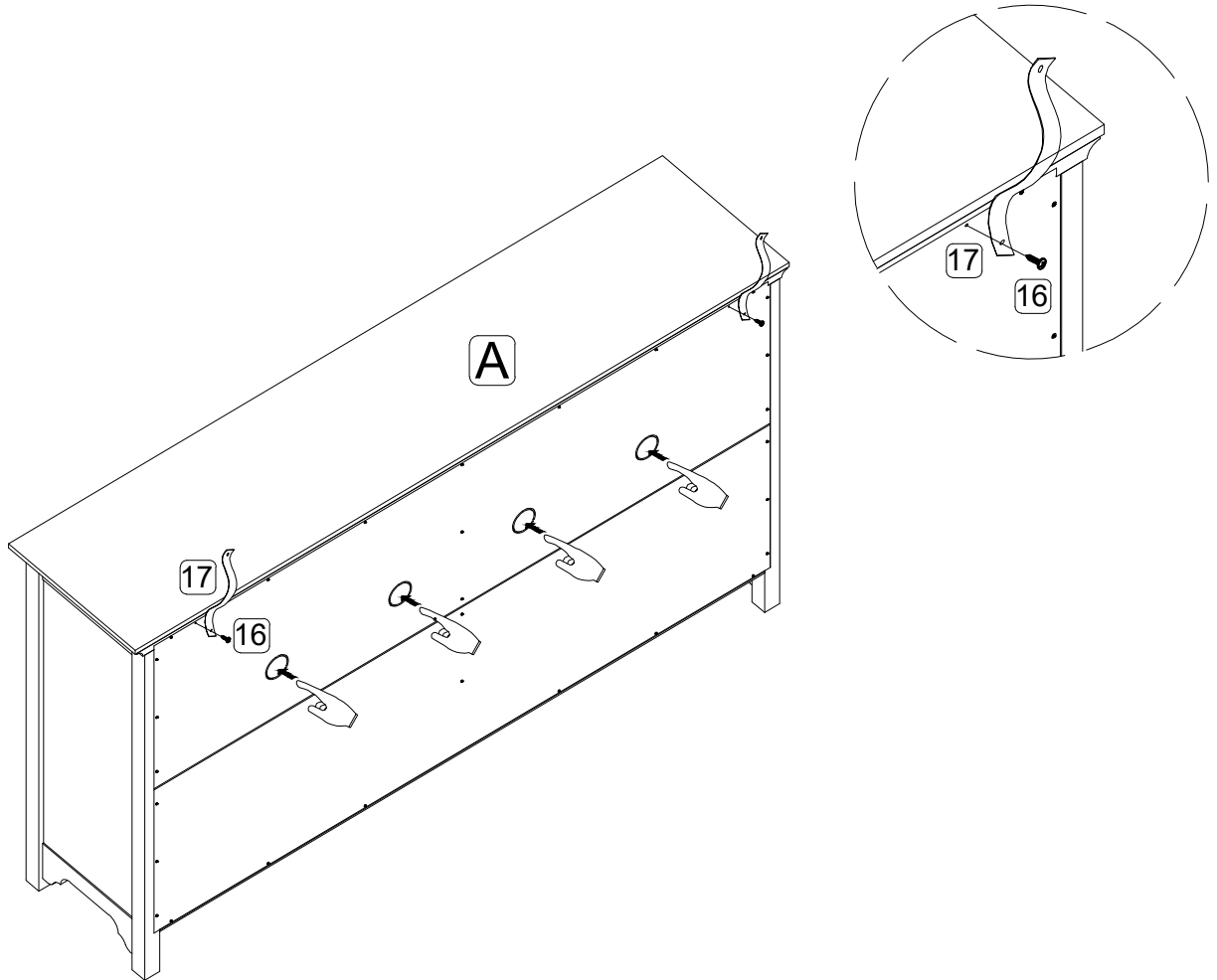

Take out the wooden panel of the faux cable holes if necessary.

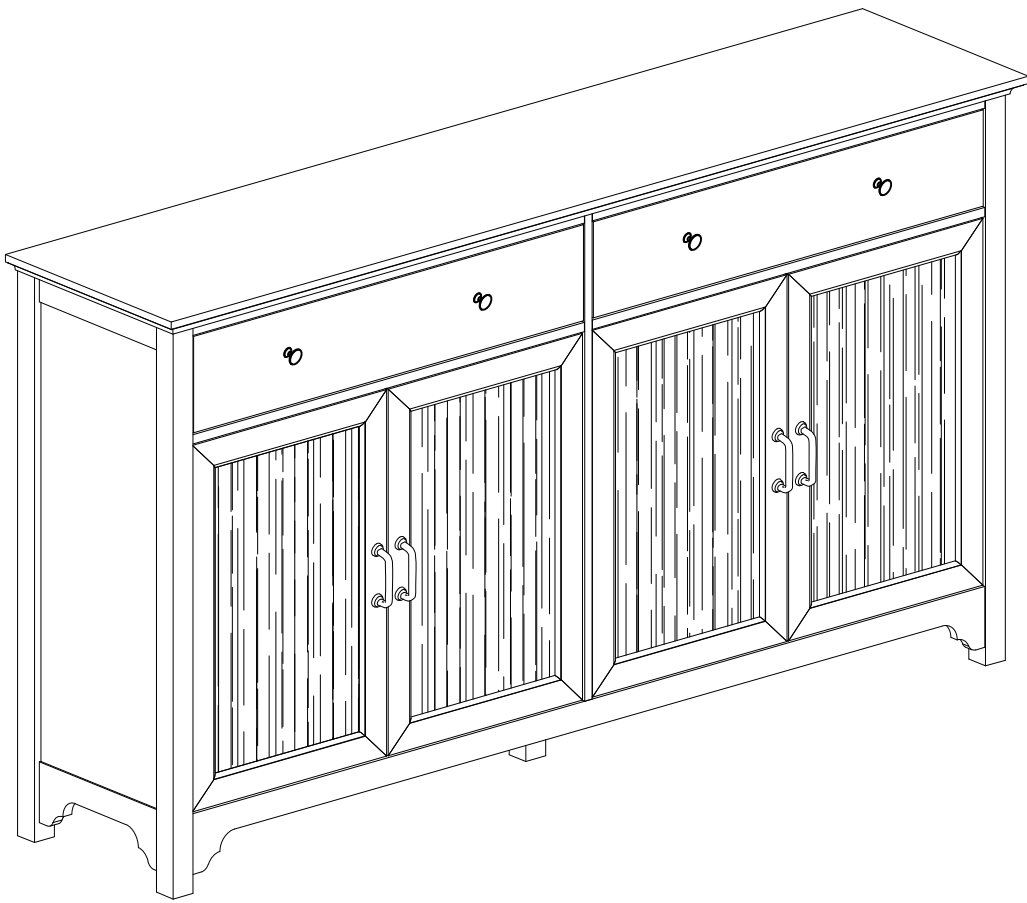

Final Assembly