

ES318155AAK

Thank you for your support.
Any problems during using please
contact us. We are at your service and
offer 1 year warranty.



INSTRUCTIONS OF SMART CAT LITTER BOX-GLB

Please read the manual carefully before using this product correctly . After reading, store this User Manual in an easily accessible place for all users. This product complies with the applicable requirements of directives 2014/35/EU (LVD),2014/30/EU (EMC) and 2014/53/EU (RED) .



Directory

1	Product Function Introduction	01
1.1	Parameters	01
1.2	Components	02
2	Notes of First Use	04
2.1	Preparation Before Unpacking & Use	04
2.2	Product Placement	05
3	Adding Litter	07
3.1	Cat Litter Type	07
3.2	Method of Adding Litter	08
4	Installation & Usage	09
4.1	Garbage Bag Installation and Usage	09
4.2	Placement for the Deodorizing Box	10
4.3	Air Duct Connection & Installation	11
4.4	Disassembly Method for the Cabin	12

5	APP Connection Method And Usage	13
5.1	App Connection	13
5.2	APP Main Interface	16
5.3	Share APP with Other & Change Device Name	17
5.4	APP Settings	18
5.5	View Video & Document Records	19
5.6	Identification Of Multiple Cats	20
6	Control Panel Funtions	21
7	Operation Process & Cleaning Recommendations	22
7.1	Operation Process	22
7.2	Cleaning Recommendations	23
8	Fault Self Inspection Method	24
9	Q&A	25
10	Compliance Statement	27

1 Product Description

1.1 Parameters

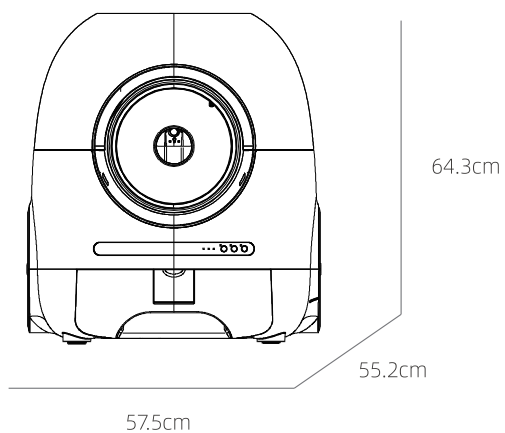

Product Name :	Electric Litter Box
Model:	ES318155AAK
Material :	ABS&PP
Product Size :	57.5×55.2×64.3cm
Drum Bin Size :	46x46x41cm
Net Weight:	14.8kg
Applicable to:	1-8kg cats
Adapter Power Voltage:	DC 12V
Machine Voltage:	110-240V

Power Rating:	15W
Wifi Support:	2.4G/b/g/n/a/c
App Language:	According to your phone language.
Drum Bin Capacity:	68L
Drawer Capacity :	9L
Recommended Litter Capacity:	7-8L
Recommended Litter Capacity:	Tofu/Bentonite/Mixed/ Sodium-based Litter
App Functions:	Clean/Empty/Fresh/Level
Gross Weight:	16kg

1.2 Components

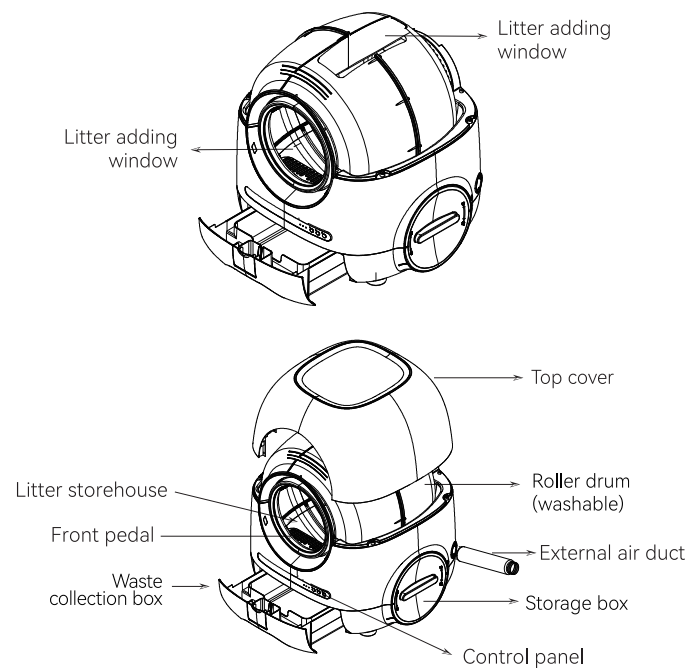

I Components

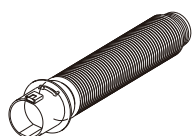
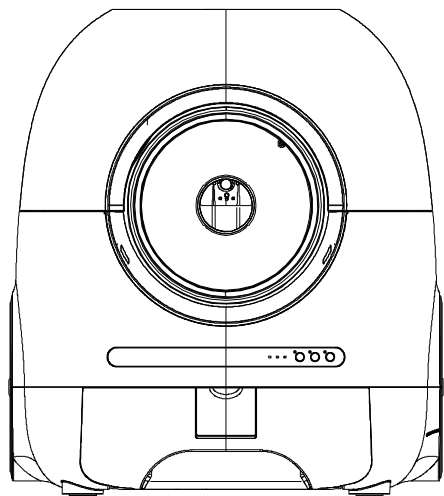

Air Duct x1

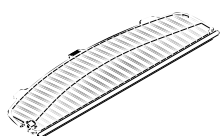

Normal Litter Filter x1



Tofu Litter Filter x1

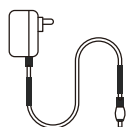

Power Adapter x1



Garbage Bags x1



User Manual x1

2 Notes of First Use

2.1 Preparation Before Unpacking & Use

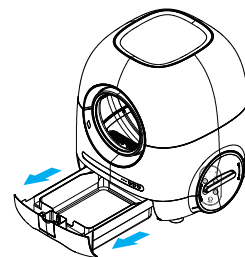

Step 1

① Remove the waste collection bin

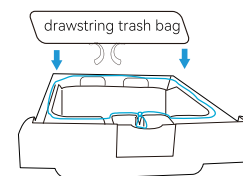

Step 2

② Install the garbage bag
(*refer to the instructions provided later for detailed installation steps)

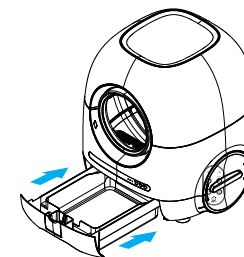

Step 3

③ Insert the waste collection bin

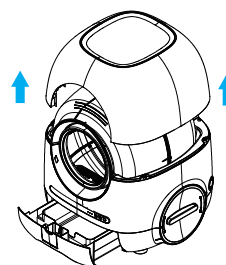

Step 4

④ Remove the top cover

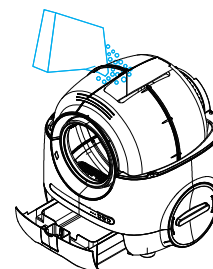

Step 5

⑤ Add appropriate amount of cat litter

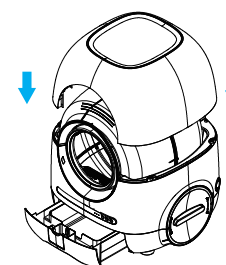

Step 6

⑥ Place the top cover back in position

2.2 Product Placement

- ① Please place the product on a flat and sturdy surface, preferably in an area with a good network environment.

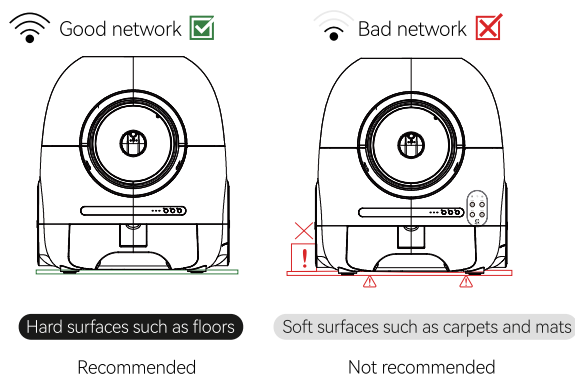

- ② Please avoid placing the device on soft surfaces such as cushions or carpets.

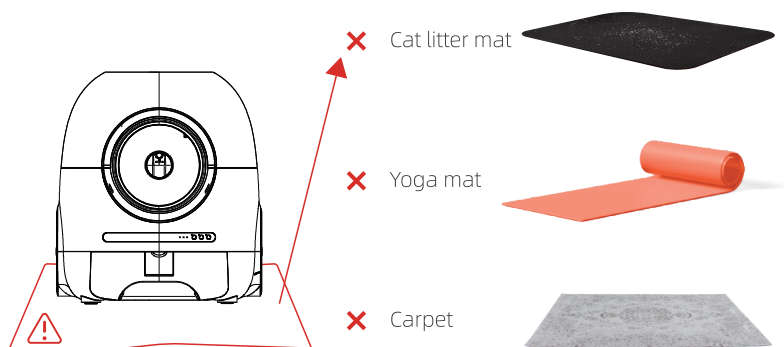

- ③ Only suitable for cats weighing 1-8kg.

Do not use the device's induction cleaning mode for kittens weighing less than 1kg and lactating cats.



1-8kg

- ④ Please do not place heavy objects on the top cover.
- ⑤ The host part of this device is strictly prohibited from soaking or soaking in water.
- ⑥ Please use indoors and avoid direct sunlight. Keep away from sources of ignition.



- ⑦ When moving, cleaning equipment, or not in use for a long time, please unplug the power cord.
- ⑧ Please use the original power adapter to avoid equipment damage or safety hazards.
- ⑨ If children are using this device, please ensure to use it under adult guidance.

3 Adding Litter

3.1 Cat Litter Type

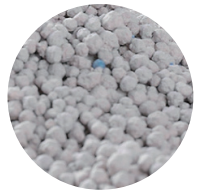

Bentonite litter



Mixed litter

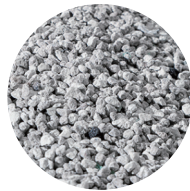

Sodium-based litter

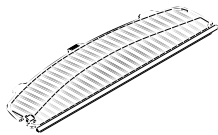

Normal Litter Filter x1

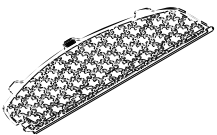

Tofu Litter Filter x1



Tofu litter

3.2 Method of Adding Litter

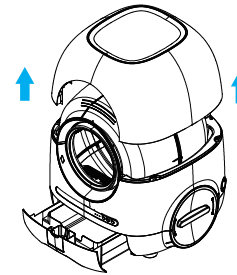

Step 1

① Lift the upper cover upward

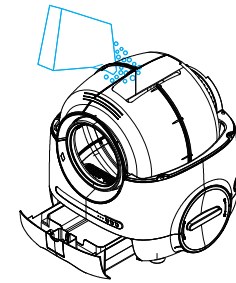

Step 2

③ Add cat litter from the top opening of the drum

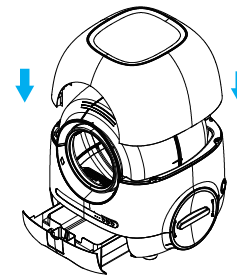

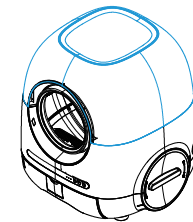

Step 3

③ After adding the cat litter, put the upper cover back in place



Step 4

④ Double-click  to release the child lock. Press the "Replace" button  to level the cat litter.

Notes: Please try to add cat litter from the upper part of the drum and put it back on the top cover. Then press the button .

4 Installation & Usage

4.1 Garbage Bag Installation and Usage

- After laying the garbage bag flat, insert the drawstring into the drawstring box at the front end. (Figure 1)
- When cleaning the feces, first open the drawstring box and pull out the drawstring, then the garbage bag can be securely sealed. Next, open the waste collection chamber. (Figure 2)

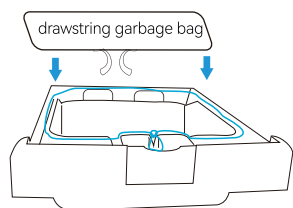

(Figure1)

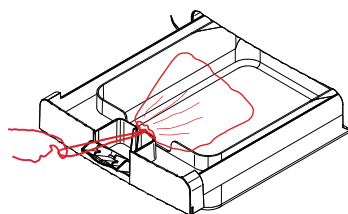

(Figure2)

Attention:

This product uses a 72.5*35cm garbage bag. If your garbage bag is no longer available, you can purchase this size yourself at the local supermarket.

4.2 Placement for the Deodorizing Box

- Please purchase deodorizer by yourself

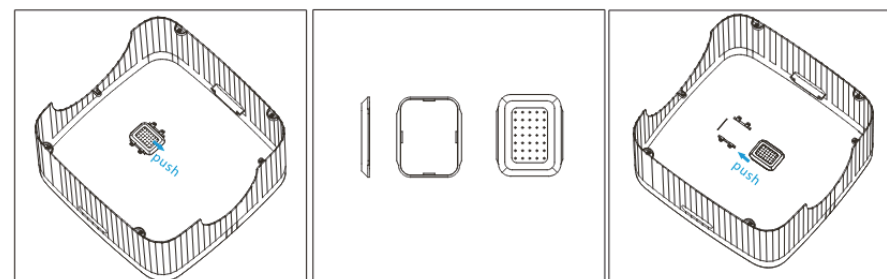

① Push out the deodorizer box in the direction indicated by the arrow.

② Open the box cover and place the deodorizing sheet (pack) inside the box.

③ Push and install the deodorizing box in the direction indicated by the arrow.

4.3 Air Duct Connection & Installation

- (1) Remove the rubber plug from the device's body ventilation duct interface.
- (2) Align the ventilation duct's outer interface protrusion with the duct socket on the device and insert it.
- (3) After inserting, rotate clockwise to lock the ventilation duct securely.
- (4) Rotate the ventilation duct counterclockwise to release it from the locking position and remove the duct.

Note: If the air duct is not installed or the air duct is installed incorrectly, the exhaust deodorization system of this product will not work.

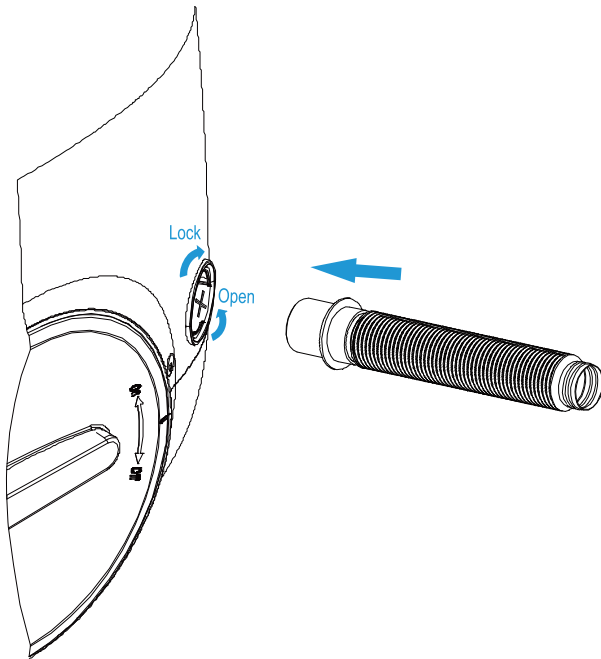

4.4 Disassembly Method for the Cabin

- (1) Remove the top cover.
- (2) Lift up the roller shaft pressure plate to remove the drum.
- (3) Push down the roller shaft pressure plate to lock the roller in place.

Tips: The cabin of this product can be removed, it is recommended to clean the cabin once every two weeks, after cleaning the cabin, the water stains should be wiped or dried before loading into the equipment.

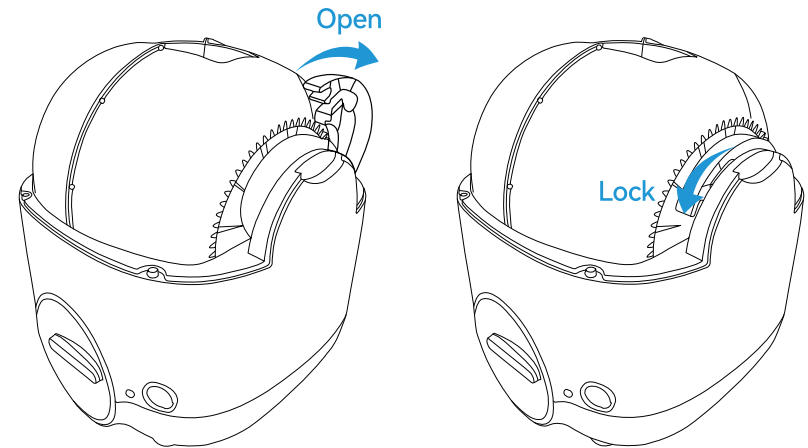

5 APP Connection Method And Usage

5.1 App Connection

- ① Install the Tuya Smart app from the app store or scan the QR code below.



Please scan the QR code to download and install the app.



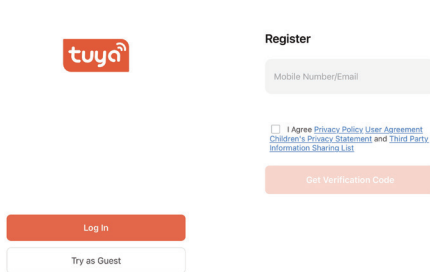

Download and install the app from the app store.

- ② Please open Bluetooth & location on your phone settings and make sure your phone is connected to 2.4G Wi-Fi.



- ③ After the installation is complete, please register an account.

- ④ Turn on your phone Bluetooth and connect Wi-Fi. Then, connect power source. If the network indicator light  is flashing slowly, it means it is waiting for network connection. If the indicator light is constantly on, you need to long-press the "Fresh" button  to reset the network settings of the device.

- ⑤ Adding device.

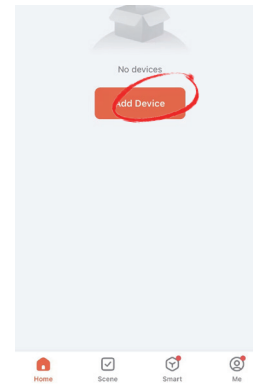

Step 1

- ① Open the Tuya Smart app and select "Add Device"

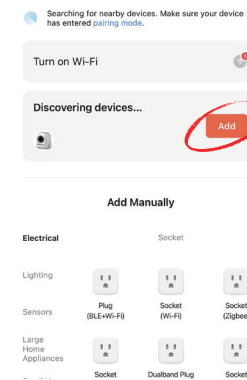

Step 2

- ② The device is automatically discovered via Bluetooth. Select "Add" to proceed

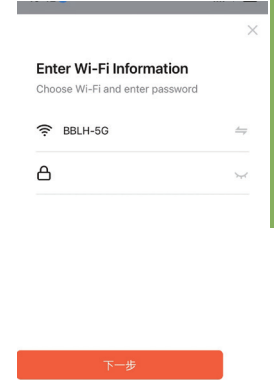

Step 3

- ③ Enter the correct Wi-Fi account and password

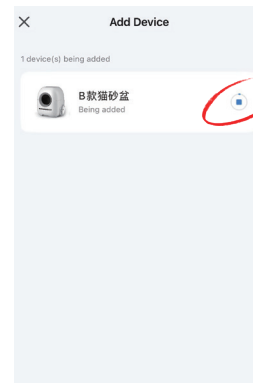

Step 4

- ④ Device is connecting to the network

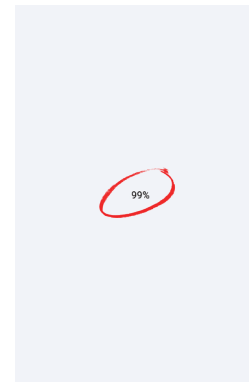

Step 5

- ⑤ Device is initializing



Step 6

- ⑥ APP Function Page

Notes:

If the network setup fails or times out, please check:

- To determine if your local Wi-Fi is working, you can check if other devices can successfully connect to and use the Wi-Fi network.
- Make sure that your phone has both Wi-Fi and Bluetooth enabled.
- Verify if the device is in pairing mode and if the Wi-Fi indicator on the panel is blinking. A slow blinking indicates that it is waiting to connect, while a fast blinking indicates that it is currently connecting.
- Check if there is a Wi-Fi network issue or if the network is down. Verify if other devices can connect to the network and use it properly.
- Make sure that you have entered the correct Wi-Fi account and password. Double-check the information you entered to ensure accuracy.

5.2 APP Main Interface

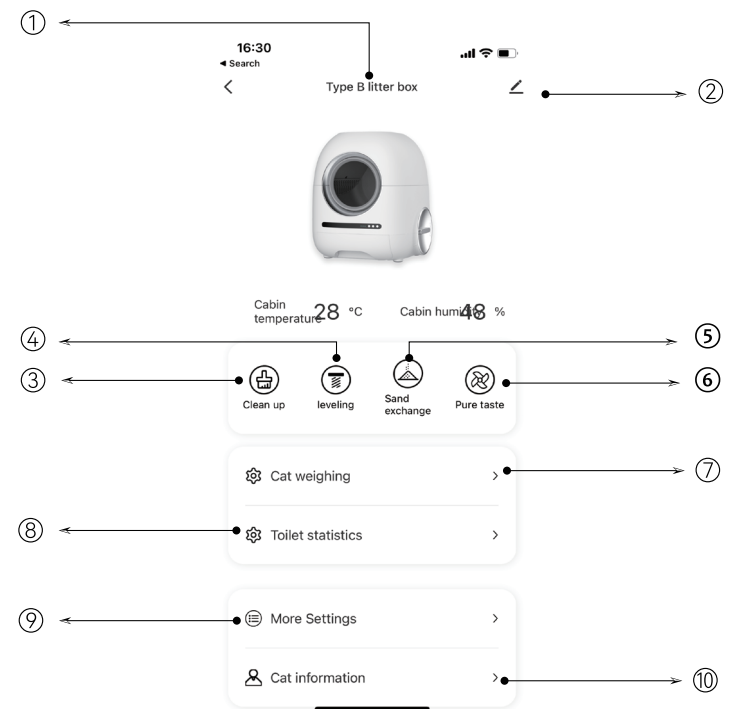

① Device Name (Customizable)

② System Settings

③ Clean

④ Level

⑤ Empty

⑥ Fresh (manual)

⑦ Cat weighing and toilet information

⑧ Toilet usage statistics

⑨ More: Device operation settings

⑩ Cat information

5.3 Share APP with Other & Change Device Name

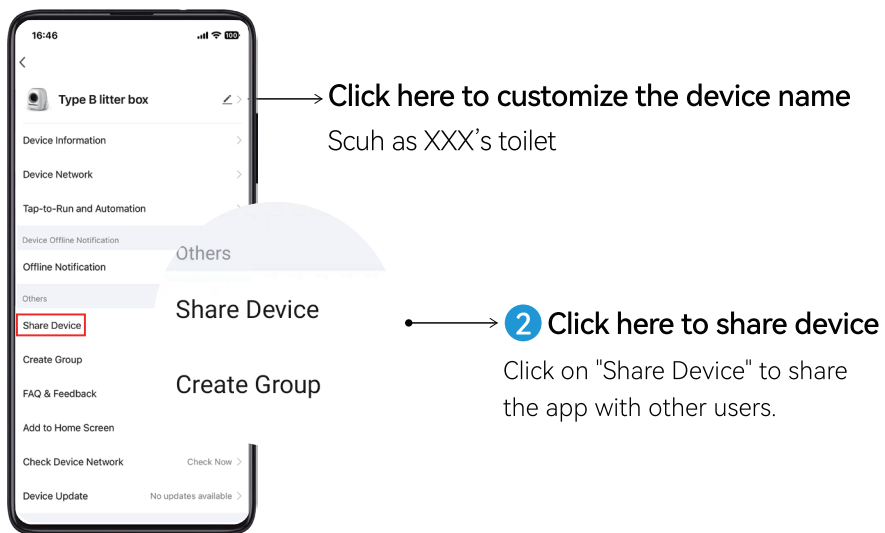
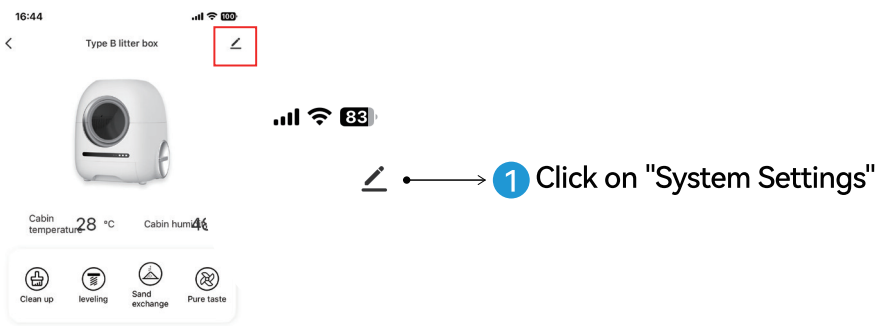

5.4 APP Settings

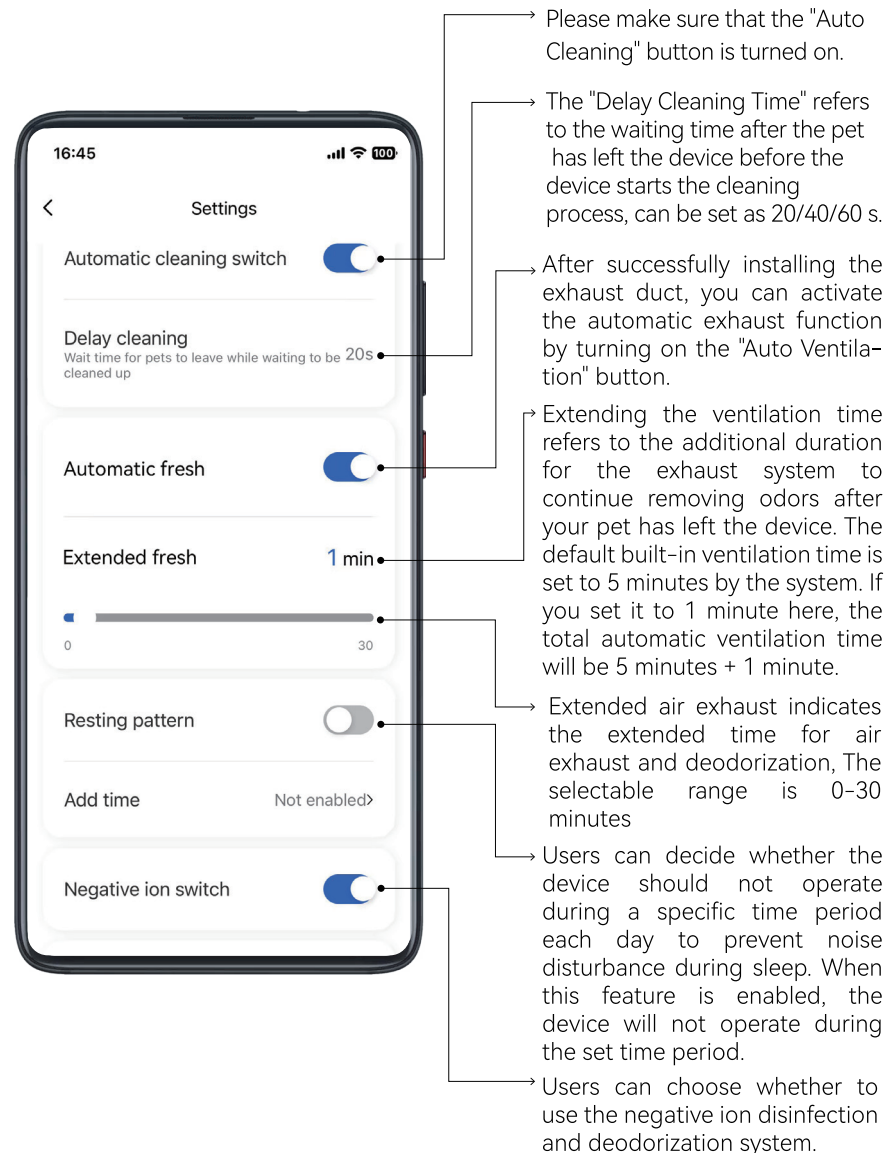

5.5 View Video & Document Records

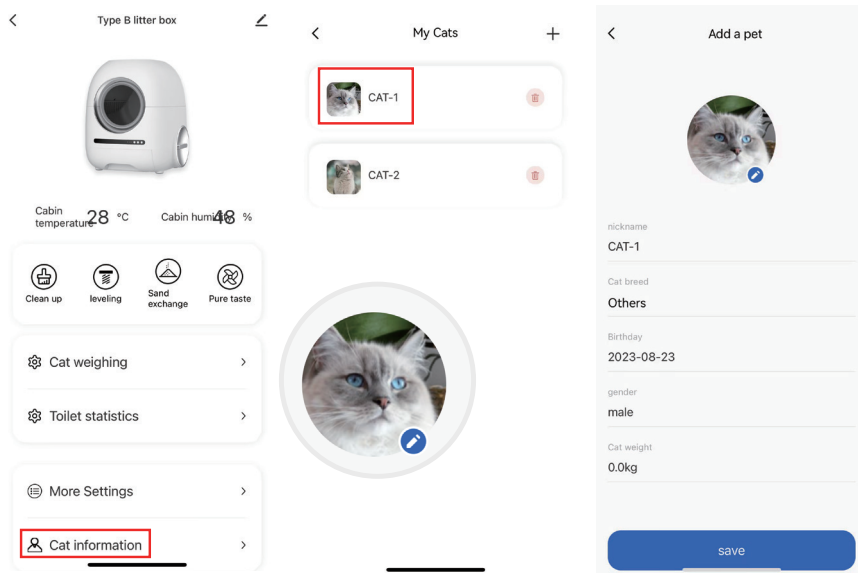

Step 1: After the pet uses the toilet for the first time and successfully gained its weight by the device, the device will prompt for "There is a new pet, go check it out".

Step 2: Click on "Cat Information" to enter the "My Cats" Page.

Step 3: Click on the pet to enter the "Pet Information" editing page, where you can add the pet's name, age, etc.

REMARKS: When the edited pet's weight changes within $\pm 200\text{g}$ or $\pm 0.44\text{ lbs}$, the device will recognize it as the same pet, and the device will automatically update the latest weight of the pet. However, if the weight difference between two pets is within $\pm 200\text{g}$ or $\pm 0.44\text{ lbs}$, the device may not be able to distinguish between two different pets, and in this case, the device may randomly allocate their toilet usage times. In addition, this product can recognize up to 3 pets.

5.6 Identification of Multiple Cats

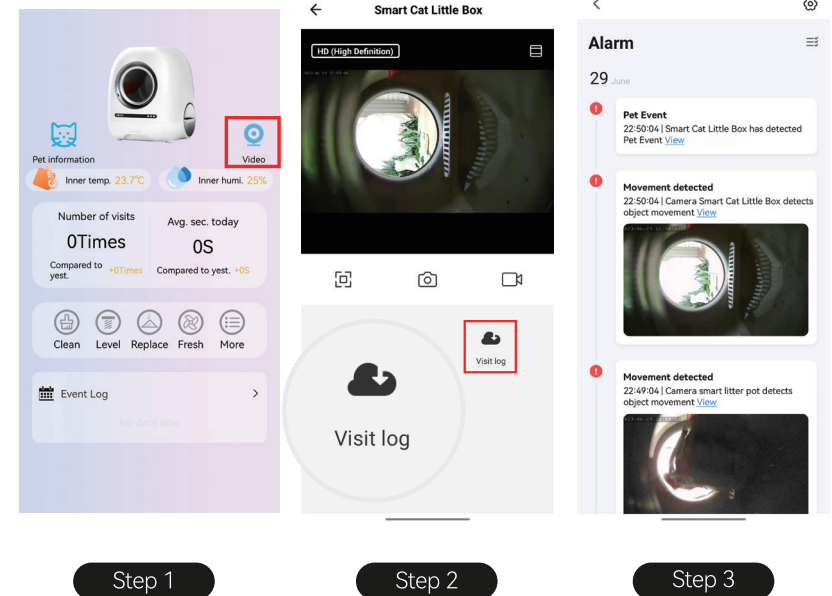

Step 1

Step 2

Step 3

Step 1: After the pet uses the toilet for the first time and successfully gained its weight by the device, the device will prompt for "There is a new pet, go check it out".

Step 2: Click on "Pet Information" or "There is a new pet, go check it out" to enter the "My Pets" Page.

Step 3: Click on the pet to enter the "Pet Information" editing page, where you can add the pet's name, age, etc.

REMARKS: When the edited pet's weight changes within $\pm 200\text{g}$ or $\pm 0.44\text{ lbs}$, the device will recognize it as the same pet, and the device will automatically update the latest weight of the pet. However, if the weight is difference between two pets within $\pm 200\text{g}$ or $\pm 0.44\text{ lbs}$, the device may not be able to distinguish between two different pets, and in this case, the device may randomly allocate their toilet usage times. In addition, this product can recognize up to 10 pets.

6 Control Panel Functions

● Introduction of Indicator Light Status:

Fault Indicator Light

- Solid red light: Roller drum is not installed properly or senses a moving object
- Red light off: The device is functioning properly.

Waste Collection Box Indicator Light

- Solid red light: The waste collection box is full and needs to be cleaned
- Red light off: The waste collection box is not full

● Button Functions Introduction:

Cleaning and Child Lock

- Short Press: Waste Cleaning and start odor control (green lights blink both)
- Short Press Twice: Disable child lock and red light off

Odor Control and Network Reset

- Short Press: Exhaust fans ventilate and deodorize (green light blinks), short press again it will be off (green light off)
- Long Press for 3s: Resetting Wi-Fi settings of the device, entering the waiting for network connection state

Child Lock: If there is no operation on the device panel for 30 seconds, the panel buttons will automatically lock (to prevent children and pets from accidental operation). In this state, cleaning button will have a constant red light. The Child Lock can be deactivated by which the red light on the button will turn off.

WiFi Indicator Light

- White light flashing slowly: Device is waiting for network connection
- White light flashing quickly: Device is connecting to the network
- Solid white light: Device is connected to the network
- White light off: Device disconnection

Leveling and Scooping

- Short Press: Leveling the litter (light blinks)
- Long Press for 3s: Replace the litter and start odor control (green lights blink both), the device will dump the existing litter into the waste collection box

7 Operation Process & Cleaning Recommendations

7.1 Operation Process

- The pet enters the device, completes the defecation, and then leaves the device.
- The device will capture a photo of the pet's feces and upload it to the "Toilet Records" section in the mobile app management system.
- The exhaust deodorization system starts working and eliminates odors.
- The device starts to operate and clean the pet's excrement.
- After the door is opened, wait for the exhaust deodorization system to finish its work. Then, the negative ion generator starts working to disinfect and sterilize the device, as well as further eliminate odors.
- The device has finished its operation.

7.2 Cleaning Recommendations

- Please try to keep the entrance of the drum clean as much as possible, clean hair and other dirt in a timely manner, and avoid interference with the infrared radiation sensor at the cabin door.
- Please clean the feces in a timely manner to avoid the collection bin being full, which may cause the equipment to stop running.
- It is recommended to clean the drum once every two weeks. After cleaning the drum, the water stains need to be wiped dry or air dried before being loaded into the equipment.
- We have adopted intelligent ventilation, negative ion and other technologies to maximize the purification and deodorization of odors, but this does not mean that the odor emitted by pet excrement can be completely removed. Therefore, it is necessary for you to regularly clean the feces in the collection bin and clean the silo to ensure a clean home environment.

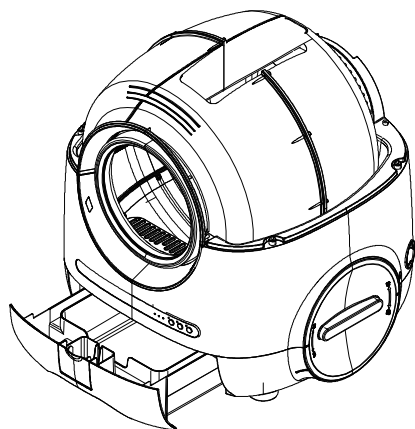

8 Fault Self Inspection Method

- When you disconnect the power supply of the device and reconnect it, the product will go through a self-checking process. During this period, please do not press any buttons or place any objects on top of the litter bin. Please wait patiently for the self-checking process to complete.
- Activate Cleaning, Leveling, Replacing program once for each, to ensure they are working properly.
- If the ventilation system is not working properly, please ensure that the ventilation duct is properly inserted. After inserting the ventilation duct, rotate it clockwise to ensure that the sensor located near the ventilation duct is in the correct position. Manually initiate the "Fresh" function to check if the fan is working properly.
- To manually operate the control panel, you need to deactivate the "Child Lock" function. Otherwise, the control panel buttons will not respond.
- When initiating the automatic cleaning, leveling, or replacing functions of the device, it is recommended to maintain a distance of 1 meter or 3.2 feet from the device. This distance allows for the proper operation of the device and ensures pets' safety.

9 Q&A

Questions	Answers
1.What is the maximum number of cats that the multi-cat mode can recognize?	1.It can recognize up to 10 cats weighing between 1-12kg or 2.2-26.5 pounds at most.
2.Why does the litter box rotate automatically after power on? Why does the sensor cleaning light turn on without me making any settings?	2.Because the device performs a self-check program every time it is powered on after a power outage, and the litter box returns to its initial position. This process takes approximately 2 minutes. After the self-check is complete, the device automatically enters the cleaning mode, and the sensor light turns on. If you need to make other mode settings, you can adjust them manually.
3.Why does the device take a long time to clean?	3.The device is designed with a special program that reduces the cleaning operation speed. This is done to lower the noise level of the device and save on cat litter usage. It takes approximately 2 minutes to complete a standard cleaning cycle. Additionally, the high curiosity of cats near the device, which interrupts the operation, can also contribute to extended cleaning time. The lower speed is beneficial for timid cats as it reduces resistance.
4.Why does the device rotate during the cleaning process?	4.The "sand-saving rotation" and "dynamic waste collection" features are specifically designed in this product to save cat litter usage and increase the capacity of the waste collection bin. Therefore, during the cleaning process, there will be a reverse rotation and occasionally a small amount of waste may roll out of the waste collection bin. This is within the normal operation of the device, and after the cleaning is complete, all waste will be collected back into the waste collection bin.
5.Why can't the waste enter the waste collection bin when I clean it up?	5.It could be due to the waste collection bin being blocked by improperly placed cat litter or garbage bags, or the waste being too large to pass through. Please check if the waste collection bin can open and close smoothly. It is recommended to perform a check after installing a new garbage bag. The dimensions of the waste collection bin door are 350*450mm. If there is oversized waste, it can be manually processed to a smaller size before cleaning again.

Questions	Answers
6.Why is clean cat litter being dumped into the waste bin during cleaning?	6.Please add cat litter according to the indicated amount inside the litter box. Adding too much cat litter can cause it to exceed the capacity of the separator inside the litter box, resulting in excess litter being dumped into the waste bin, leading to litter waste.
7.Do I need to clean the litter box by water? How often should I clean it?	7.The litter box and waste collection box can both be removed and washed with water. It is recommended to clean them approximately every two weeks to maintain a clean indoor environment and provide your pet with a clean and tidy toilet.
8.Why is there still leftover litter in the litter box after using the litter replacement function?	8.The litter replacement function of the device is designed to pour the litter from the litter box into the waste collection bin. If the waste collection bin is already occupied by feces and doesn't have enough capacity, it may result in some litter not being successfully emptied into the bin. In such cases, you can try replacing the garbage bag and then perform the litter replacement function again.
9.Why is my litter box unable to weigh my cat accurately?	9.If your litter box is unable to weigh your cat accurately, please click on the "Leveling" mode. The device will recalibrate when the litter is leveled, and it will measure the weight again when the cat re-enters, automatically performing weight calibration. To avoid inaccurate weighing, please place the litter box on a flat, hard surface to ensure the gravity sensor can function properly.

10 Compliance Statement

This device complies with Part 15 of the FCC Rules.

WARNING: Operation is subject to the following two conditions: (1) This device may not cause harmful interference, and (2) This device must accept any interference received, including interference that may cause undesired operation.

CAUTION: Changes or modifications not expressly approved by the party responsible for compliance could void the user's authority to operate the equipment.

NOTE: This equipment has been tested and found to comply with the limit for a Class B digital device, pursuant to Part 15 of the FCC Rules. These limits are designed to provide reasonable protection against harmful interference in a residential installation. This equipment generates, uses, and can radiate radio frequency energy and, if not installed and used in accordance with the instructions, may cause harmful interference to radio communications. However, there is no guarantee that interference will not occur in a particular installation. If this equipment does cause harmful interference to radio or television reception, which can be determined by turning the equipment off and on, the user is encouraged to try to correct the interference by one more of the following measures:

- Reorient or relocate the receiving antenna.
- Increase the distance between the equipment and receiver.
- Connect the equipment into an outlet on a circuit different from that to which the receiver is connected.
- Consult the dealer or an experienced radio/TV technician for help.