

# Assembly Instructions

## Poly Plastic Adirondack Chair



**CAUTION:** This Adirondack is NOT a TOY.

Keep your child / children at bay during the assembly process.

For moving the Adirondack and to prevent damages, two adults are needed to execute this action.

Please keep this instruction manual for future reference.

### Adirondack Chair Installation and Maintenance

1. Do not fully tighten all bolts until all parts are in place. Failure to follow these instructions may cause the bolts to misalign during assembly























2. Please keep away from extreme heat and strong oxidizing agents

3. Under the sun, there is no need to cover the chair with an airtight dust cover, as the high temperature will deform the material

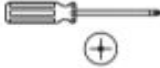
4. In an outdoor environment, the chair does not require any protection, No need to paint or stain, and only need to wash with soap, water and soft bristle brush or sanding sponge

5. Children should not climb or jump on the chair

# Pre-Assembly

Part list							
Label	Description		Qty	Label	Description		Qty
①		Seat panel	1 pc	A		Bolt M6*70MM	2 pcs
②		Front left leg	1 pc	B		Bolt M6*60MM	2 pcs
③		Front right leg	1 pc	C		Bolt M6*55MM	4 pcs
④		Left armrest	1 pc	D		Bolt M6*50MM	2 pcs
⑤		Right armrest	1 pc	E		Bolt M6*45MM	6 pcs
⑥		Backrest	1 pc	H		M6 Self-locking Nut	10 pcs
⑦		Rear Seat Slat	1 pc	I		Screw M4*40MM	8 pcs
⑧		Back Support Slat	2 pcs	J		Spanner	1 pc
⑨		Front Leg Cross Beam	1 pc	K		Screwdriver	1 pc
⑩		Back Leg Cross Beam	1 pc				
 • Read instructions, cover to cover-  • Have 2 adults on hand for assembly-  • Do not assemble on flooring or carpet-  • Assemble on a clean non-marring surface (packing foam)-  • Save all packaging until finished-							

**Before assembling, please check if you have all the parts on the assembly instructions.**

# Assembly Steps

## Step 1

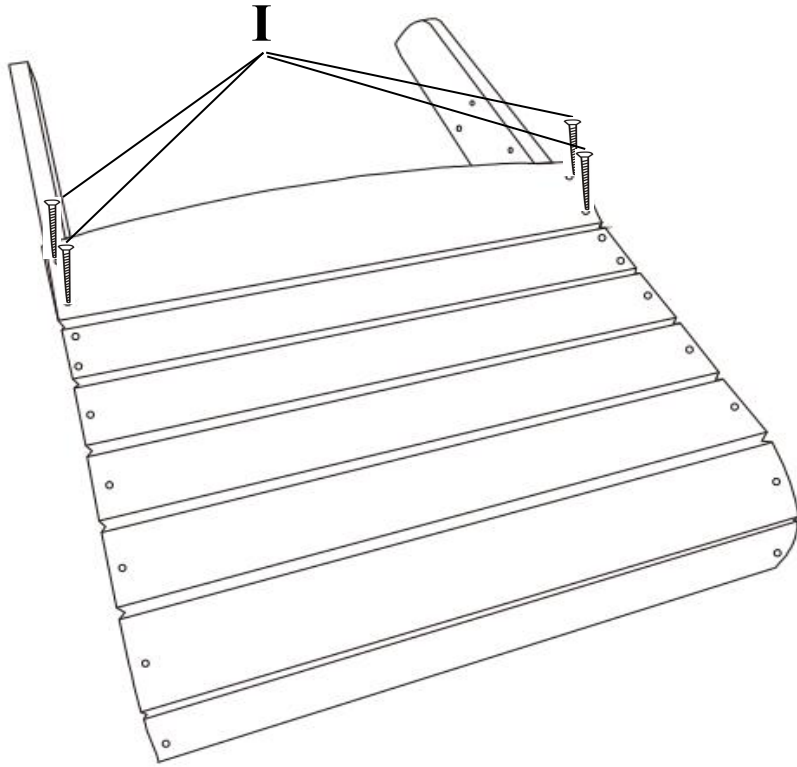

## Step 2

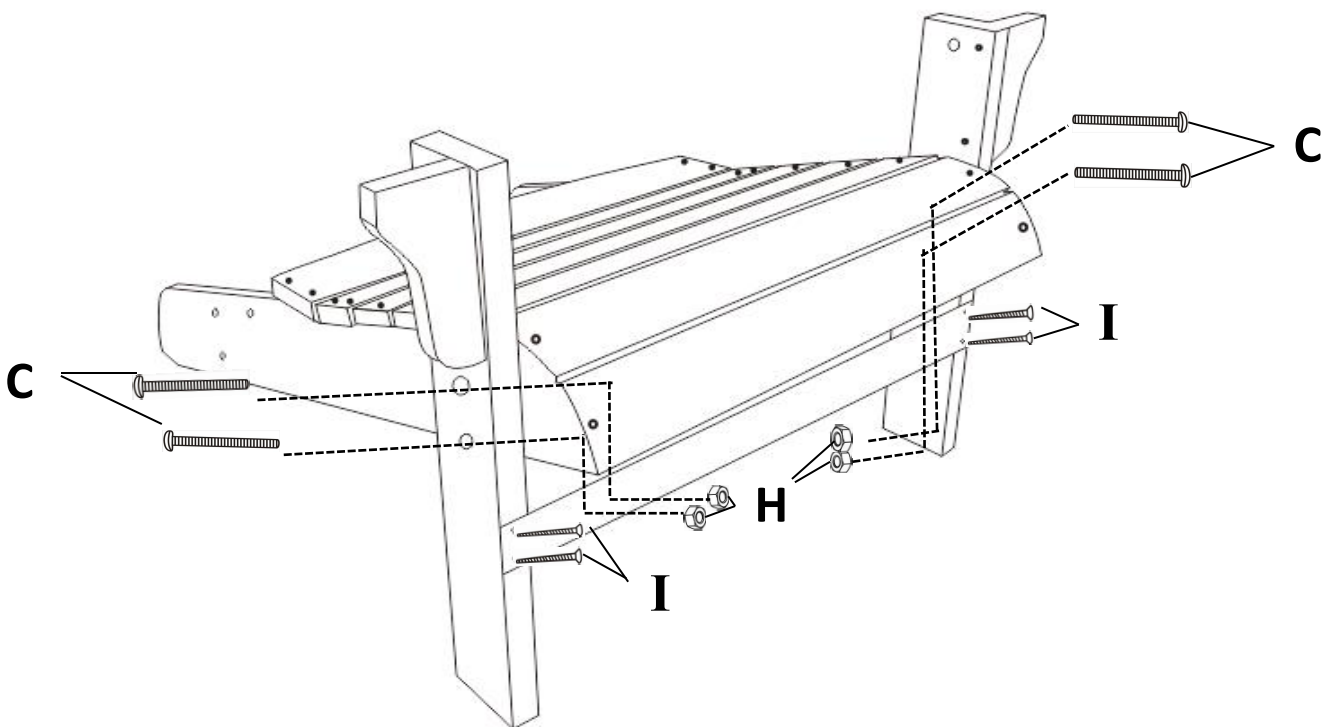

### Step 3

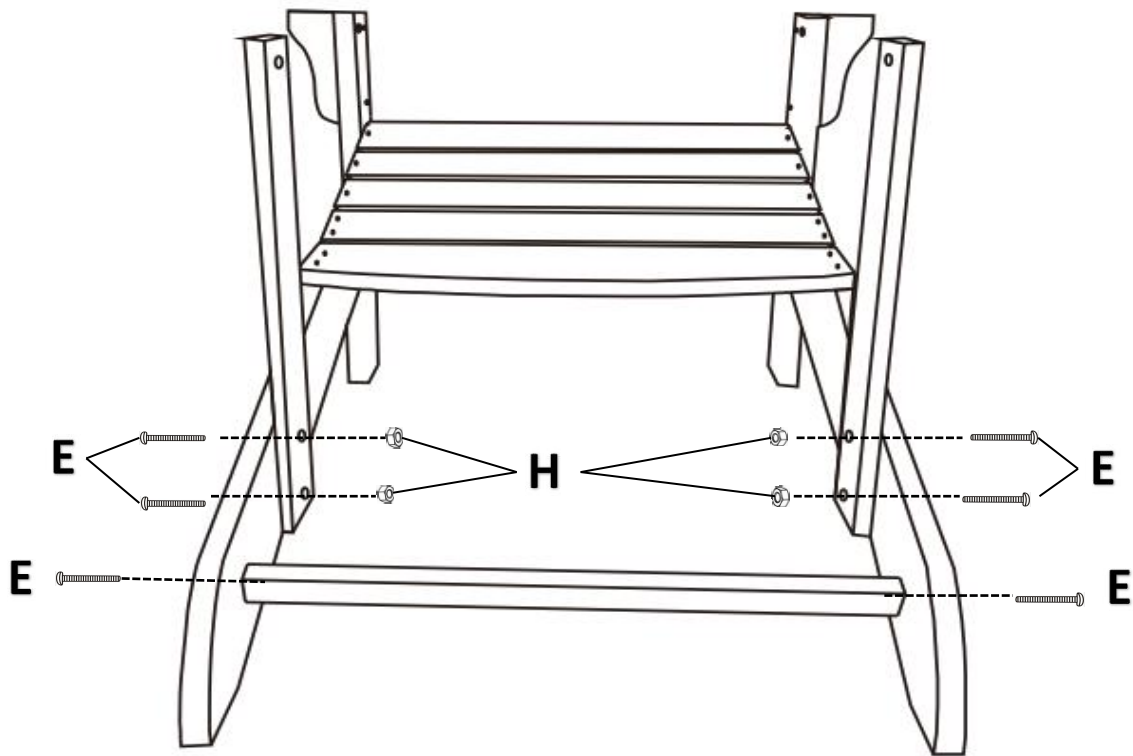

### Step 4

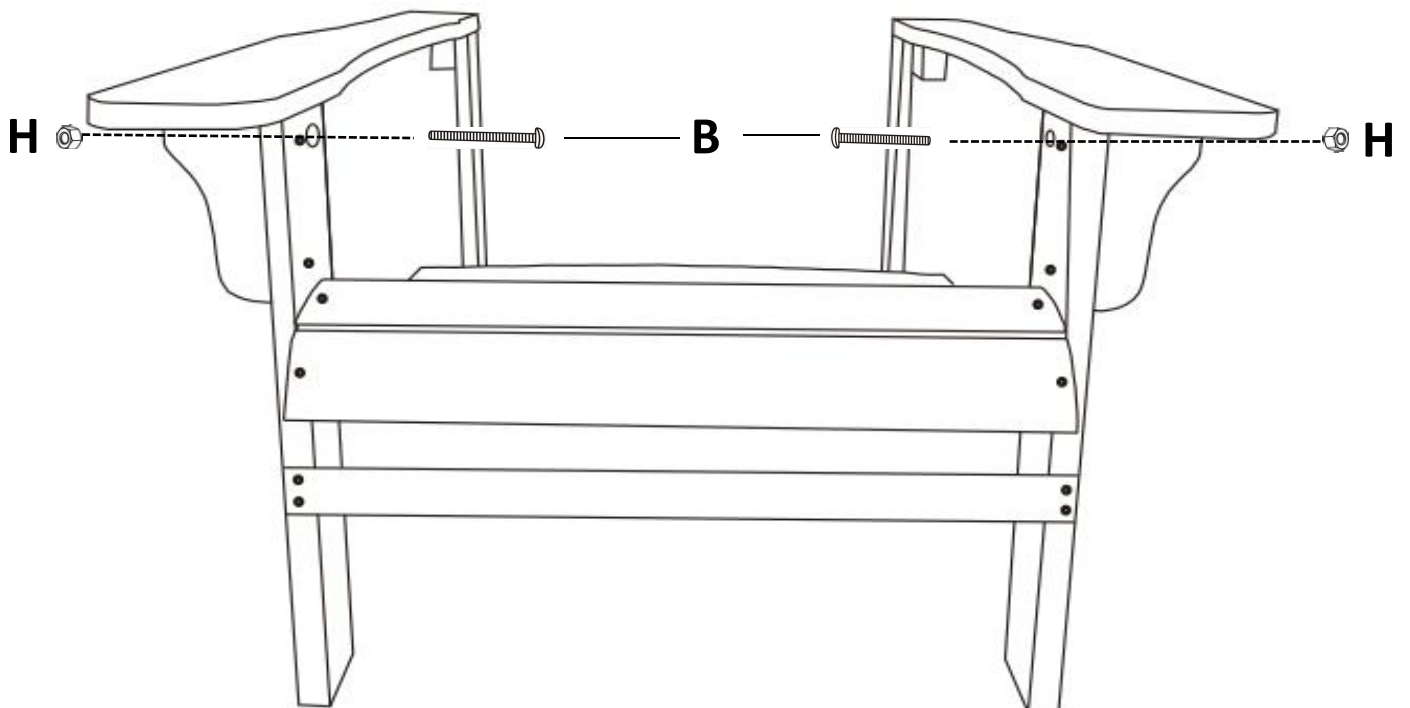

## STEP 5

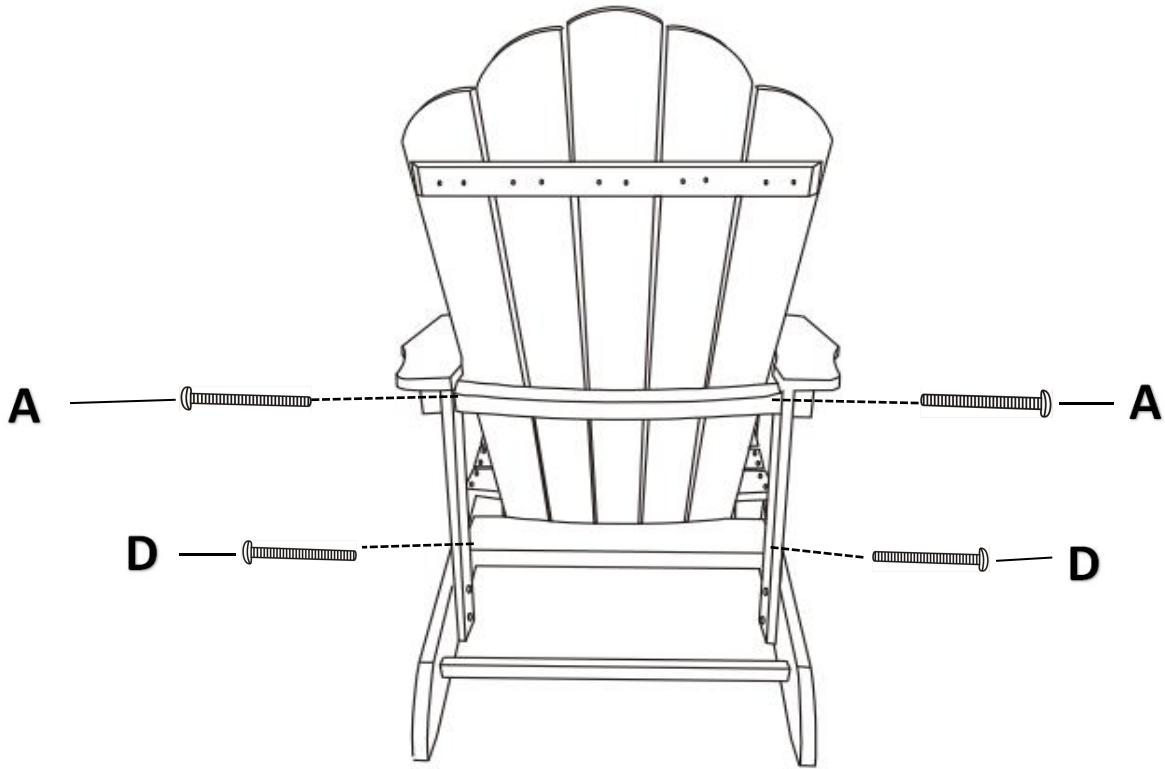

## STEP 6



# Assembly Instructions

## Poly Plastic Side Table

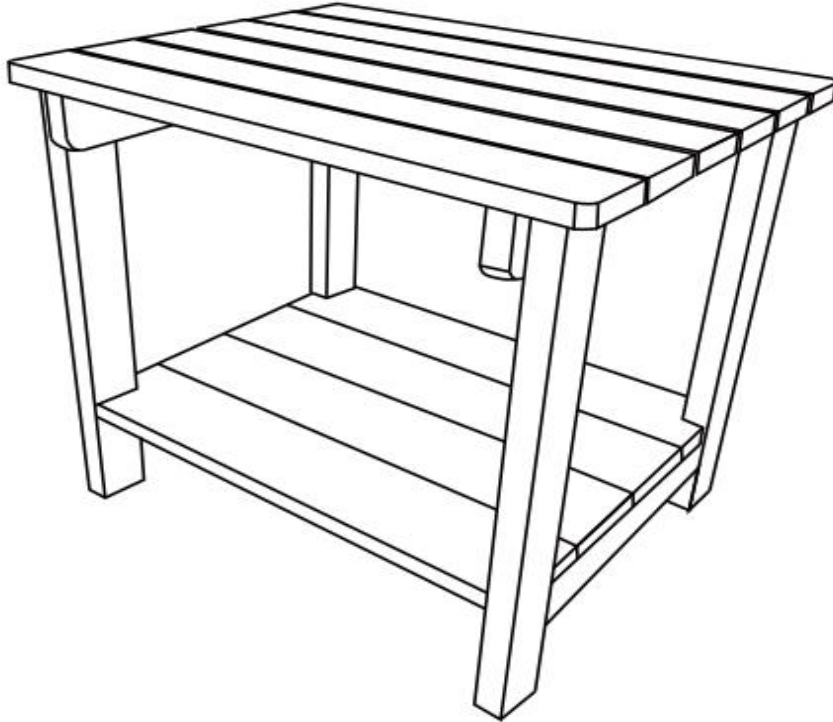

**CAUTION: This Table is NOT a TOY.**

Keep your child / children at bay during the assembly process.







For moving the Table and to prevent damages, two adults are needed to execute this action.

Please keep this instruction manual for future reference.

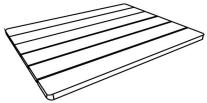
### Side Table Installation and Maintenance

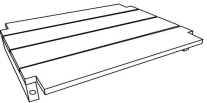
1. Do not fully tighten all bolts until all parts are in place. Failure to follow these instructions may cause the bolts to misalign during assembly
2. Please keep away from extreme heat and strong oxidizing agents
3. Under the sun, there is no need to cover the table with an airtight dust cover, as the high temperature will deform the material
4. In an outdoor environment, the table does not require any protection, No need to paint or stain, and only need to wash with soap, water and soft bristle brush or sanding sponge
5. Children should not climb or jump on the table

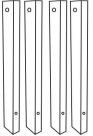
# Pre-Assembly

Part list								
Label	Description		Qty		Label	Description		Qty
①		Table top	1 pc		A		Bolt M6*65MM	4 pcs
②		Shelf board	1 pc		B		Bolt M6*55MM	4 pcs
③		Table legs	4 pcs		C		M6 Self-locking Nut	4 pcs
					D		Spanner	1 pc



- Read instructions, cover to cover-



- Have 2 adults on hand for assembly-



- Do not assemble on flooring or carpet-



- Assemble on a clean non-marring surface (packing foam)-



- Save all packaging until finished-

Before assembling, please check if you have all the parts on the assembly instructions.

# Assembly Steps

## Step 1

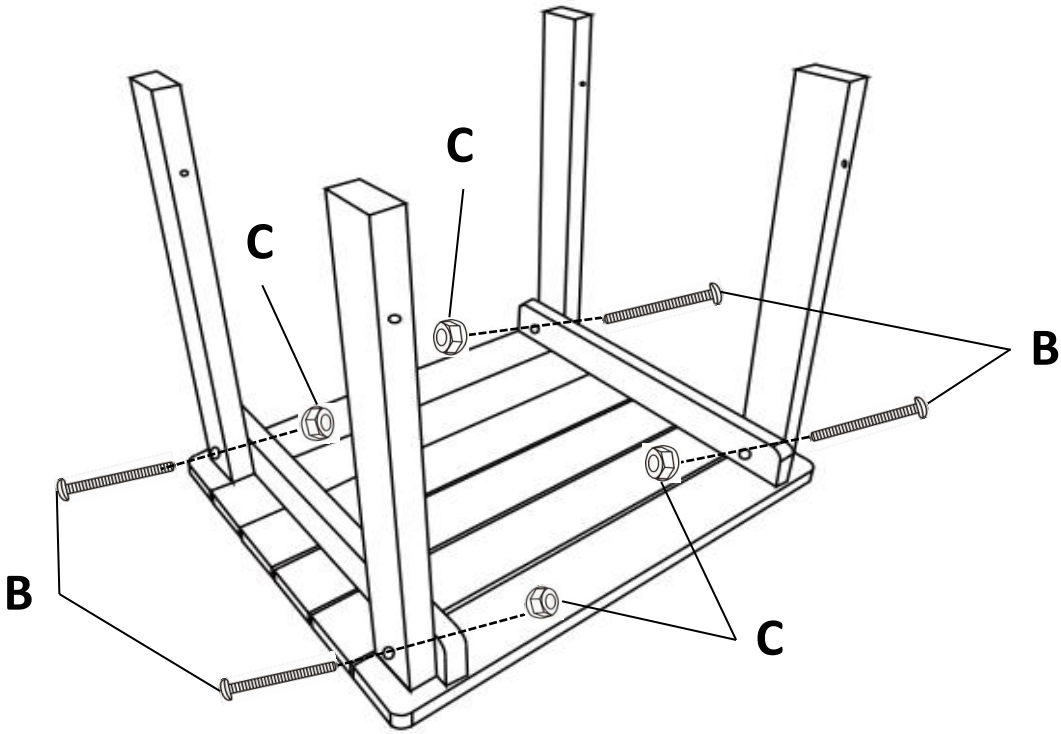

## Step 2

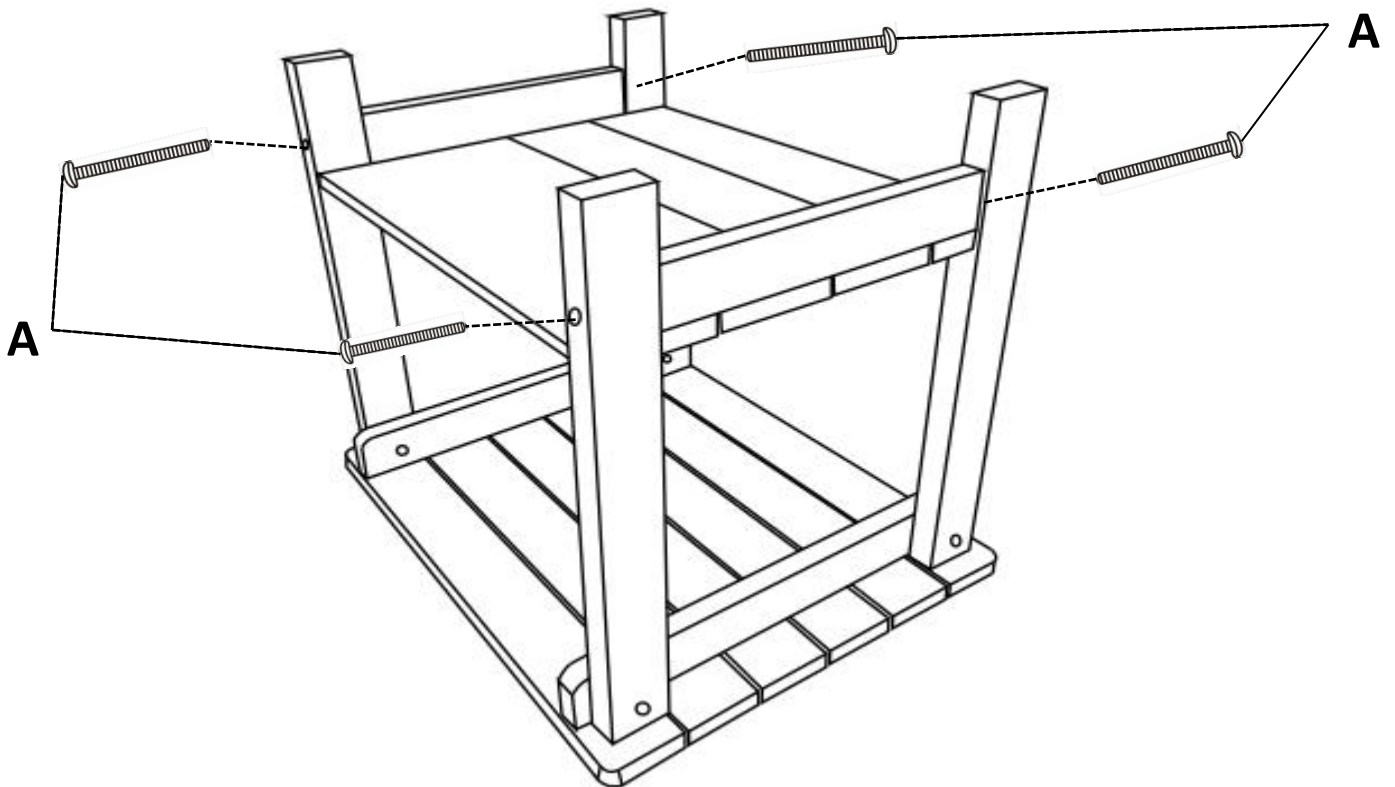



## Step 3

