























ASSEMBLY INSTRUCTION



ITEM : ABBIE DAYBED

NO	PARTLIST	QTY
1	 BACK REST	1PC
2	 LEFT ARM	1PC
3	 RIGHT ARM	1PC
4	 FRONT SIDE RAIL	1PC
5	 BACK SIDE RAIL	1PC
6	 LEGS	4PCS
7	 DAYBED SLAT 7PCS	2 SETS
8	 TRUNDLE FRONT RAIL	1PC
9	 TRUNDLE BACK RAIL	1PC
10	 TRUNDLE SIDE RAIL	2PCS
11	 SUPPORT SLAT	3PCS
12	 TRUNDLE SLAT 5PCS	2 SETS
13	 CASTORS	6PCS

NO	HARDWARE LIST	QTY
A	 JCBC SCREW M8 x 20mm	16PCS
B	 JCBC SCREW M6 x 50mm	20PCS
C	 SPRING WASHER	16PCS
D	 FLAT WASHER (big)	4PCS
E	 FLAT WASHER (small)	12PCS
F	 SCREW M4 x 32mm	16PCS
G	 SCREW M4 x 16mm	24PCS
H	 L - KEY M4 x 100mm	1PC
I	 L - KEY M5 x 65mm	1PC

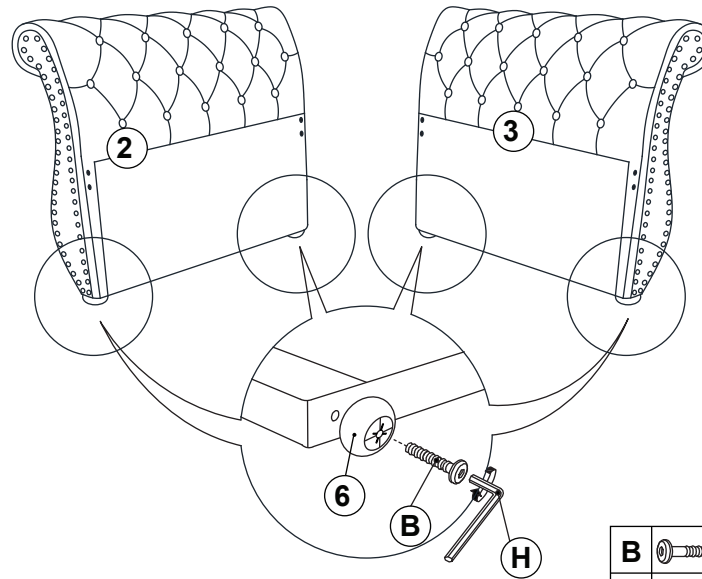

STEP 1



B		4PCS
H		1PC

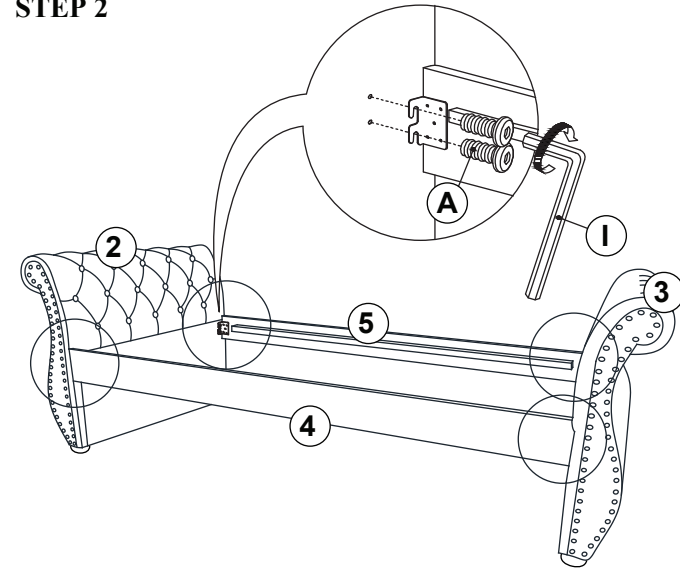



STEP 2

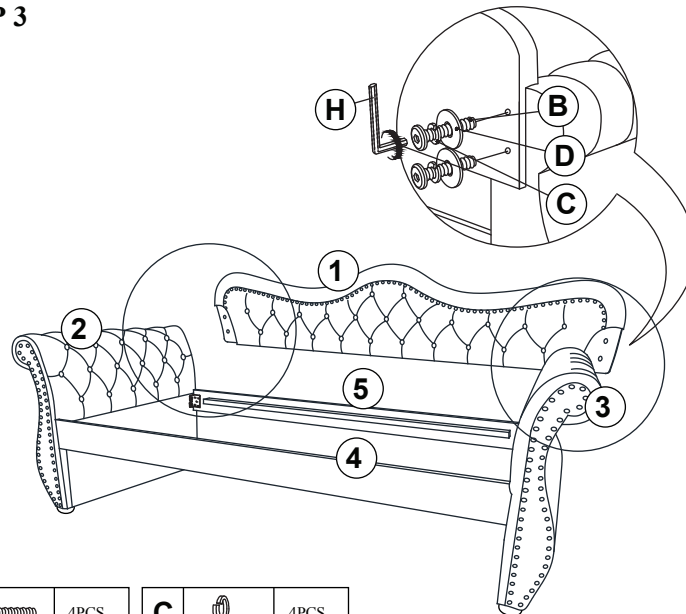

A		8PCS
I		1PC

STEP 3



B		4PCS	C		4PCS
H		1PC	D		4PCS

STEP 4

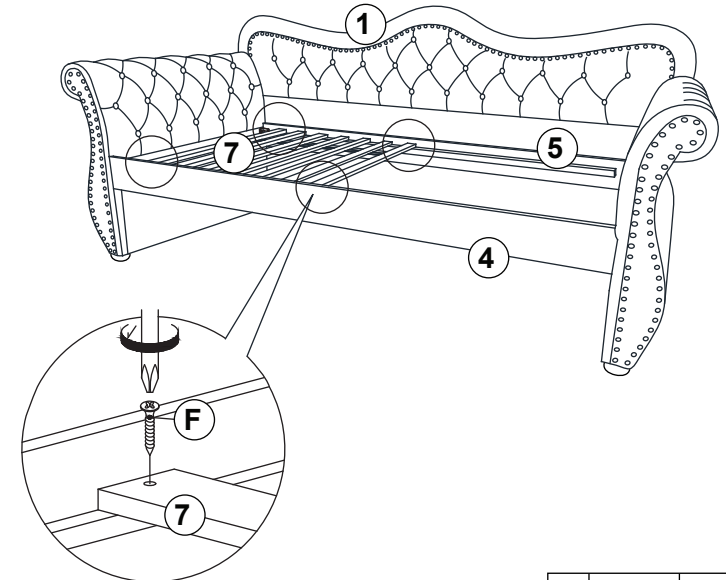

F		8PCS
----------	---	------

ASSEMBLY INSTRUCTION

STEP 5

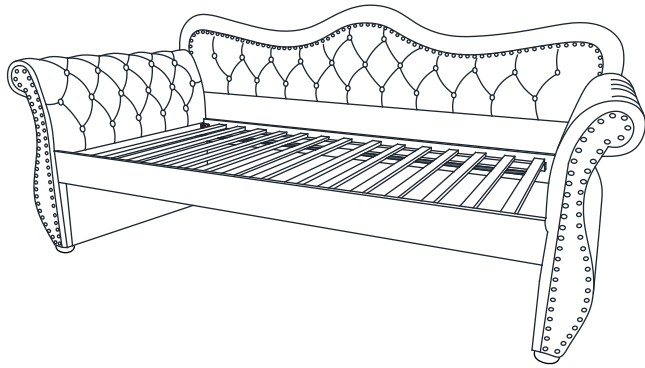

STEP 6

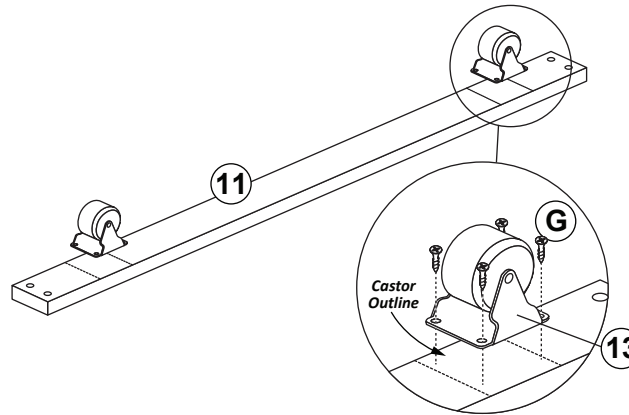

G		24PCS
----------	--	-------

STEP 7

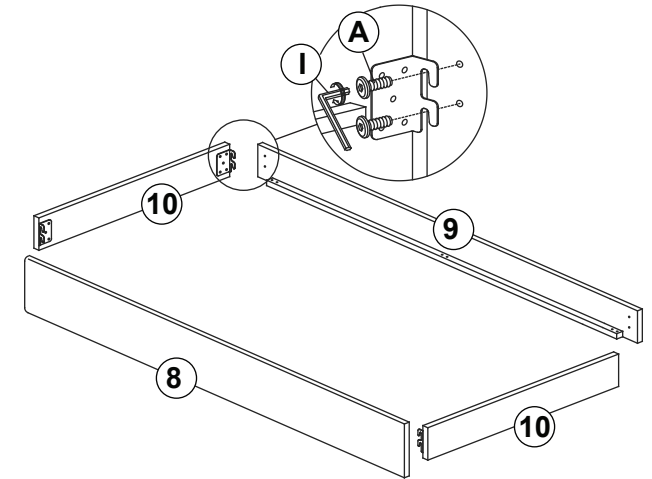

A		8PCS
I		1PC

STEP 8

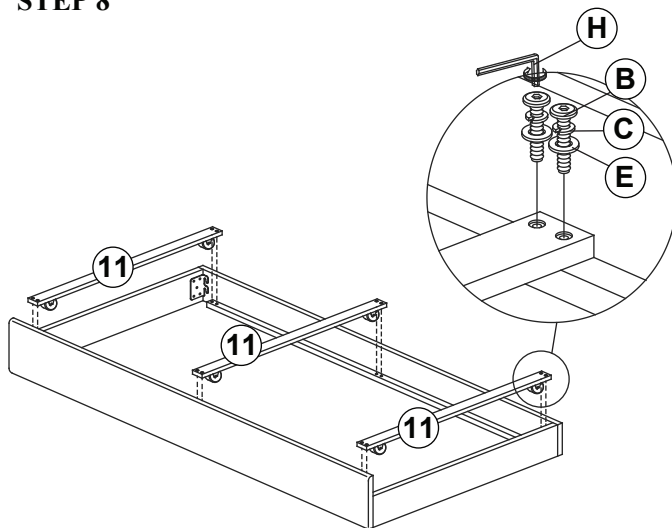

B		12PCS	C		12PCS
H		1PC	E		12PCS

STEP 9

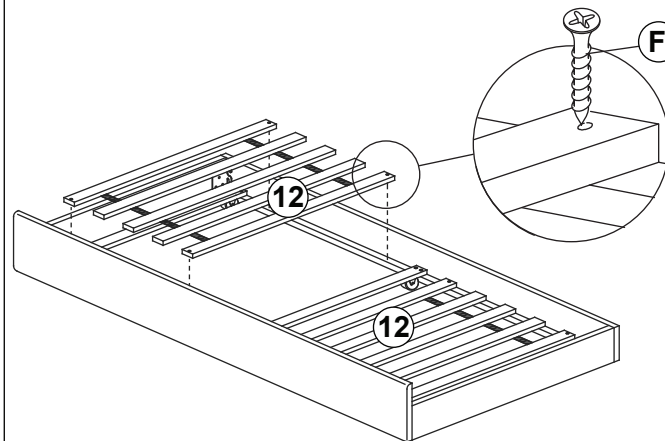

F		8PCS
----------	--	------

STEP 10

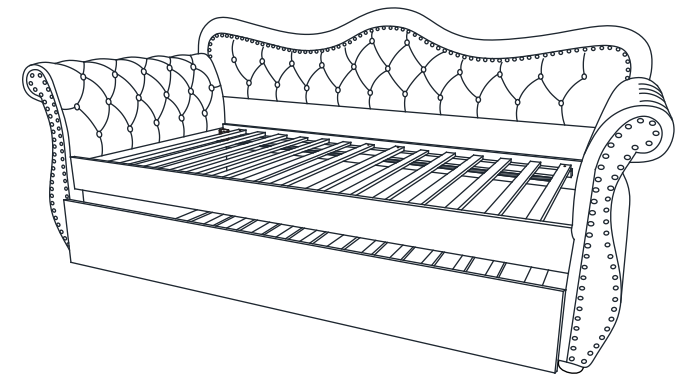

ASSEMBLY
COMPLETED