

EXPANDABLE HOME OFFICE DESK

# MODEL RTA-988D

## ASSEMBLY INSTRUCTIONS

REV.CAR-7484-0723

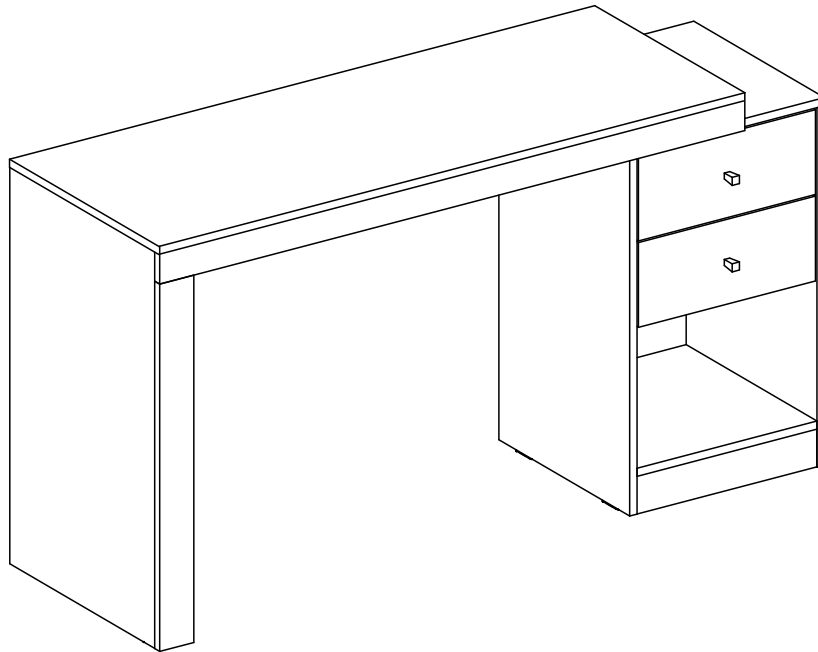

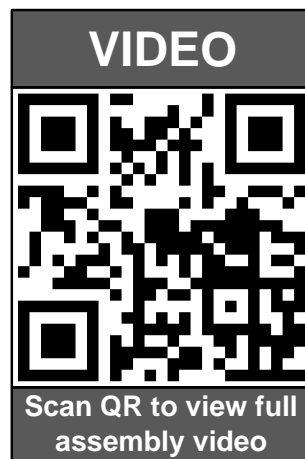

Thank you for purchasing our product



<p>Do a quick inventory of all the parts and hardware listed below.</p> 	<p><b>For Support, assembly questions &amp; Replacement Parts within the 48 Contiguous United States:</b></p> <p>Please email us at: <a href="mailto:support@rtaproducts.com">support@rtaproducts.com</a></p> 	<p>Replacement Parts for International Customers &amp; <b>AK-HI-PR</b> orders: RTA Products will replace the part free of charge, while <b>the customer is responsible for shipping costs plus any International local taxes or duties.</b></p>
---	---	---

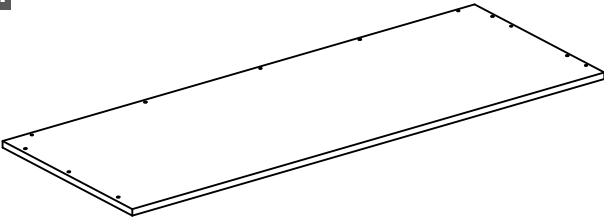
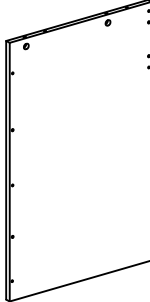
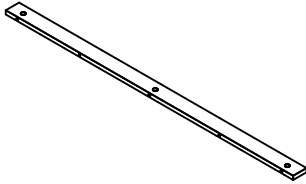
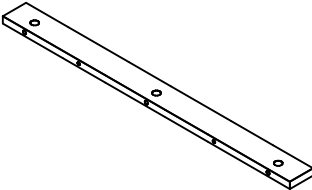
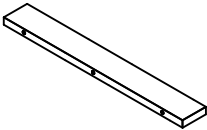
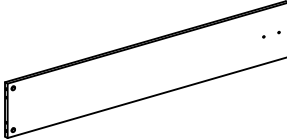
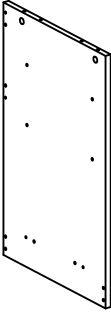
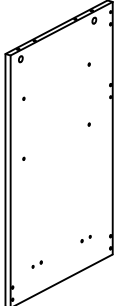
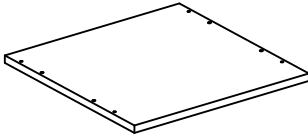
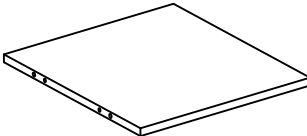

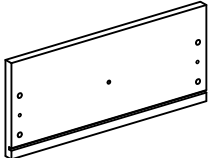
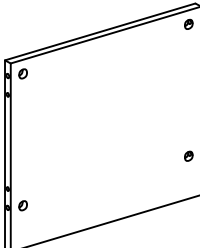
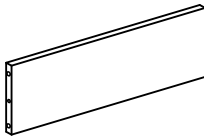
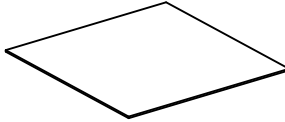
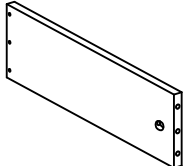

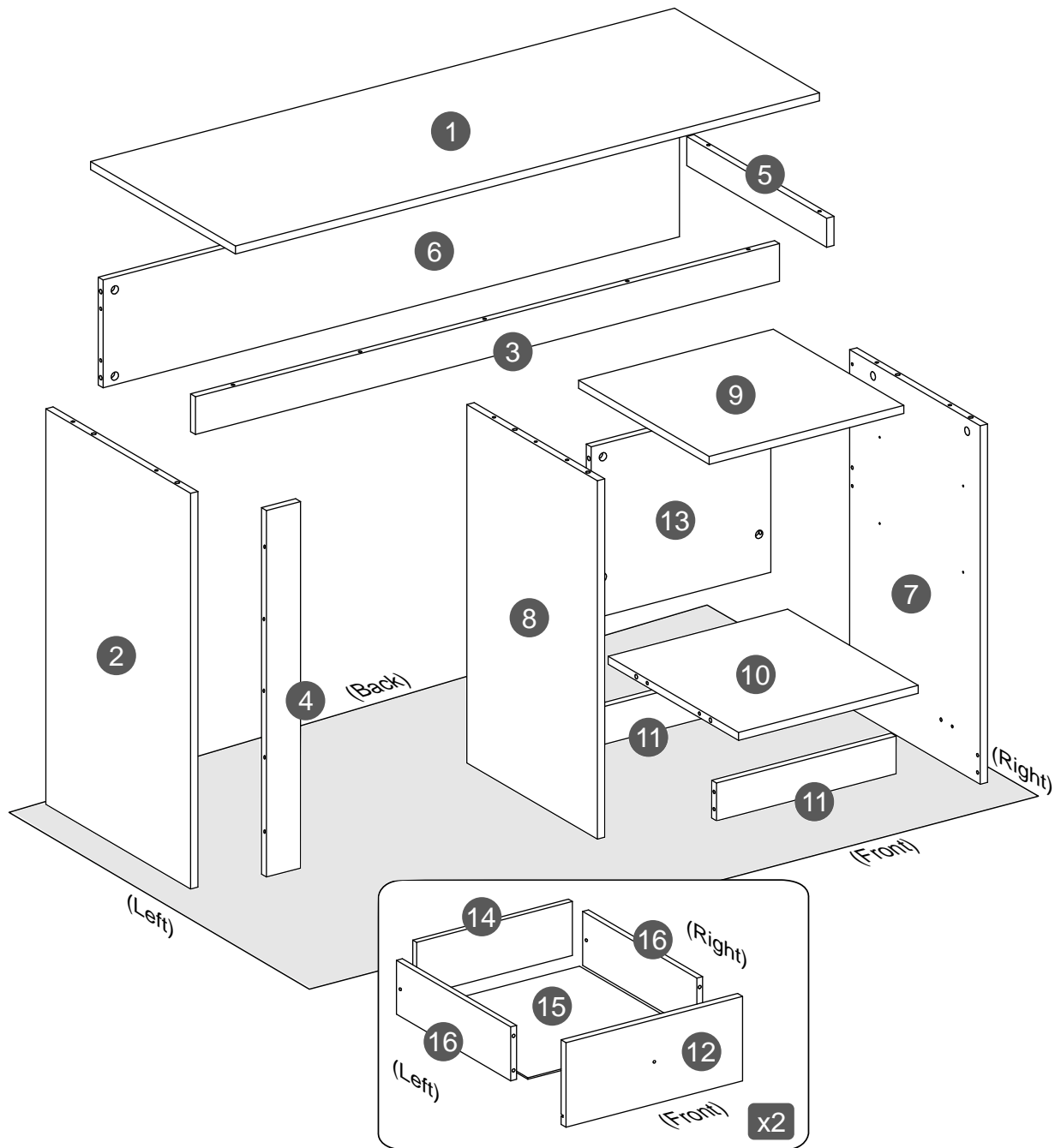

## MAIN PARTS LIST

<p><b>1</b> Tabletop (main panel) <b>x1</b></p> 	<p><b>2</b> Left side panel <b>x1</b></p> 	<p><b>3</b> Top front panel <b>x1</b></p> 
<p><b>4</b> Left front panel <b>x1</b></p> 	<p><b>5</b> Right-top side panel <b>x1</b></p> 	<p><b>6</b> Top-back panel <b>x1</b></p> 
<p><b>7</b> Right side panel <b>x1</b></p> 	<p><b>8</b> Middle side panel <b>x1</b></p> 	<p><b>9</b> Cabinet top panel <b>x1</b></p> 
<p><b>10</b> Cabinet bottom panel <b>x1</b></p> 	<p><b>11</b> Cabinet skirt panel <b>x2</b></p> 	<p><b>12</b> Drawer front panel <b>x2</b></p> 
<p><b>13</b> Cabinet back panel <b>x1</b></p> 	<p><b>14</b> Drawer back panel <b>x2</b></p> 	<p><b>15</b> Drawer bottom board <b>x2</b></p> 
<p><b>16</b> Drawer side panel <b>x4</b></p> 		

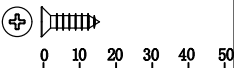
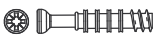
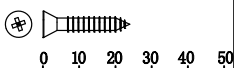
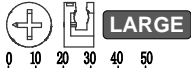
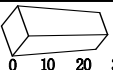
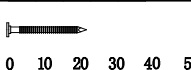

MAIN PARTS LAYOUT (For reference)

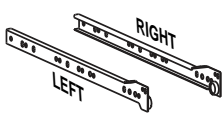
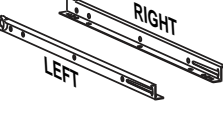
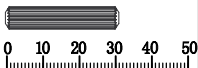
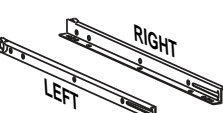
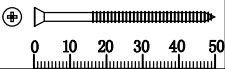

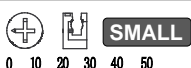
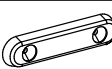
**HARDWARE LIST**

PART	QTY	SIZE	ITEM	PART	QTY	SIZE	ITEM
A	42	M3.5x14		K	26	M5x30 Bolt	
B	4	M3.5x25		L	22	15x11 Cam lock	
C	2	Plastic handle 27mmx15mm		M	18	2x22 Nail	
D	4	Large metal bracket		N	8	Hole cover sticker	
E	2	Small metal bracket		O	2 Sets	Metal sliders, Set of 4 pcs	 <p>"FLAT": 2 pcs per set, go inside the cabinet</p>  <p>"L shape": 2 pcs per set, go on the drawers</p>
F	1	Flat metal bracket					
G	47	M6x30 Wooden dowel					
H	4	M4x50					
I	8	M6x10 Euro screw		P	4	12x9 Cam lock	
J	6	Plastic glide foot					

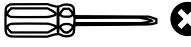
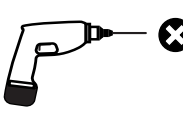
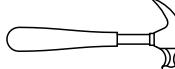
**TOOLS THAT ARE REQUIRED (NOT INCLUDED WITH THE PRODUCT)**

1	Phillips Screwdriver or Power drill with Phillips bit	 	1	Hammer	
			1	Pencil	

If you will use a power driver:

- Make sure to have the appropriate Phillips bits.
- Start using at a low torque or speed to avoid stripping the screws.

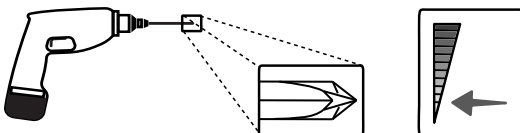

**BEFORE YOU START THE ASSEMBLY, PLEASE READ THE FOLLOWING TIPS AND WARNINGS.**

- Do not discard this manual or any of the packaging material until the unit is completely assembled.
- Please read the assembly instructions thoroughly and follow step by step.



- The assembly might require of 2 persons for certain steps. Before you start the installation, make sure there is someone else nearby to help you.



- Make sure you understand which hardware will be used on each step. Using the wrong size of screw, bolt or pin might strip the threads or cause damage to the part in which it is being used.

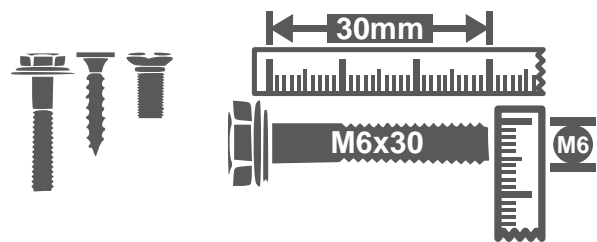

- To avoid misalignments, always leave the screws loosely and do not tighten them until all the pieces are positioned correctly.

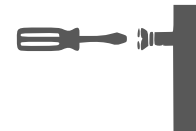

- Do not overtighten or force the screws as they might break, strip, damage the threads of the holes, or get stuck inside the parts.

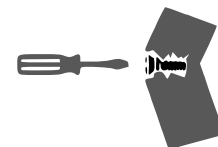

- If the hole seems too small for the screw, make sure you are using the correct size of screw and/or that you are installing it in the correct hole.



- Sometimes on the wood panels the laminate or material might be covering the hole partially or entirely, if there is no visible hole or if it looks too small, pass and press the tip of your finger over the area to feel its indentation, and carefully pierce the laminate to uncover the hole underneath.

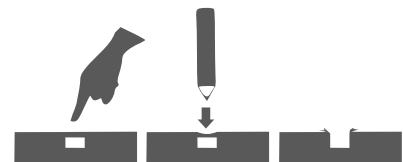

- After the item is assembled, you can use rubbing alcohol to erase or remove the visible part numbers printed or labeled on the pieces.

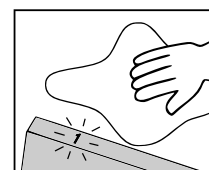

- Please be kind to our planet, when done with the assembly, recycle any of the packaging materials that is accepted by your city or recycling service.



Thank you!

**THE ASSEMBLY STEPS START ON NEXT PAGE**

**CAM BOLT AND CAM LOCK TUTORIAL**

**THE INSTRUCTIONS BELOW  
ARE NOT ACTUAL ASSEMBLY STEPS**



**This unit uses cam bolts and locks (also known as mini fixes).  
If you are not familiar with this kind of hardware, the below is a tutorial  
that explains how to use them on the steps where they are required.**

1. Screw the bolt into the indicated hole on the panel indicated in the assembly step.

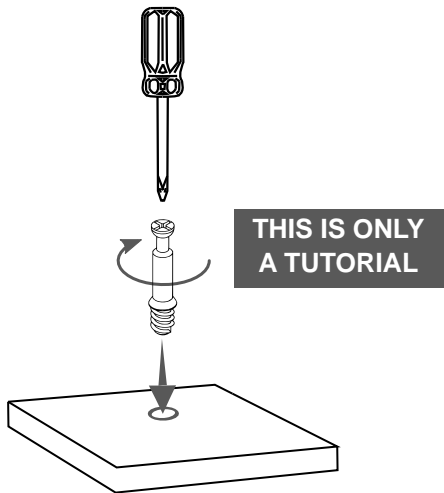

2. Join the other panel (with the big hole) to the panel with the bolt. If it comes with the cam locks already pre-installed, make sure to align them to receive the bolt's head (refer to point 3). There might be a very small gap between the panels which is normal.

If the cam locks come pre-in stalled, make sure they are aligned (see point 3).

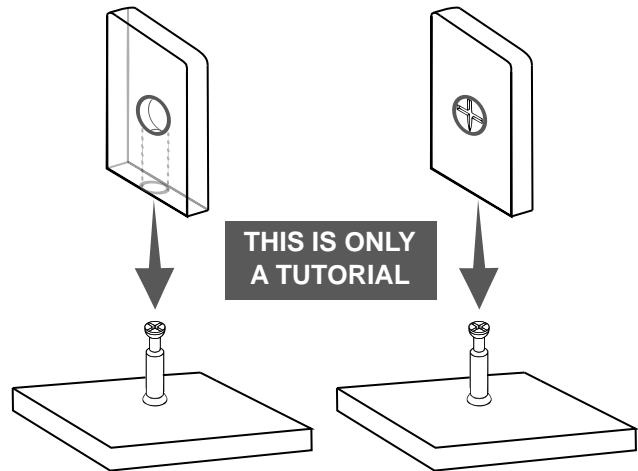

3. Insert the cam lock on the panel with the big hole making sure it goes aligned to receive the bolt's head.

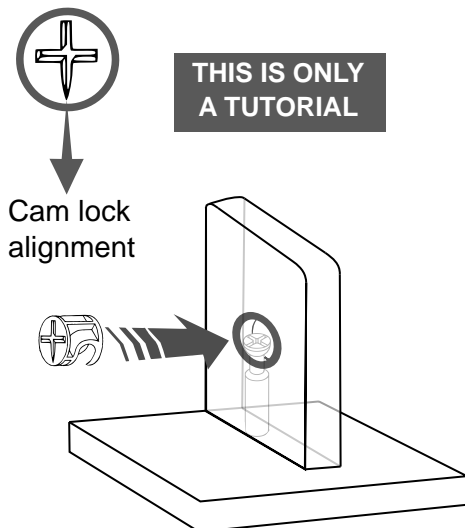

4. Use a Phillips screwdriver to turn the cam lock clockwise. This will lock the panels together and also will close any gaps.

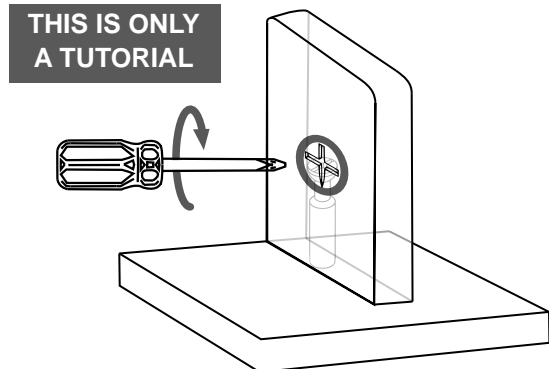

ASSEMBLY STEPS

WE RECOMMEND TO PLACE THE PIECES OVER BLANKETS TO PROTECT THEIR FINISH DURING ASSEMBLY.

STEP 1

Hardware

G

M6x30  
Wooden  
dowel

43  
Pcs

Tools (NOT included)

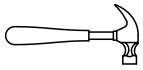

Install the wooden dowels **G** into the indicated holes on panels: **2, 3, 4, 5, 6, 7, 8, 10, 11, 13, 14** and **16**.

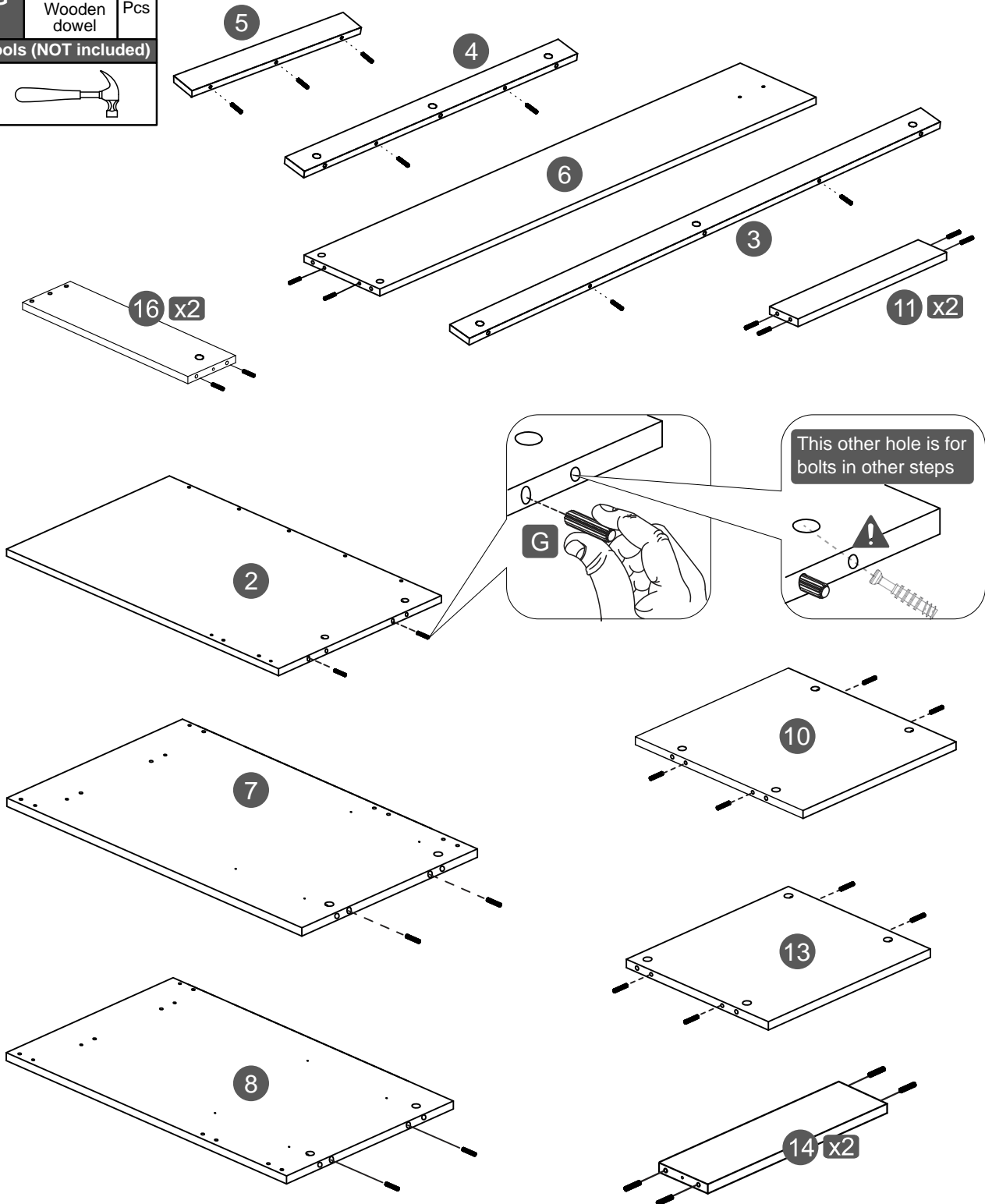

## STEP 2

### Hardware

**K**  26  
M5x30 Pcs

Tools (NOT included)

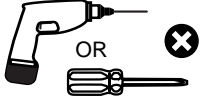

Install the bolts **K** into the indicated holes on panels **1, 2, 7, 8, 9** and **12**.

Make sure the bolts enter as straight as possible



Make sure the bolts enter all the way through its threading

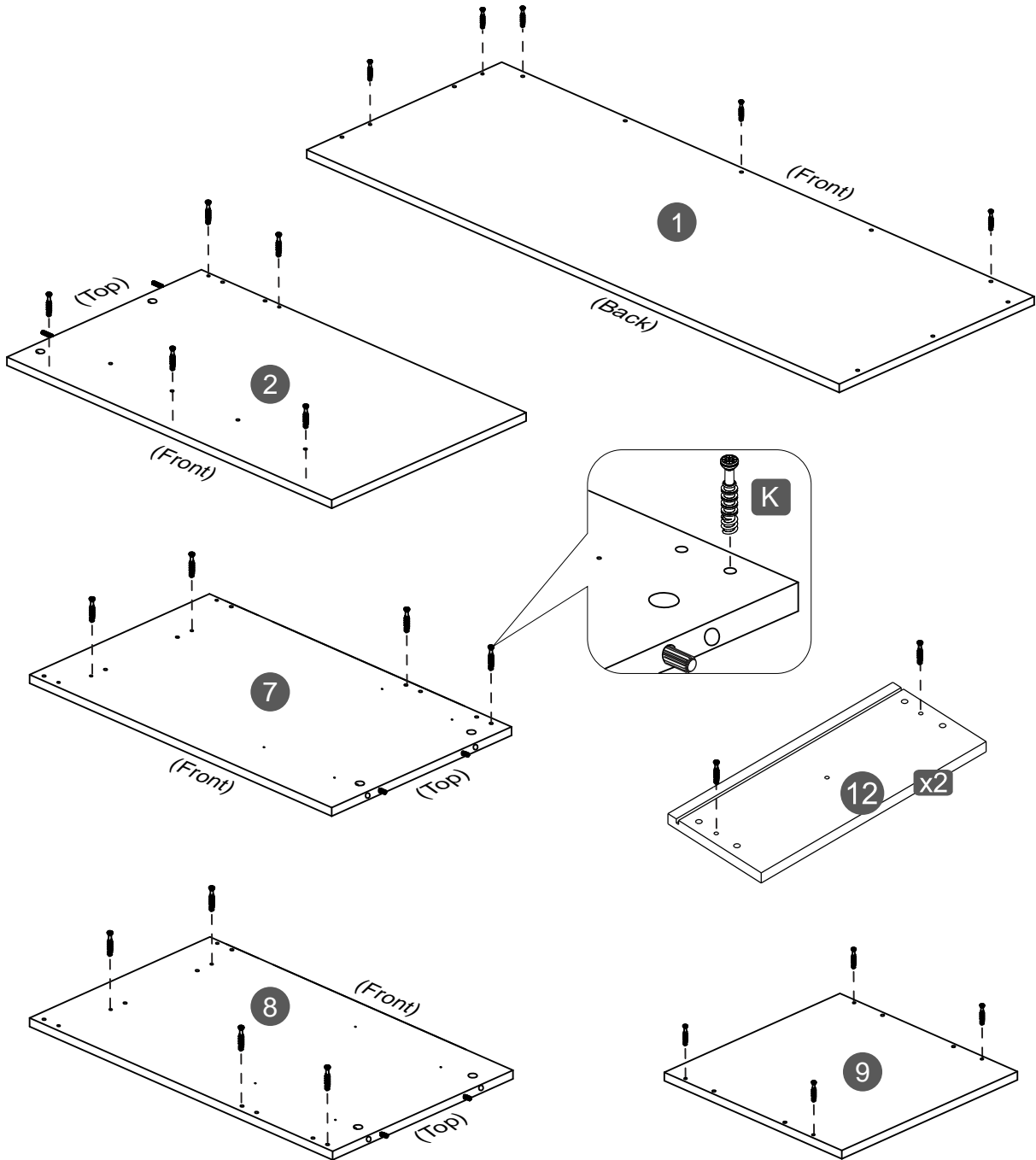



**STEP 3**

**Hardware**

2 "flat" pieces per set:



○

2 "L shape" pieces per set:



Grab both sets of sliders **O** (total 8 pieces) and separate them into 2 groups according to their shape:

- The "flat" ones will be used on the next step.
- The "L" shaped won't be used until step 9, set them aside.

○ "Flat"

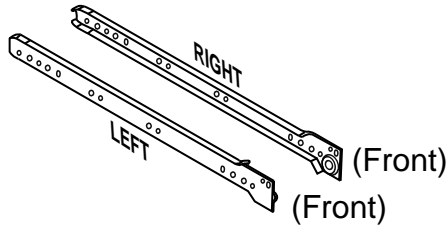

The "flat" ones will be used on the next step.

○ "L" Shaped

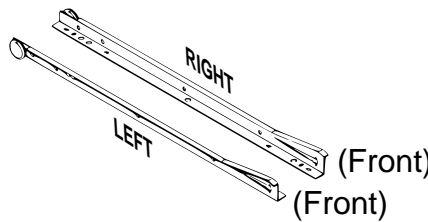

The "L" shaped won't be used until step 9, set them aside.

**STEP 4**

**Hardware**

I

M6x10

8 Pcs

○

4 "flat" pieces:

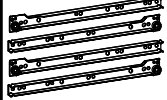

Tools (NOT included)

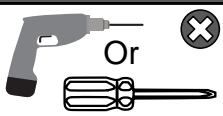

Use screws **I** to assemble the "Flat" sliders **O** to the side panels **7** and **8** in their respective sides (Right sliders to **7**, left sliders to **8**).

NOTES:

- The wheels go towards the front of the panels.
- Attach first on the front, through the **4th** hole on the slider.
- The sliders will show 2 free holes above the wheels.

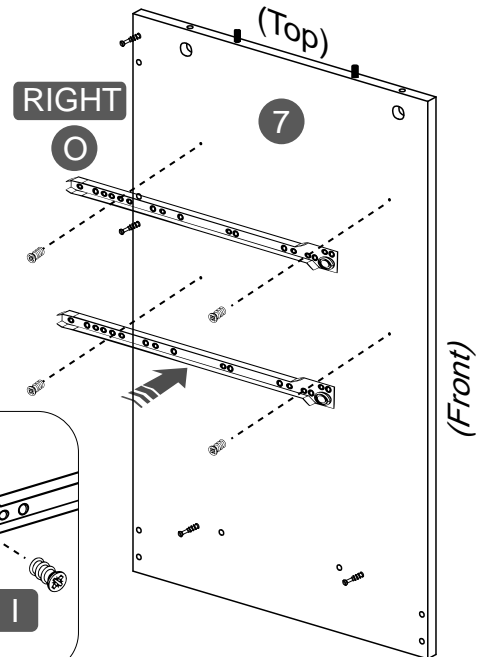
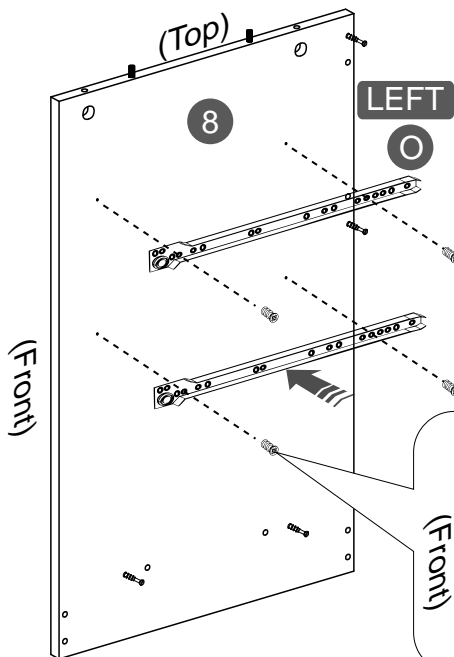
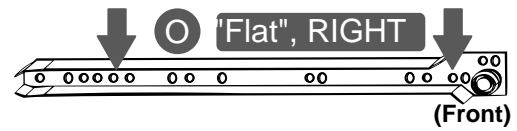
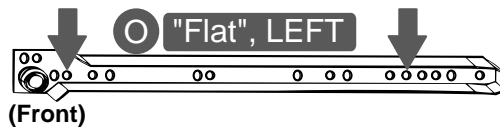

**STEP 5**

**Hardware**

**LARGE**

4 Pcs



Cam lock

**Tools (NOT included)**

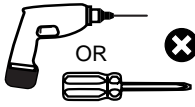

- Join the cabinet's bottom panel **10** and back panel **13** to the right side panel **7**, making sure the big holes for the cam locks go facing towards the inside and the bottom respectively.
- Insert the **LARGE** cam locks **L** into **10** and **13**, and turn them to lock the pieces together as shown and as explained in page 5.

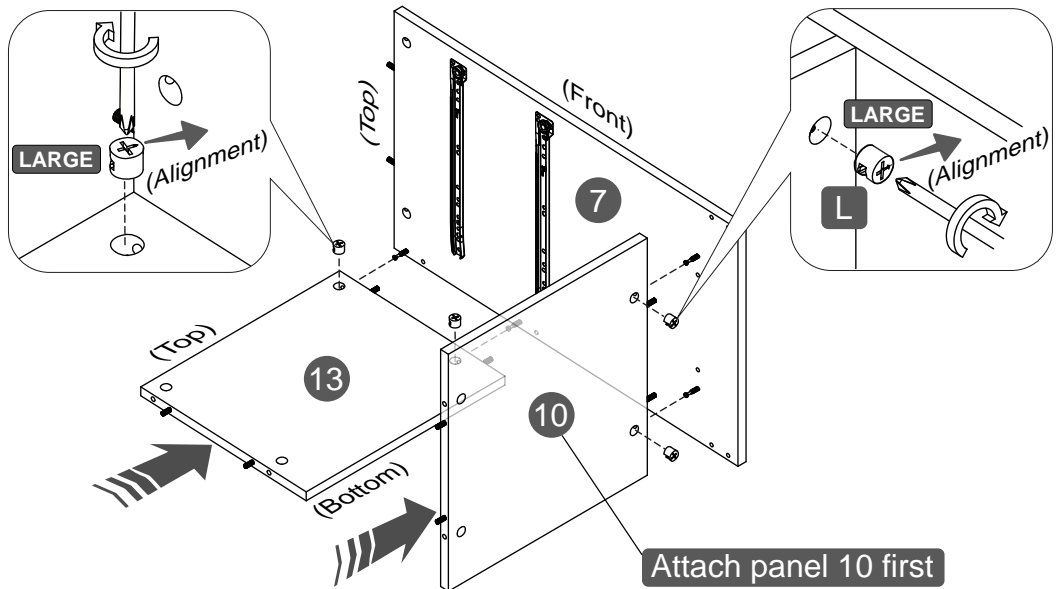

**STEP 6**

**Hardware**

**LARGE**

4 Pcs



Cam lock

**Tools (NOT included)**

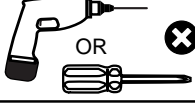

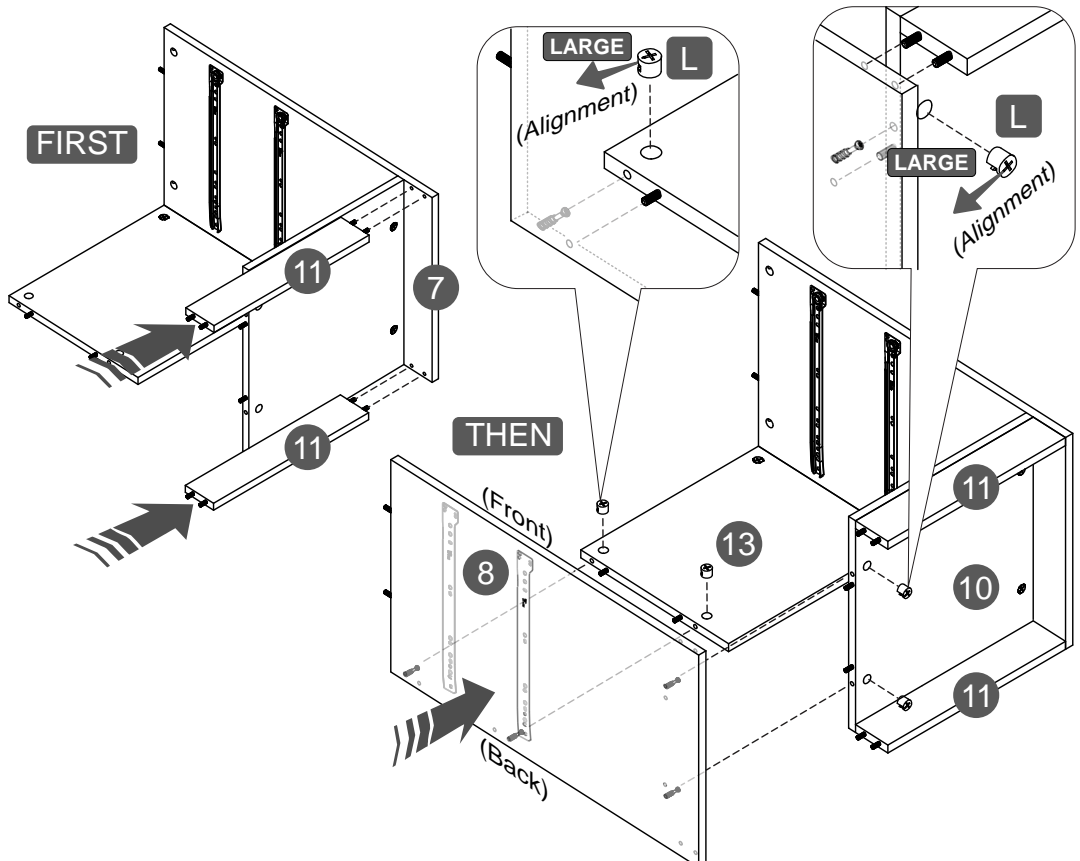

- Join the cabinet's skirt panels **11** to the right side panel **7**.
- Join the middle side panel **8** to panels **10**, **11** and **13**.
- Insert the **LARGE** cam locks **L** into **10** and **13**, and turn them to lock the pieces together as shown and as explained in page 5.



**STEP 7**

**Hardware**

<b>A</b>	 M3.5x14	8 Pcs
<b>J</b>		4 Pcs
<b>L</b>	<b>LARGE</b>  Cam lock	4 Pcs

**Tools (NOT included)**

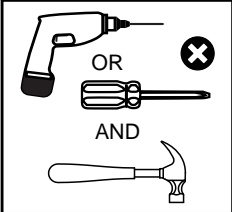



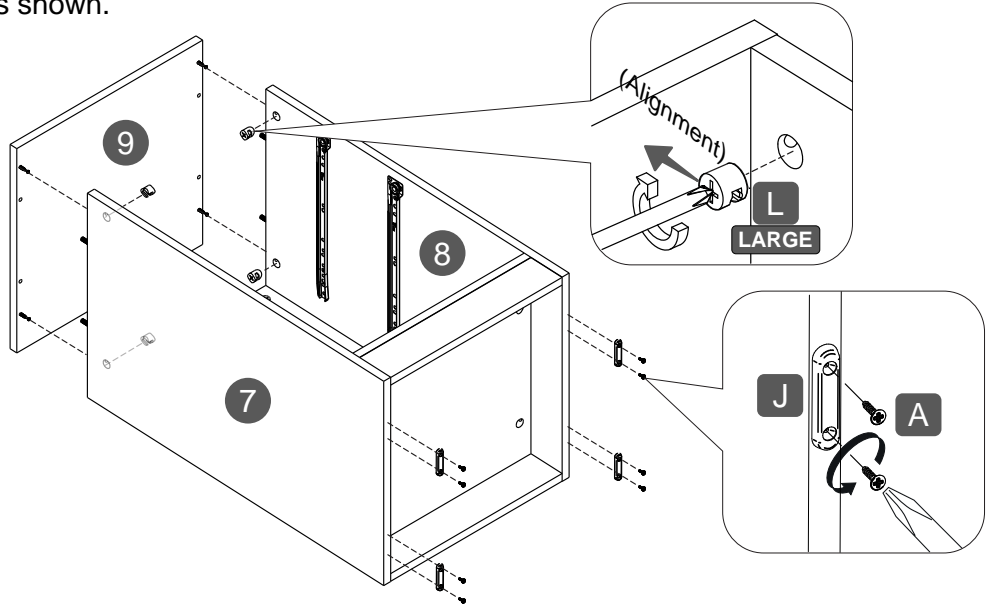

- Join the cabinet's top panel **9** to the side panels **7** and **8**.
- Insert the **LARGE** cam locks **L** into **7** and **8**, and turn them to lock the pieces together as explained in page 5.
- Attach the bottom plastic glides **J** to the bottom of panels **7** and **8** with screws **A** as shown.



**STEP 8**

**Hardware**

<b>B</b>	 M3.5x25	2 Pcs
<b>C</b>	Plastic Handle	2 Pcs
<b>H</b>	 M4x50	4 Pcs
<b>P</b>	<b>SMALL</b>  Cam lock	4 Pcs
<b>N</b>	 Cover	4 Pcs

**Tools (NOT included)**

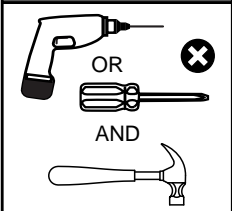

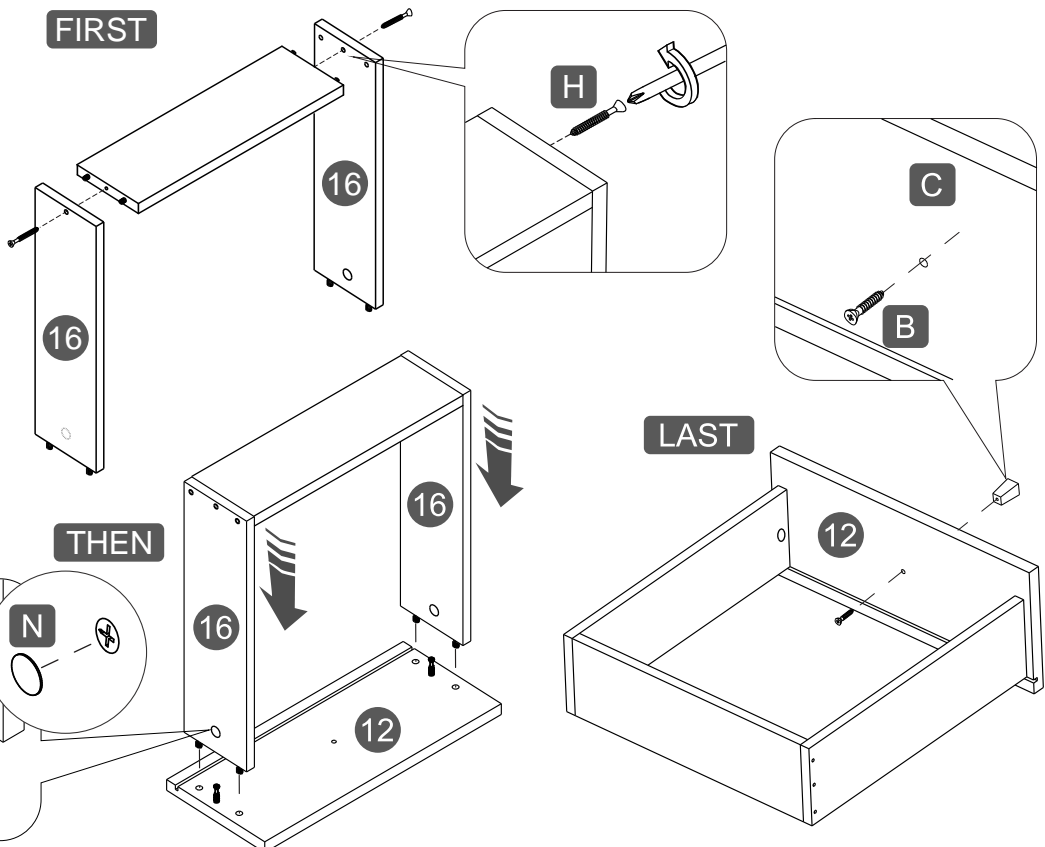

- For each of the two drawers:
- Join the side panels **16** to the back panel **14** with screws **H**.
  - Assemble the side panels **16** to the front panel **12** with **SMALL** cam locks **P** and cover them with **N**.
  - Attach the handle **C** to the front panel **12** with screws **B** as shown.



**STEP 9**

**Hardware**

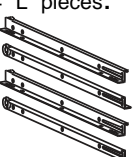
<b>A</b>	 M3.5x14	8 Pcs
<b>M</b>	 Nail	18 Pcs
<b>O</b>	4 "L" pieces: 	

**Tools (NOT included)**

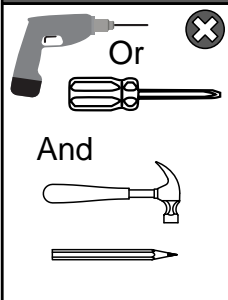

For each of the drawers:

- Flip them upside-down (the groove on the front panel **12** will face up) and place on it the drawer bottom board **15**, inserting one end into the groove of the front panel.
- Use one nail **M** to secure the bottom board to the back panel **15** as shown.
- Place the "L" shaped sliders **O** on the sides with their wheels facing towards the back, and mark the board with a pencil on the **1st** hole from each end that will be used to attach them to the drawer, and remove the sliders.
- Secure the bottom board **15** with 8 more nails **M** making sure not to block the marks where the sliders will be installed.
- Assemble the sliders **O** on their respective sides with screws **A**.

**Notes:**

- The wheels go towards the back of the drawer.
- The sliders should not protrude from the bottom of the drawer, otherwise they raise the drawer 1" more and won't fit in the unit.

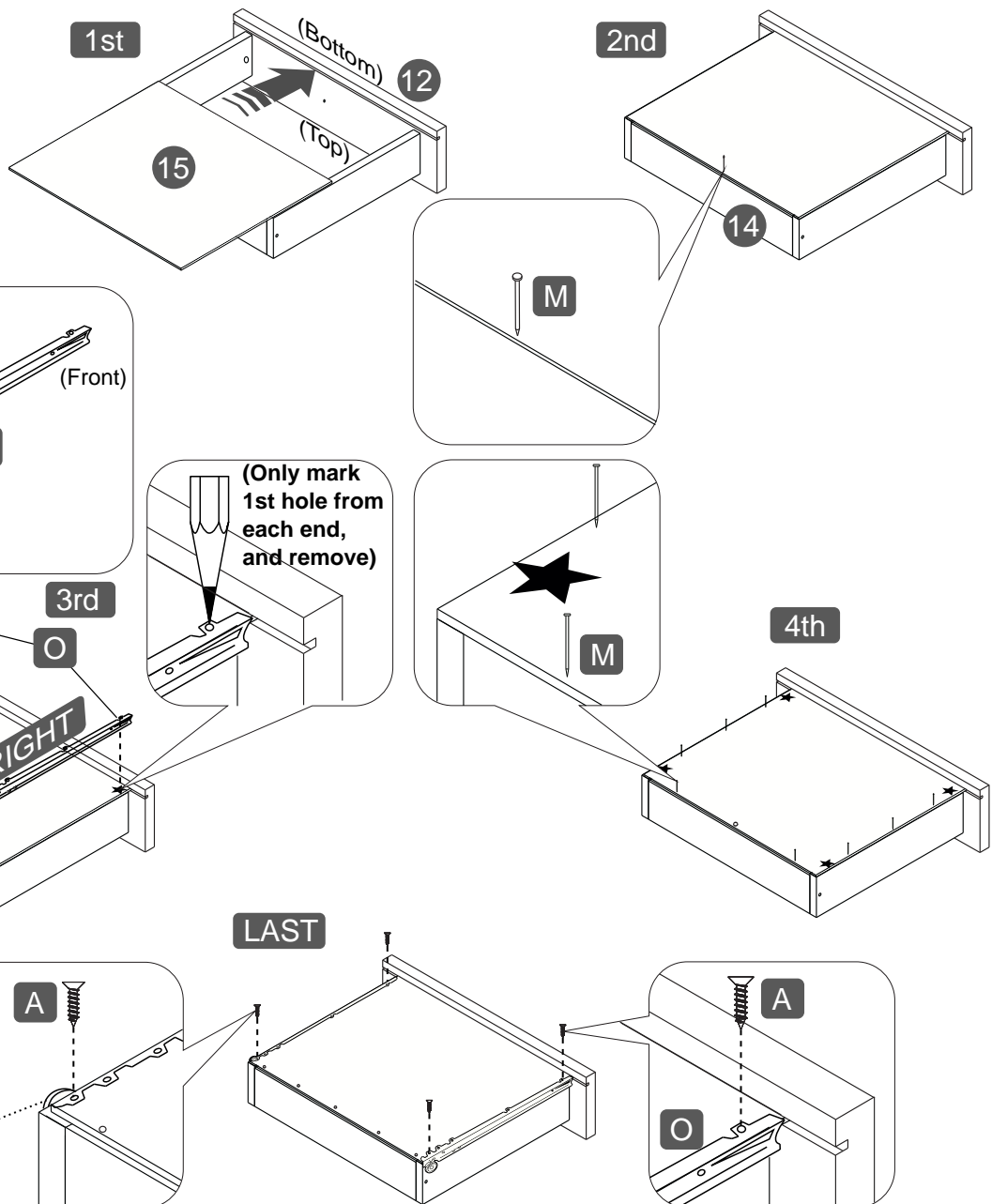

**STEP 10**

Insert the drawers into the cabinet, starting with the bottom one, and with the front facing down at an angle. If the drawers don't seem to fit, review the assembly done in steps 4 and 9.

**The wheels from the drawer must slide in the middle of the sliders, not on top on them.**

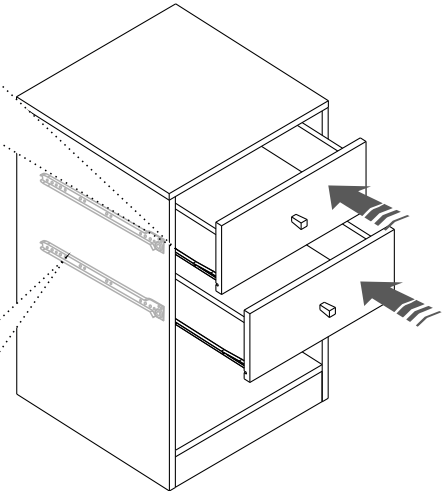
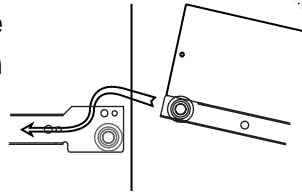

**If the drawers stop or feel like hitting something, tighten all the screws as flushed as possible so the heads don't interfere with the rollers.**

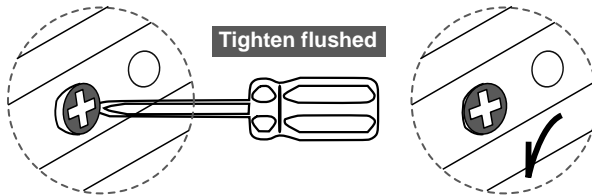

**STEP 11**

This step requires of 2 persons



**Hardware**

L	LARGE	4 Pcs
	Cam lock	
N	Cover	4 Pcs

**Tools (NOT included)**

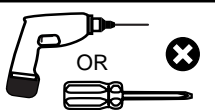

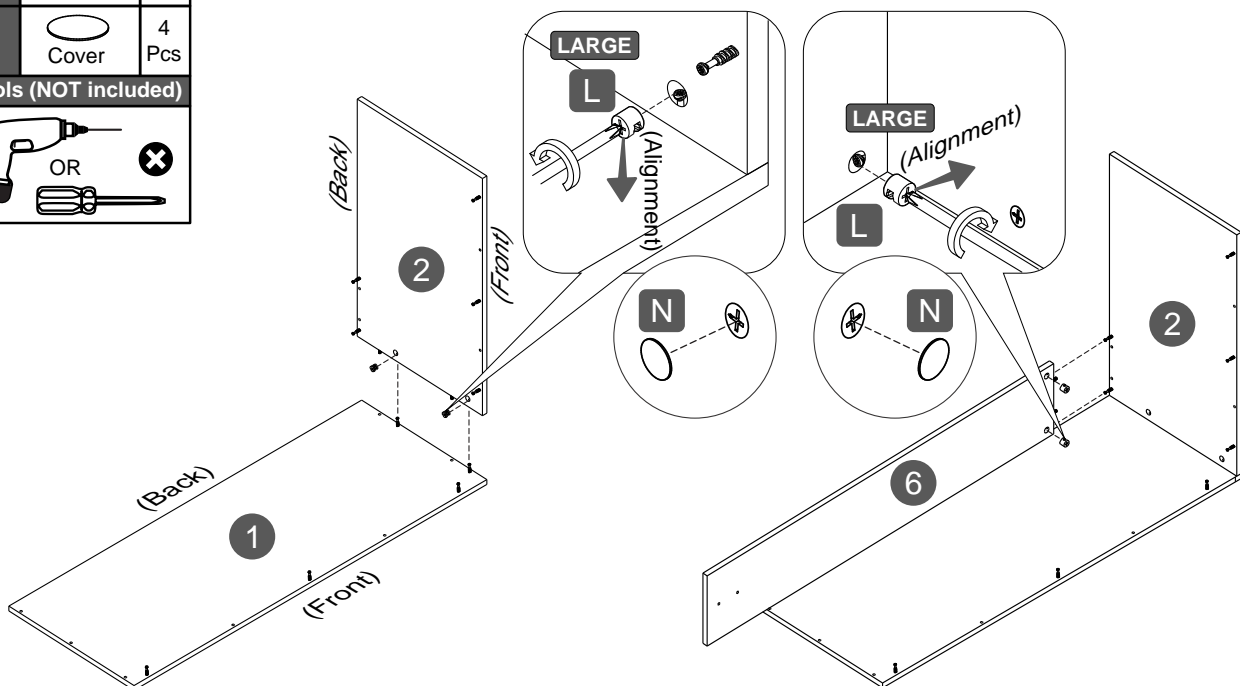

- With the help of another person, join the left side panel 2 to the tabletop 1, insert the **LARGE** cam locks L into the holes of 2, and turn them to lock the pieces as explained in page 5.
- Join the top back panel 6 to the side panel 2, insert the cam locks L into the holes of 6, and turn them to lock the pieces as explained in page 5. Cover the cam locks with stickers N.



**STEP 12**

This step requires of 2 persons 

**Hardware**

A	 M3.5x14	16 Pcs
D		3 Pcs
J		2 Pcs

Tools (NOT included)

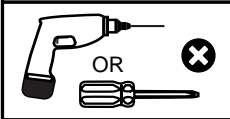

**IMPORTANT:**

- Please note that neither panel 6 or panel 1 have predrilled holes or any other markings for this step; that is the way they are manufactured.
- The assembly of panel 6 requires that it stays as still as possible, so a second person should hold it in place firmly during the assembly.

- With the help of another person holding firmly the panel 6, attach the brackets D to secure panel 6 to the tabletop 1 with screws A as shown. It is recommended to secure first at the opposite end of panel 2.
- Attach the glides J to the bottom of panel 2 with screws A as shown.

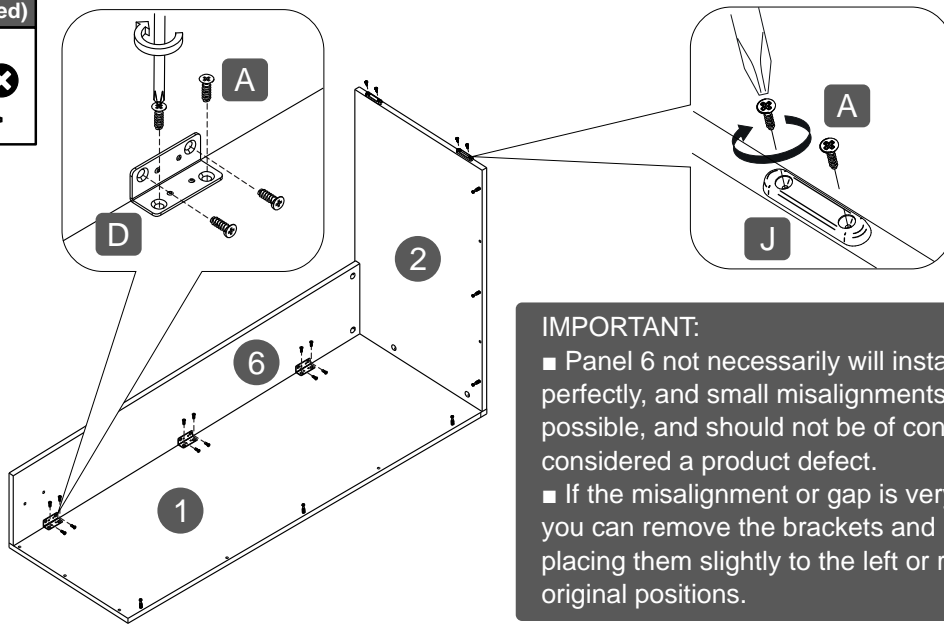

**IMPORTANT:**

- Panel 6 not necessarily will install 100% perfectly, and small misalignments and gaps are possible, and should not be of concern or considered a product defect.
- If the misalignment or gap is very noticeable, you can remove the brackets and reinstall by placing them slightly to the left or right of their original positions.

**STEP 13**

**Hardware**

L	 LARGE Cam lock	6 Pcs
---	--	-------

Tools (NOT included)

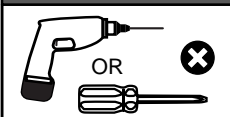

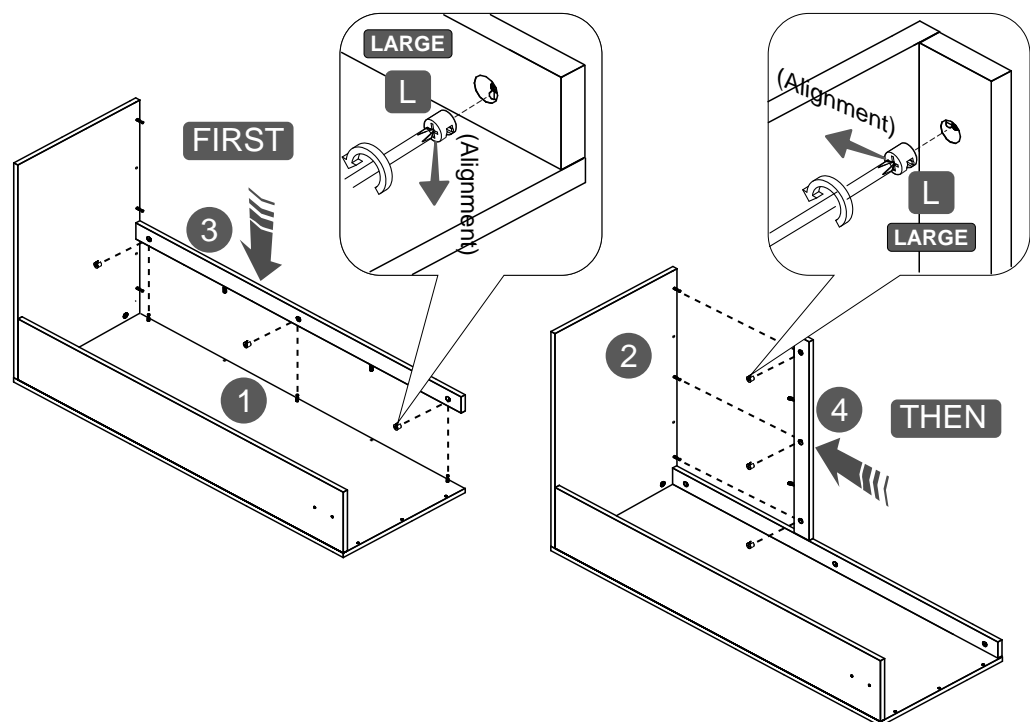

- Join panel 3 to the tabletop 1 with **LARGE** cam locks L as explained in page 5.
- Join panel 4 to panel 2 with cam locks L as explained in page 5.

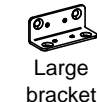

**STEP 14**

**Hardware**

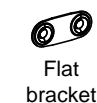
<b>A</b>	 M3.5x14	10 Pcs
<b>D</b>	 Large bracket	1 Pc
<b>E</b>	 Small bracket	2 Pcs
<b>F</b>	 Flat bracket	1 Pc

**Tools (NOT included)**

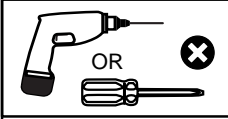

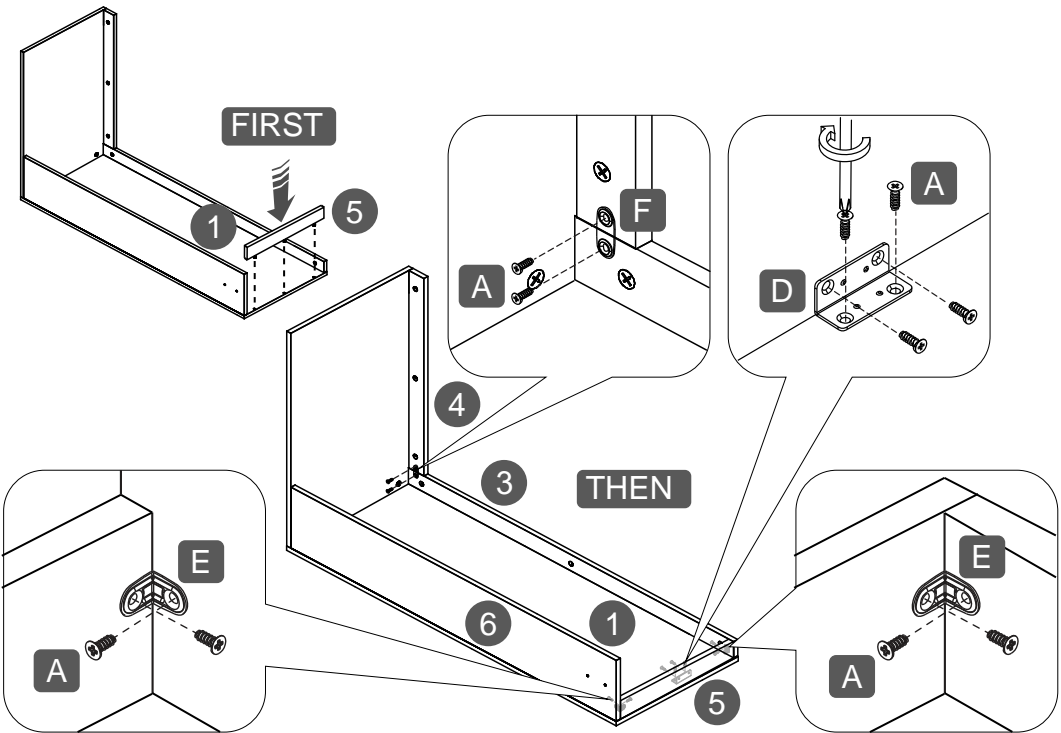

- Attach the side panel **5** to the tabletop **1**.
- Secure panel **5** to panel **1** with the large bracket **D** and screws **A**.
- Secure the panel **5** to panels **3** and **6** with small brackets **E** and screws **A**. Secure panels **3** and **4** with the flat bracket **F** and screws **A**.



**STEP 15**

This step requires of  2 persons

**Hardware**

<b>B</b>	 M3.5x25	2 Pcs
<b>N</b>		2 Pcs

**Tools (NOT included)**

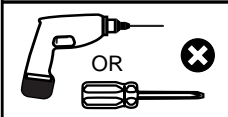

- With the help of another person, place the tabletop section over the cabinet section on the left side (item does not allow to assemble the other way), and extend to a desired width.
- **Please do not exceed the recommended maximum expansion of 10.5".**
- While the other person holds firmly the tabletop, secure the back panel **6** to the cabinet back panel **13** with screws **B** from behind.
- Cover the screw heads with stickers **N**.

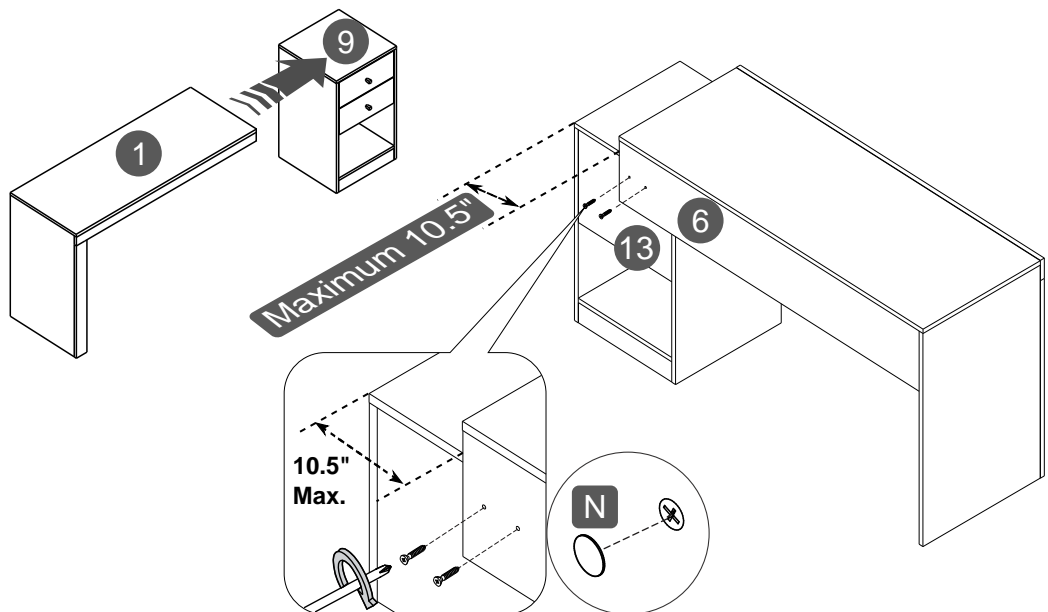

## WEIGHT LIMITS

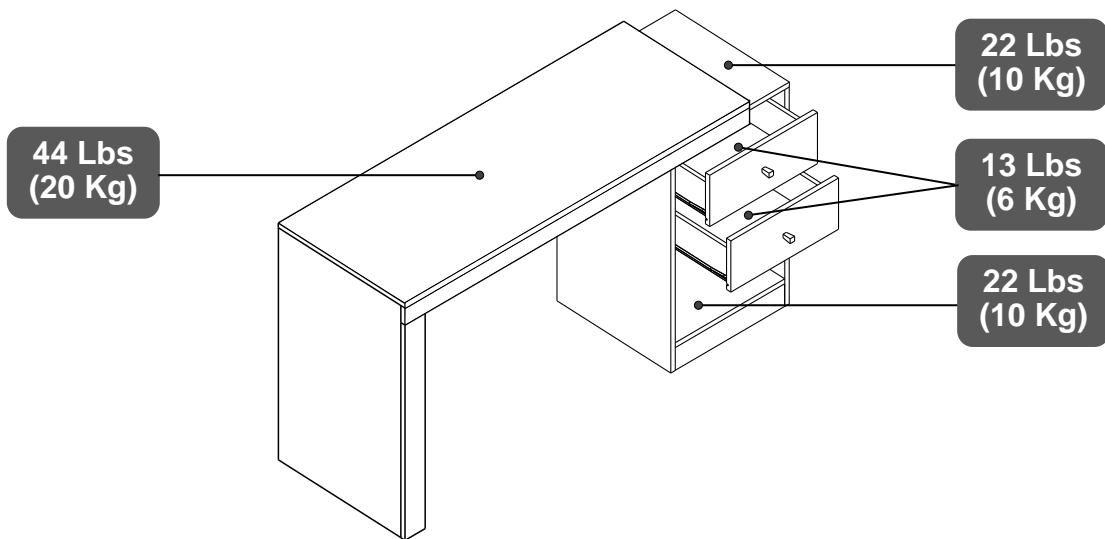

## WARNINGS

- Do not exceed the indicated weight limits.
- Do not expose the surfaces to direct sunlight or to extreme environmental conditions.
- Do not use solvents or abrasive materials to clean the unit.
- Do not sit on the unit or lean against it.
- Do not allow small children to play under or over the unit.
- Do not allow small children to reach inside the drawers or compartments without your supervision.
- Do not pull, push or drag the unit to move it for more than 1 feet. The unit must be lifted by at least 2 persons when moving in the same or adjacent rooms.
- Before moving the unit, make sure to secure or remove any object that is heavy or might fall off.
- Please note that lifting from the tabletop with too much weight on the product might lead to part damage/separation.
- When lifting the unit, use both hands and bend your knees, not your backs.

## CARE AND MAINTENANCE

- Clean the surfaces preferable with a clean cloth damped in a solution of mild soap and water, then dry with a clean towel.
- If you decide to use a cleaning agent, test first on an area hidden from view such as underneath the tabletop.
- Every 4 months, inspect the unit completely and make sure that all screws are tighten.
- When transporting the unit to places far away, protect and secure the unit to avoid damage in transit.
- Shall any part of the unit become defective during the warranty period, replacement parts might be available to you at no charge. Please refer to the last pages on this manual.
- The warranty does not extend to regular wear and tear, nor the manufacturer assumes liability for damages or consequences due to accidents, incorrect assembly, negligence, improper use, modifications, or not heeding the above warnings.



## TECHNI MOBILI WARRANTY

**DESKS/LAPTOP CARTS/FILE CABINETS: LIMITED 5-YEAR WARRANTY**

RTA Products, LLC warrants to the Original Purchaser who acquired a new product from RTA Products or its authorized resellers that this product will be free from defects in its workmanship and materials, under normal use and service conditions, as described herein. "Defects" as used in this warranty, is defined as any imperfections that impair the use of the furniture or product. RTA Products LLC will replace any defective part, at its discretion, and without charge to the original purchaser other than the freight from the end consumer to RTA Products.

Replacement parts can only be supplied if parts are available. Items out of production may be unavailable. This warranty will be effective for the applicable time period beginning the date of purchase on your original sales receipt. RTA product's obligation under this warranty is limited to repairing or replacing products or parts as provided herein. This product has been designed for and is intended for office and home-office use only. This warranty is Original Purchaser's sole remedy for product defects, and this warranty does not extend to any product, or damage to any product, caused by or attributed to abuse or misuse, products used for commercial or rental purposes, use modifications of, or attachments to the product, and products or parts not used, maintained, or extended hereunder is in lieu of any and all other warranties, express or implied, including without limitations any implied warranty or merchantability or of fitness for a particular purpose. Please note, all desks made with PVC Laminate surface should not be exposed to direct sunlight, as it may damage the material. Damage of this nature is not covered under this warranty.

RTA Products will not be responsible for indirect, special, incidental or consequential damages. This warranty is limited to merchandise purchased in the Continental United States, excludes AK, HI and PR. Some States do not allow the exclusion or limitation of incidental or consequential damages, so the above limitations or exclusions may not apply to you. This warranty gives you specific legal rights. You may also have other rights that may vary from state to state.

**To file a Claim within the 48 contiguous United States:**

Email us to [warranty@rtaproducts.com](mailto:warranty@rtaproducts.com) to explain the defect and provide your name, address, phone number, model number of our product, date and place, and proof of purchase. Please provide pictures of the damage or defect. If we determine that a replacement will remedy the situation, and in order to determine the extent or the cause of the defect, purchaser may be requested to send the part in question at purchaser's expense. Once we receive the part, we will examine it and determine whether the claim is valid (or not), and then proceed to send the replacement. We will ship the replacement at our expense.

**Replacement Parts for International Customers & AK-HI-PR orders:**

RTA Products will replace the part free of charge, while **the customer is responsible for shipping costs plus any International local taxes or duties.**