

# ASSEMBLY INSTRUCTION

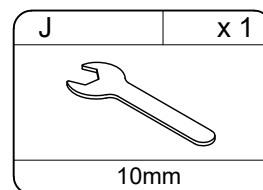

1.

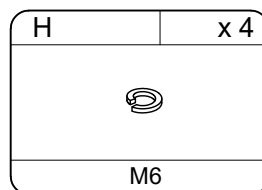
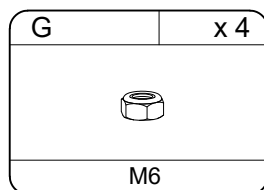
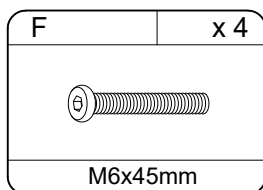
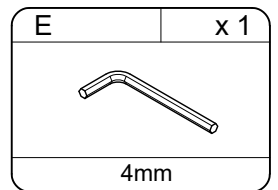
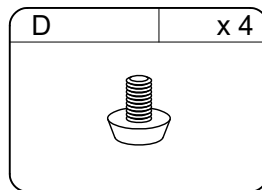
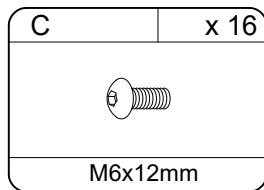
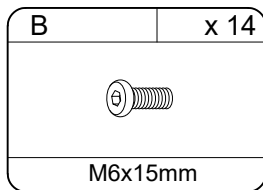
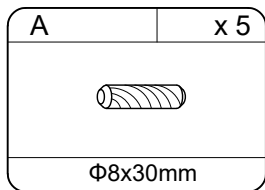
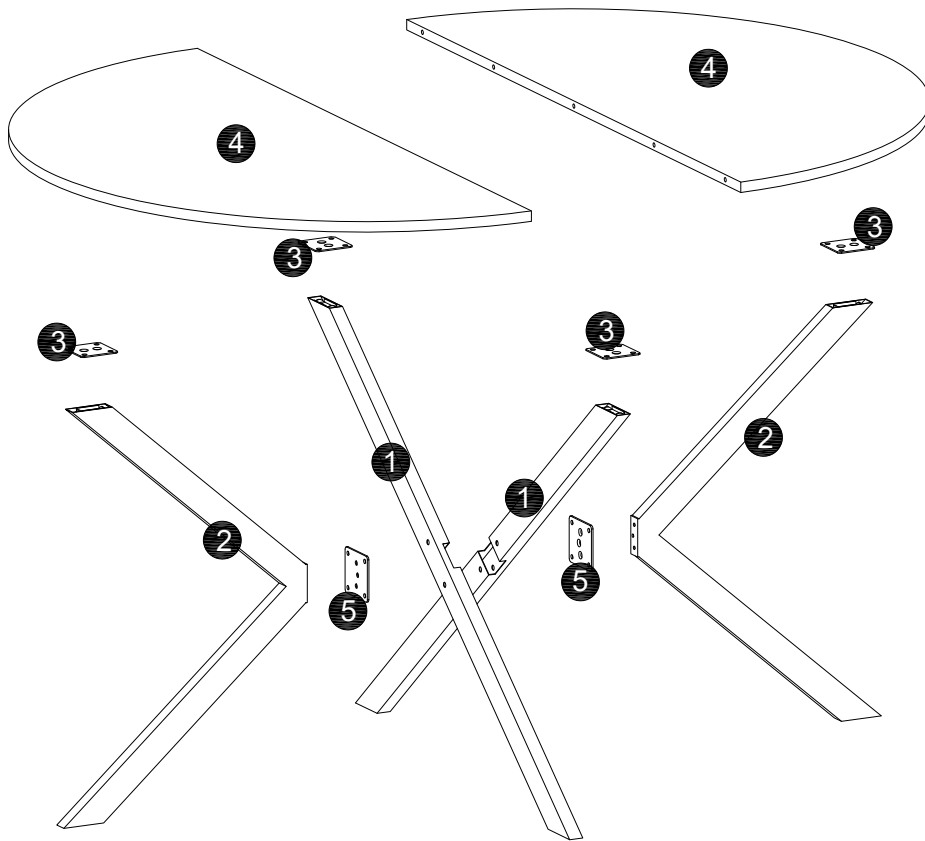
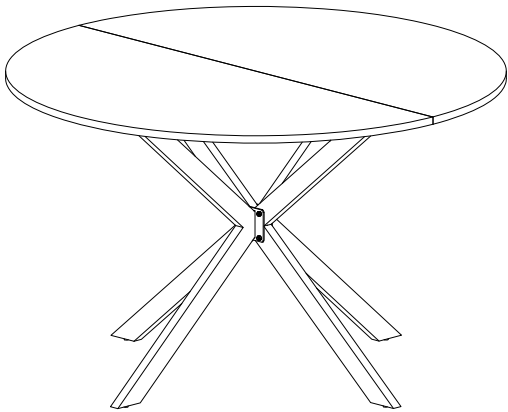
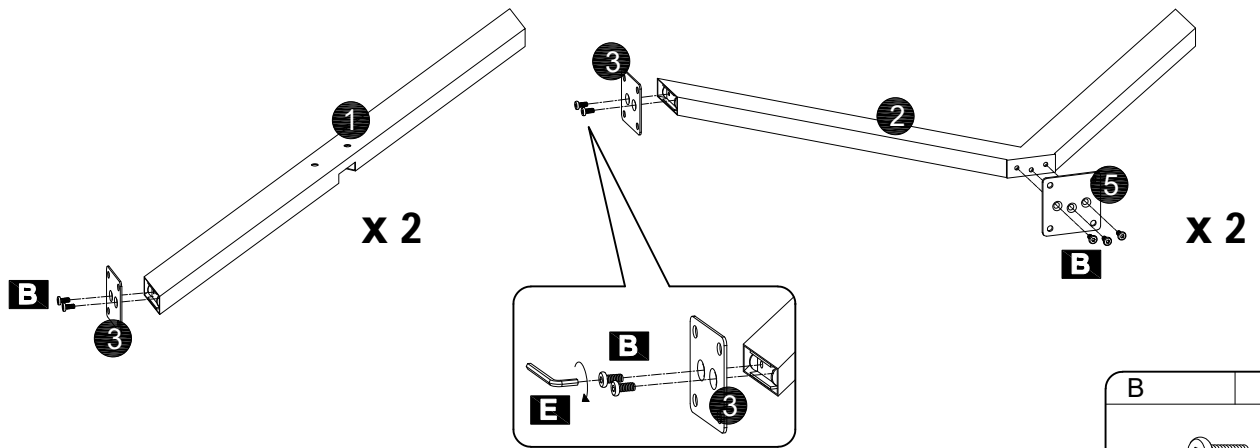

<b>B</b>	x 14
M6x15mm	

2.

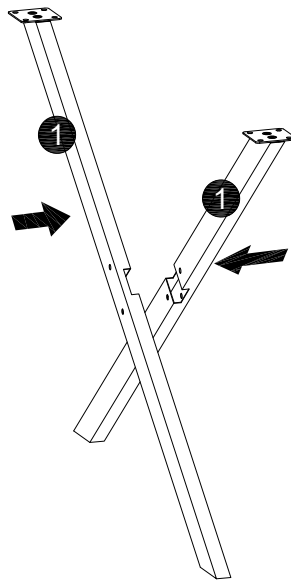

3.

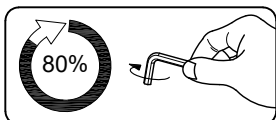
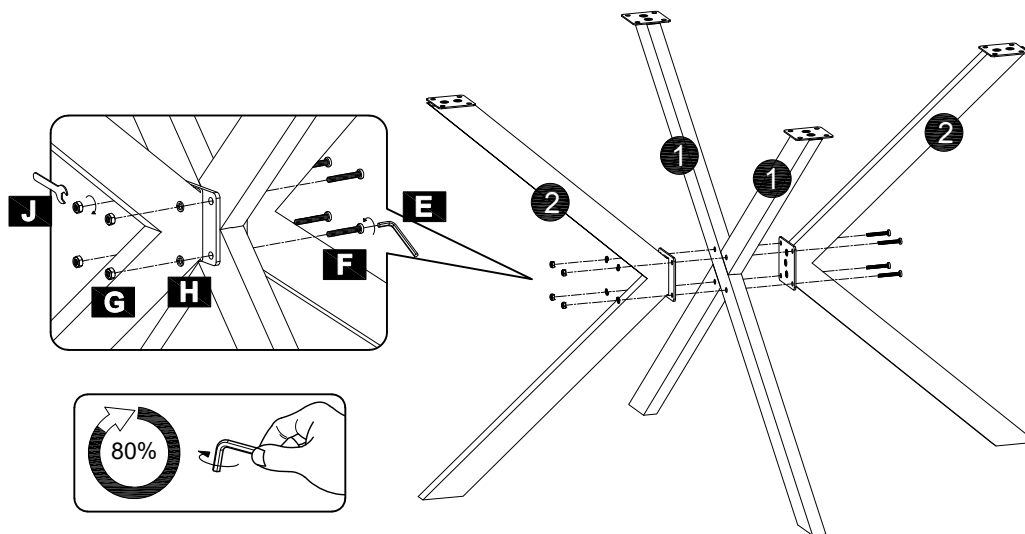



<b>F</b>	x 4
M6x45mm	

<b>G</b>	x 4
M6	

<b>H</b>	x 4
M6	

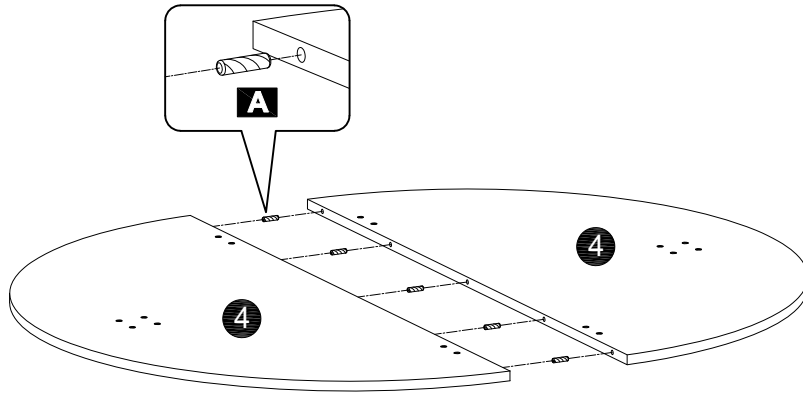
4.



A	x 5
	
Φ8x30mm	

5.

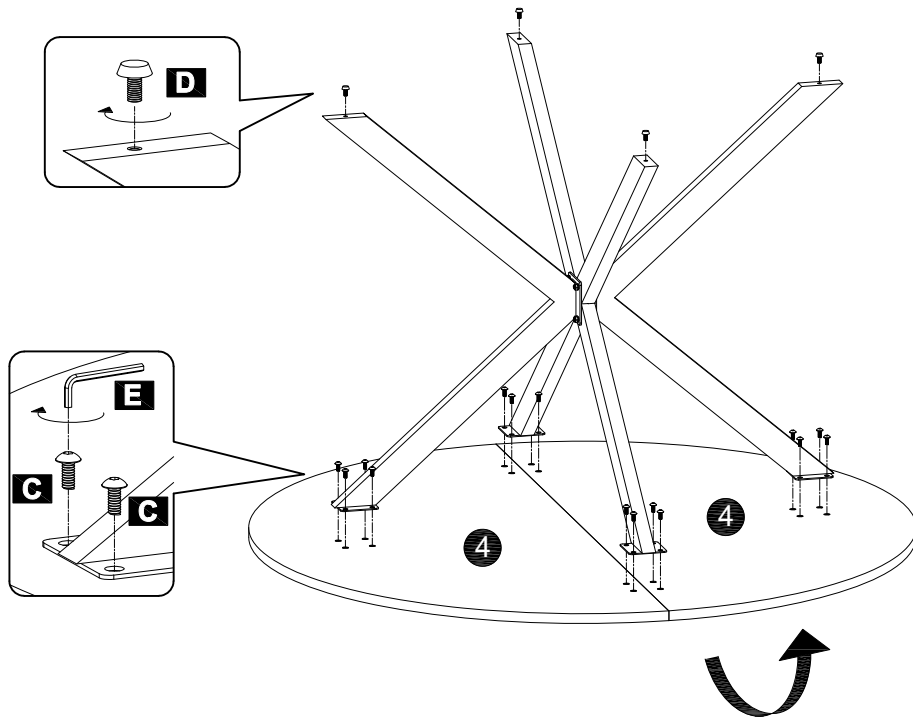

C	x 16
	
M6x12mm	

D	x 4
	

6.

