

ASSEMBLY INSTRUCTIONS

TWIN/TWIN BUNKBED WITH TRUNDLE

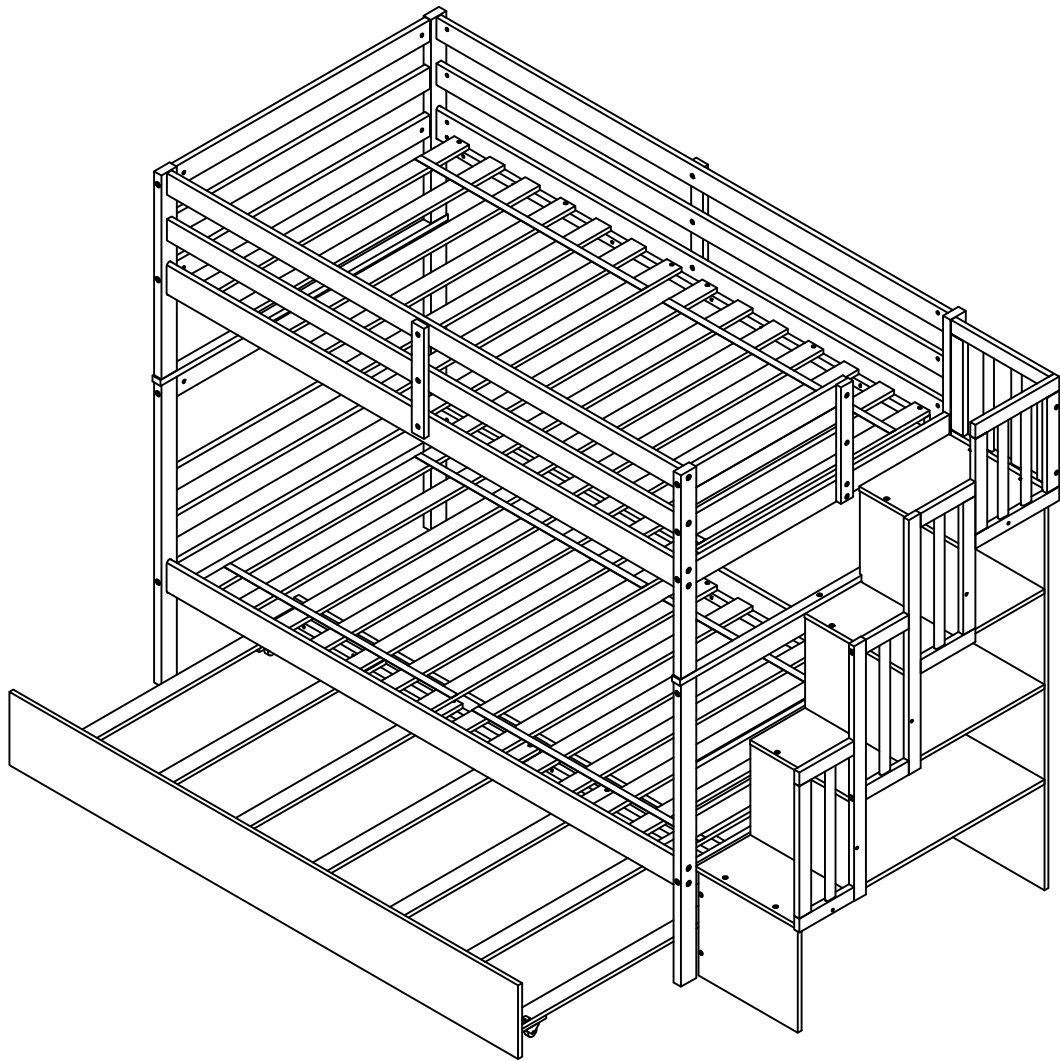

YX5507



SAFETY WARNING



1. This bed is designed for use only mattress (es) meeting the following specifications on the upper bunk, and lower bunk:

Down bed

Bed type	Length	With	Thickness
Twin Standard	74"-75"	38 1/2"	8" max

Up bed (Bunk bed and tribed included)

Bed type	Length	With	Thickness
Twin Standard	74"-75"	38 1/2"	6" max





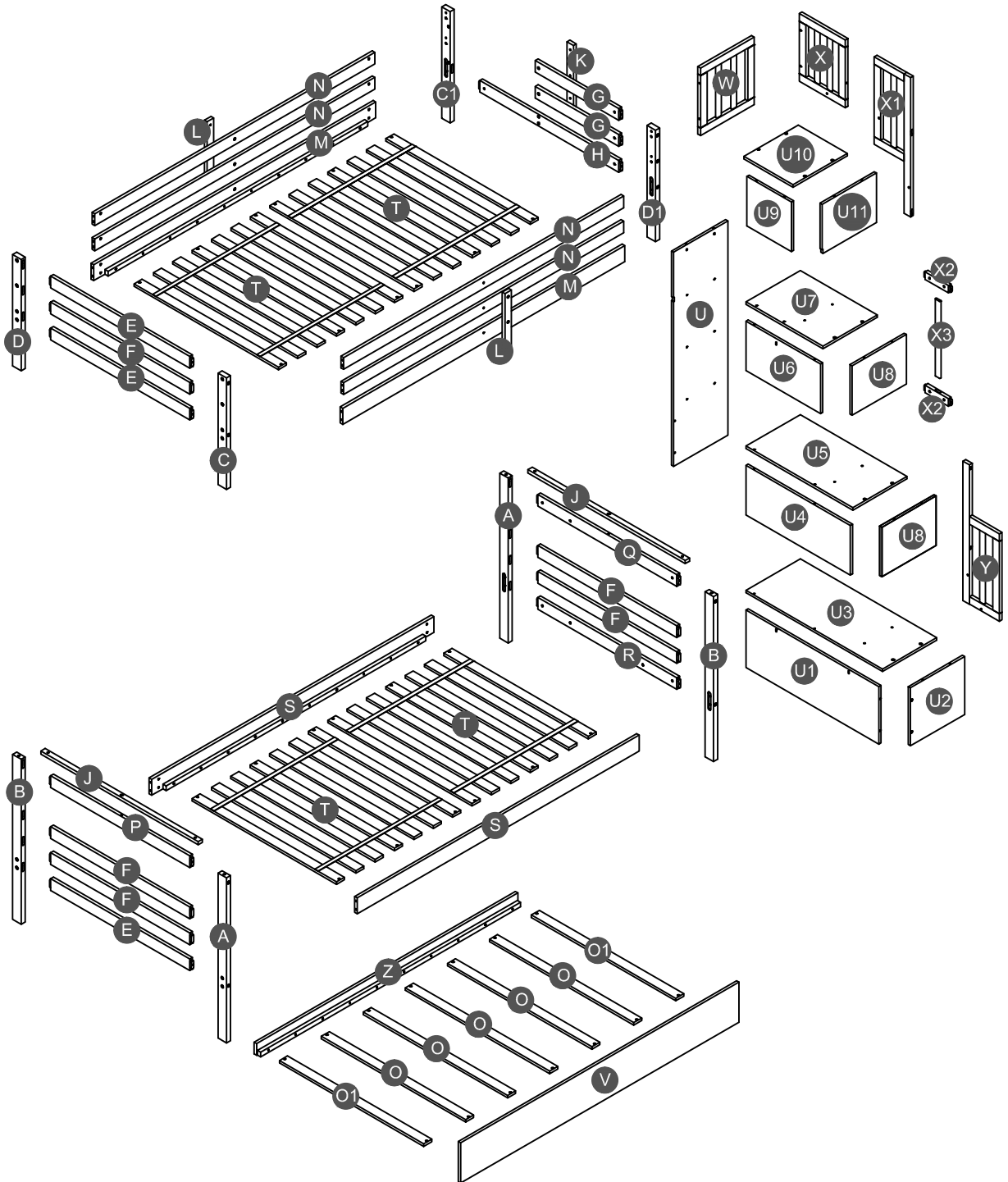

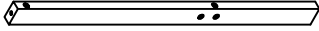
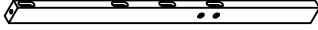
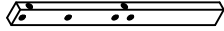

2. Replacement parts, including additional guardrails, maybe obtained from any of our (YX INC.) dealers
3. Follow the information on the warnings appearing on the upper bunk bed end structure and on the carton. Do not remove warning label from bed.
4. Always use the recommended size mattresses or mattress supports, or both, to help prevent the likelihood of entrapment or falls.
5. Surface of mattress must be at least 5" (127mm) below the upper edge of guardrails.
6. Do not allow children under 6 years of age to use the upper bunk.
7. Periodically check and ensure that the guardrail, ladder, and other components are in their proper position, free from damage, and that all connectors are tight.
8. Do not allow horseplay on or under the bed and prohibit jumping on the bed.
9. Always use the ladder for entering and leaving the upper bunk.
10. Do not use substitute part. Contact the manufacture or dealer for replacement part.
11. Use of a night light may provide added safety precaution for a child using the upper bunk.
12. Always use guardrails on both long sides of the upper bunk. If the bunk bed will be placed next to the wall, the guardrail that runs the full length of the bed should be placed against the wall to prevent entrapment between the bed and wall.
13. The use of water or sleep flotation mattresses is prohibited.
14. STRANGULATION HAZARD - Never attach or hang items to any part of the bunk bed that are not designed for use with the bed; for example, but not limited to, hook, belts and jump ropes.
15. Keep these instruction for future reference.

Detail View



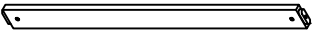
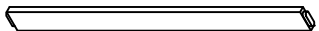
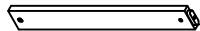
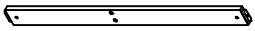

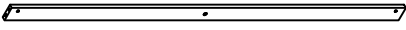
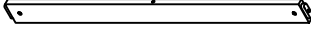
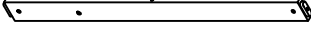
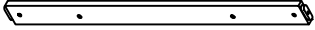
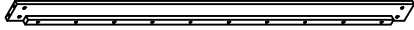
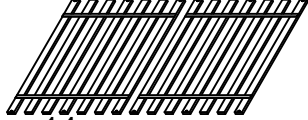
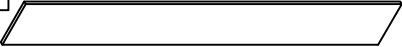

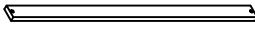
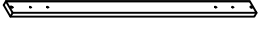



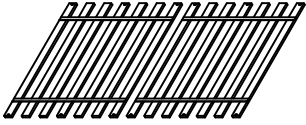
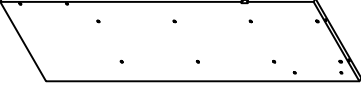
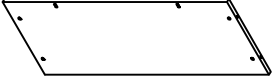
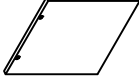
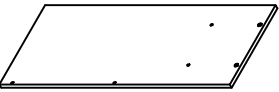
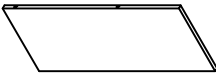

Part List

Hardware List + YX5507(2-1)

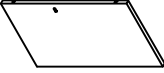

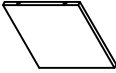
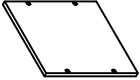

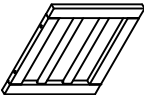
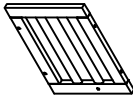
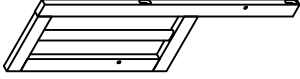

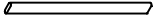
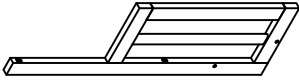

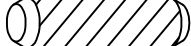
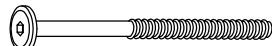
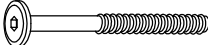

A  Lower leg (Left front /Right back) - 2pcs	B  Lower leg (Left back /Right front) - 2pcs	C  Upper leg (Left front) - 1pc
C1  Upper leg (Right back) - 1pc	D  Upper leg (Left back) - 1pc	D1  Upper leg (Right front) - 1pc
E  Horizontal - 3pcs	F  Horizontal HB/FB - 5pcs	G  Upper horizontal FB - 2pcs
H  Upper horizontal FB - 1pc	J  Cap for lower HB&FB-2pcs	M  Upper front & back side rail-2pcs
N  Guard rail - 4pcs	P  Lower horizontal HB - 1pc	Q  Lower horizontal FB - 1pc
R  Lower horizontal FB - 1pc	S  Lower front & back side rail-2pcs	T  Slats - 14pcs
V  Front panel of trundle - 1pc	Z  Back panel side rail of trundle - 1pc	O  Trundle slats - 5pcs
O1  Trundle slats - 2pcs		

Part List

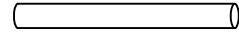
YX5507(2-2)

K  Support guard rail - 1pc	L  Vertical guard rail - 2pcs	T  Slats - 14pcs
U  Back panel - 1pc	U1  Lower left side panel - 1pc	U2  Lower front panel - 1pc
U3  Lower step ladder panel -1pc	U4  Lower left side panel - 1pc	U5  Lower step ladder panel -1pc
U6  Lower left side panel - 1pc	U7  Lower step ladder panel -1pc	U8  Lower front panel - 2pcs
U9  Upper left side panel - 1pc	U10  Upper step ladder panel -1pc	U11  Upper front panel - 1pc
W  Upper guard back - 1pc	X  Upper guard side - 1pc	X1  Upper guard side - 1pc
X2  Horizontal guard side - 2pcs	X3  Support guard side -1pc	Y  Lower guard side - 1pc

Hardware List

1  Ø8*30mm Wood dowel (12pcs)	2  Ø10*40mm Wood dowel (8pcs)	3  (Ø15)1/4"*100mm Hex-Head bolts (16pcs)
4  (Ø15)1/4"*80mm Hex-Head bolts (28pcs)	5  (Ø12)1/4"*60mm Hex-Head bolts (36pcs)	6  (Ø12)1/4"*30mm Hex-Head bolts (13pcs)
7  40*18*18*2mm Metal bracket (2pcs)	8  1/4"*15 (9.5mm) Horizontal-Hole bolts(79pcs)	9  Ø9*90mm Connecting bar (4pcs)
10  (Ø12)1/4"*40mm Hex-Head bolts (2pcs)	11  (1/4")4.5*58mm Allen key (1pc)	12  Ø4*30mm Wood screws (46pcs)
13  Ø1/4"*19*2mm Flat Washer (3pcs)	14  95*95*18*3mm Metal bracket (2pcs)	15  Ø3.5*15mm Wood screws (16pcs)
16  100*63*20mm Wheels (4pcs)		

ASSEMBLY TOOLS REQUIRED (NOT INCLUDED)

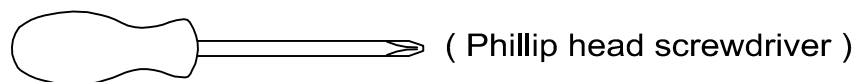

DO NOT USE POWER TOOLS TO ASSEMBLE THIS PRODUCT !

Remark: We recommend you assemble your bed in the flat ground.

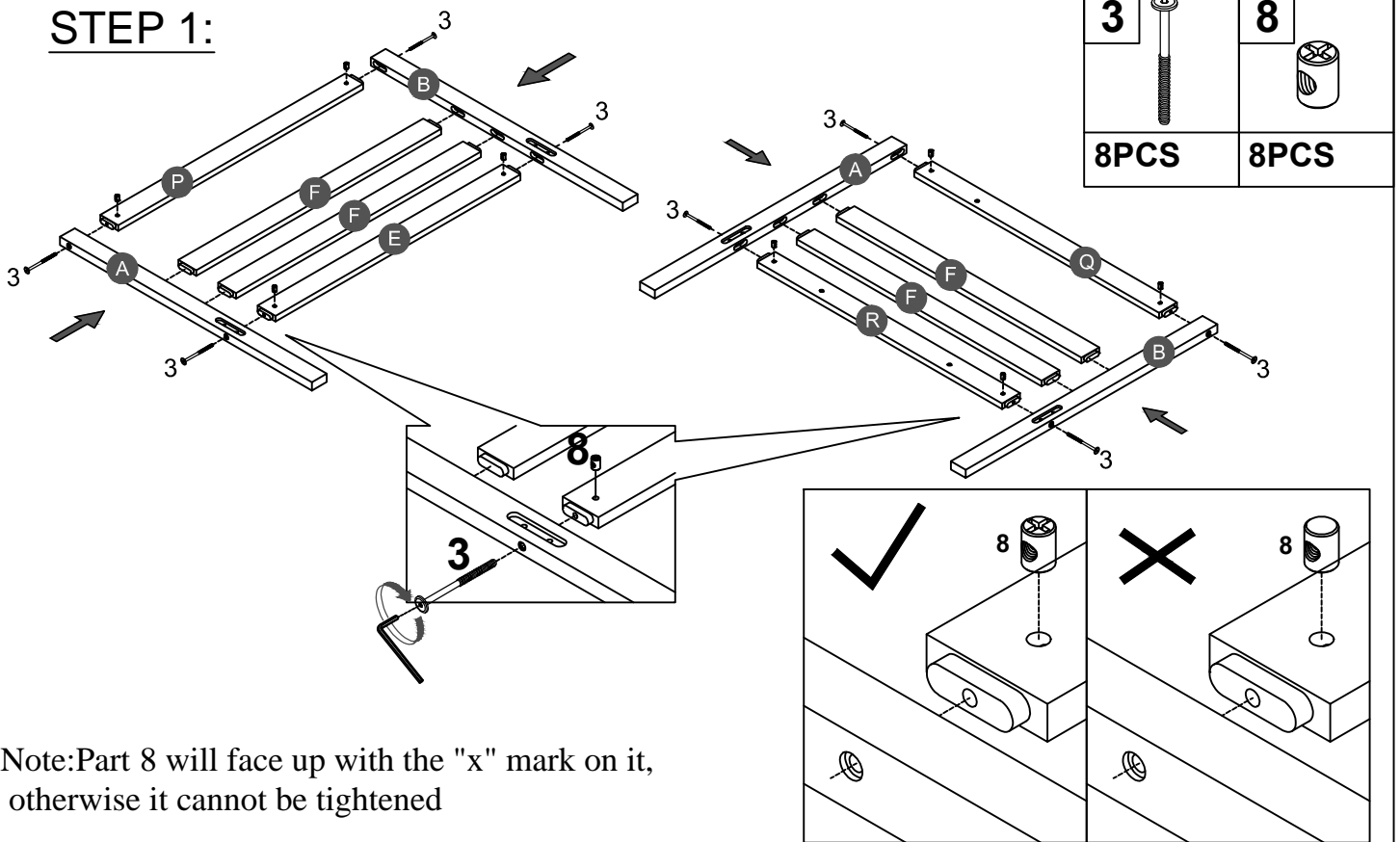

STEP 1:

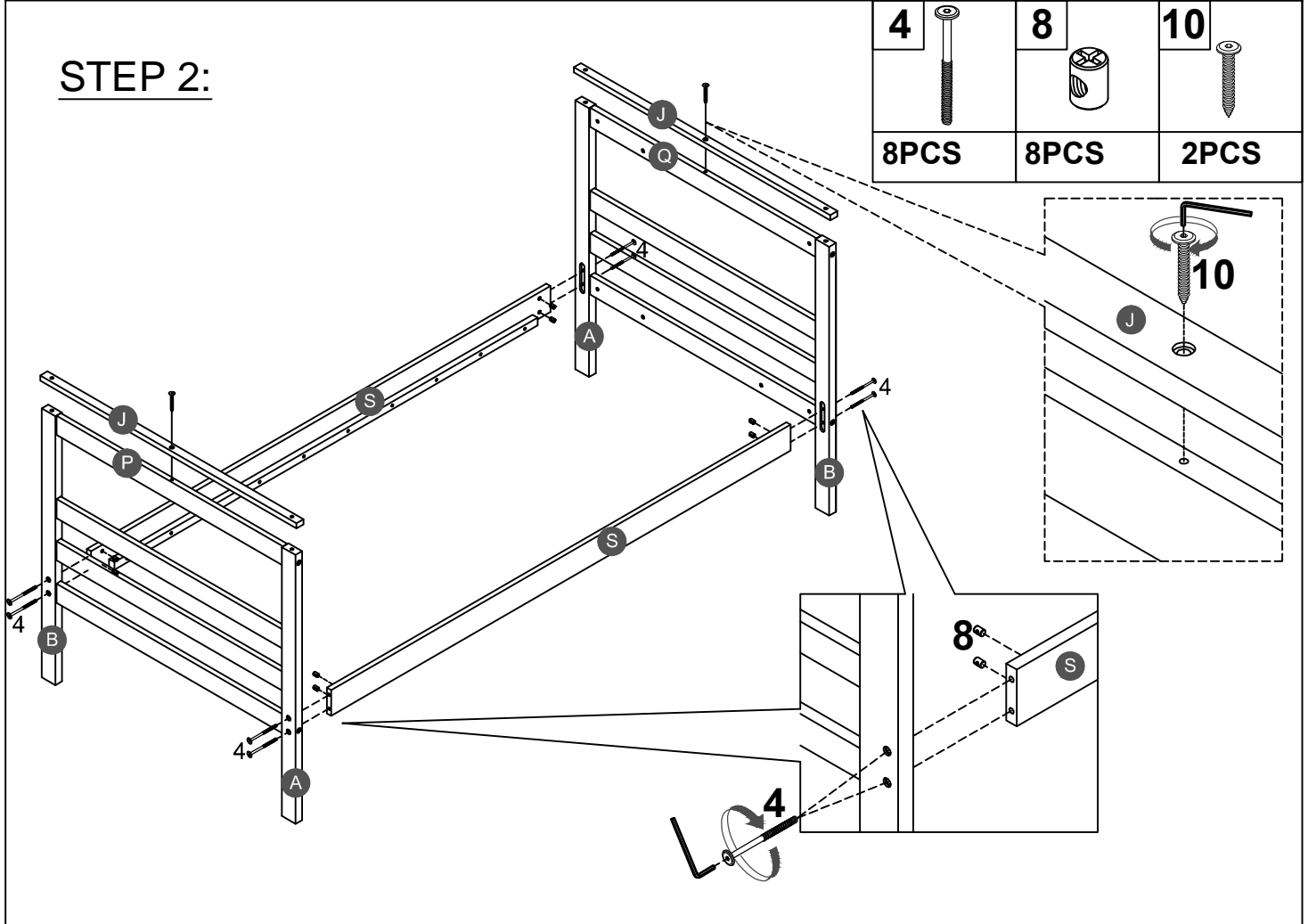

STEP 2:

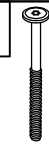

STEP 3:

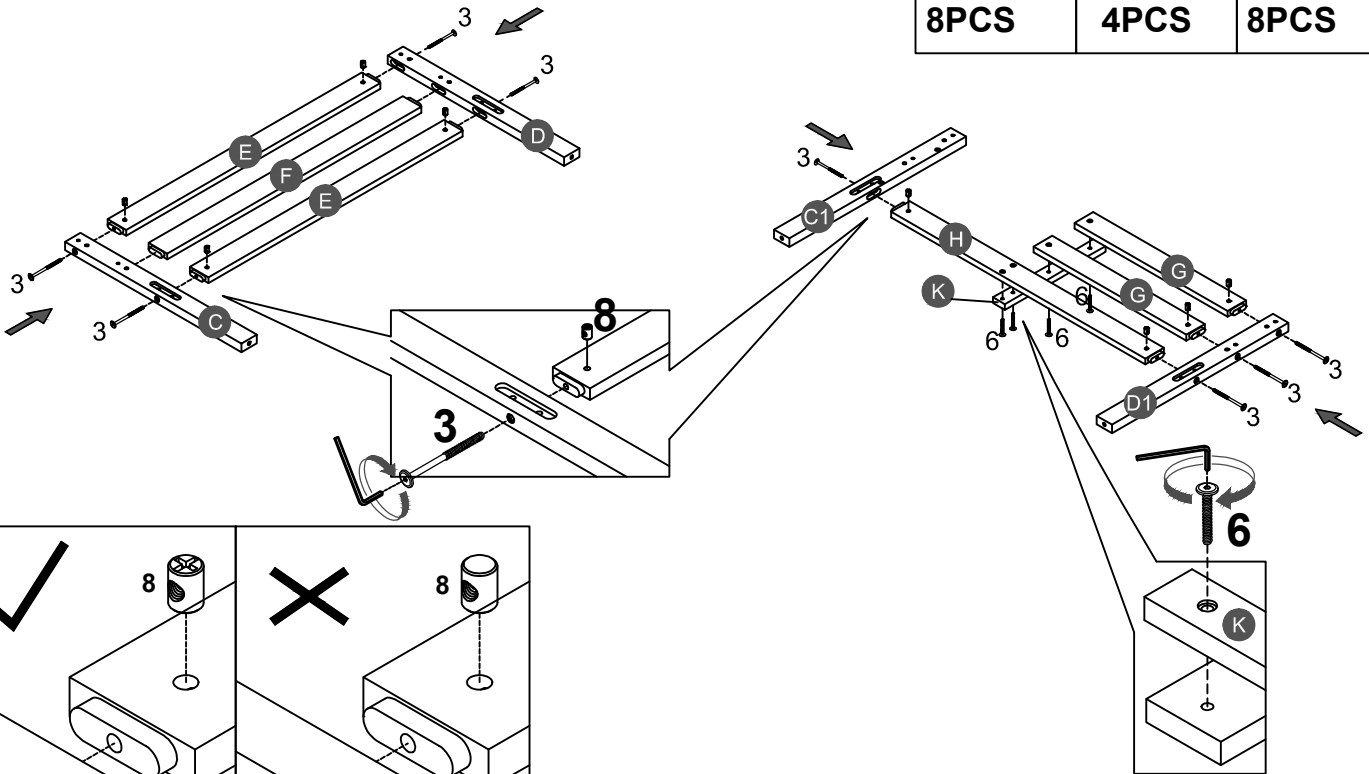

3 	6 	8 
8PCS	4PCS	8PCS



Note: Part 8 will face up with the "x" mark on it, otherwise it cannot be tightened

STEP 4:

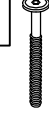
Balcony don't tighten these yet . Leave them a bit loose to make fitting the lower side rail more easily.

2 	4 	6 	8 
8PCS	16PCS	6PCS	16PCS

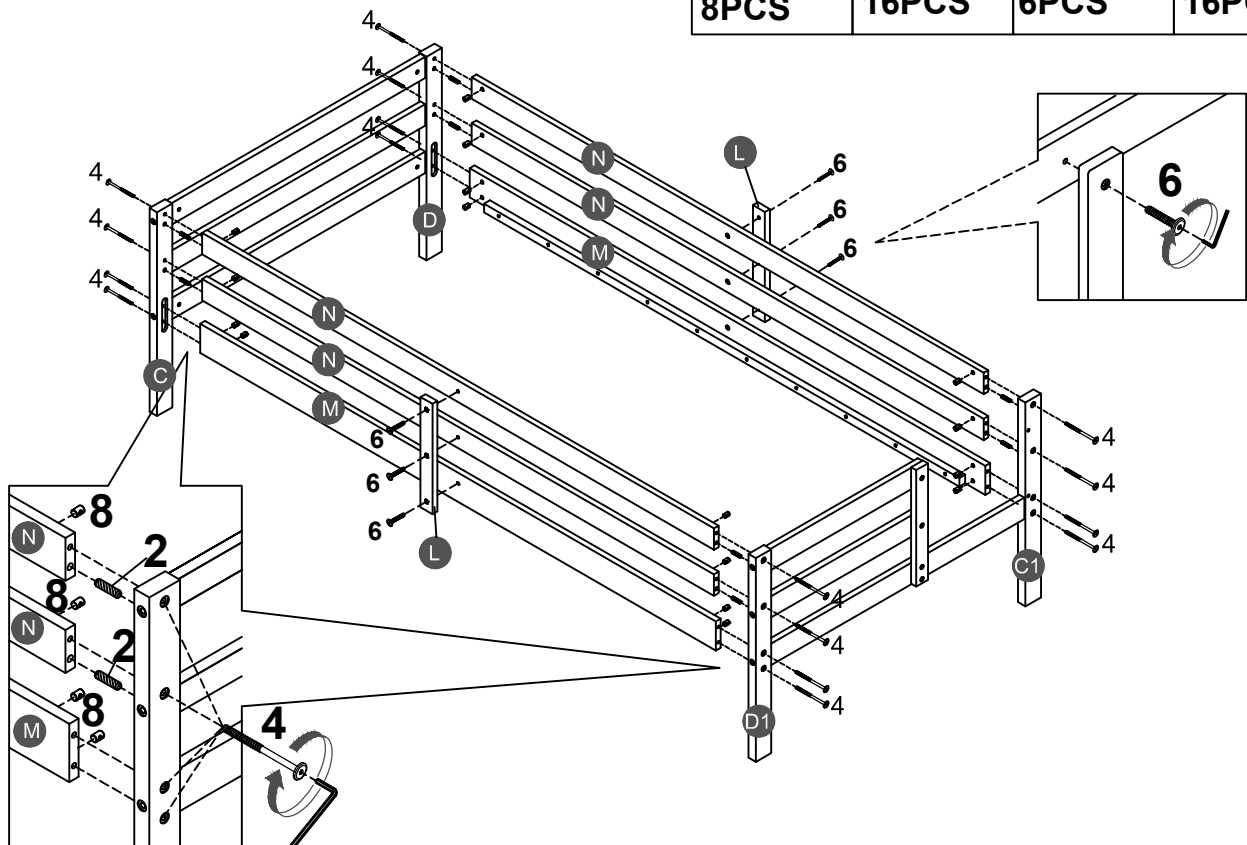

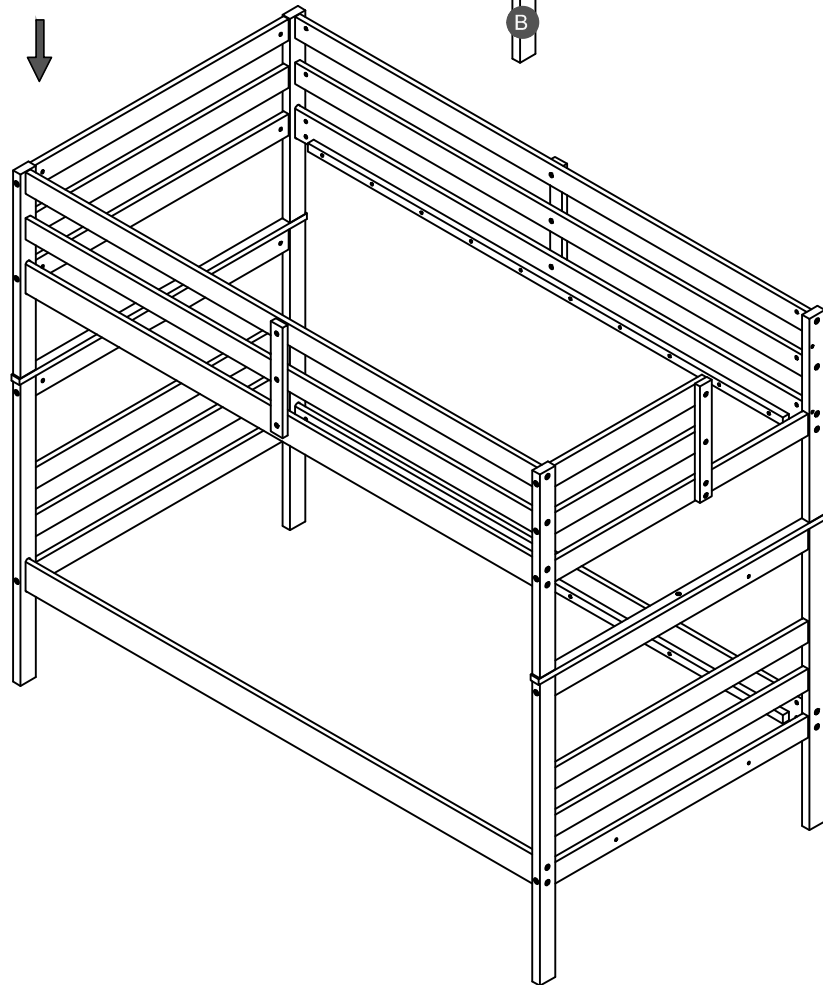
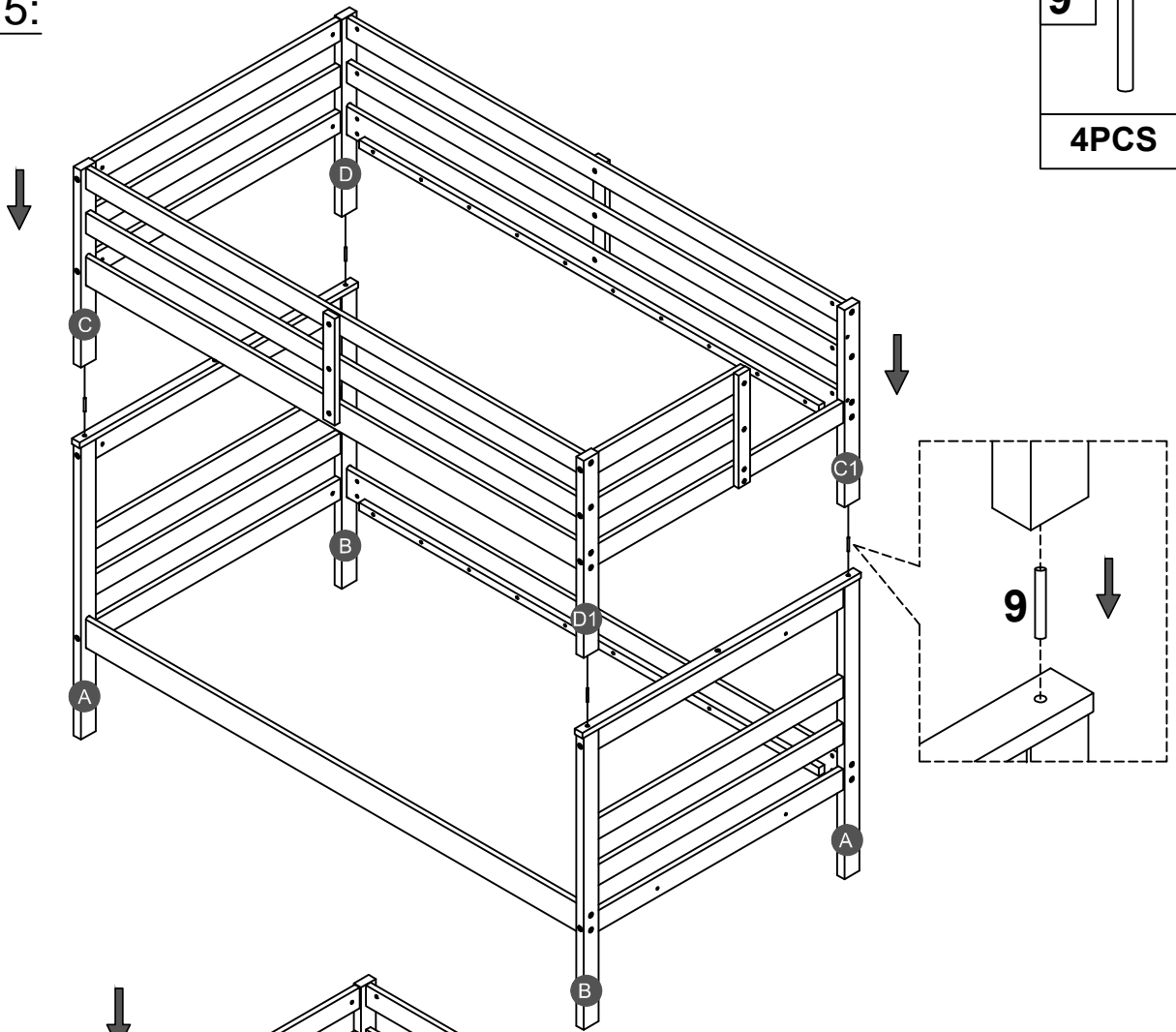

STEP 5:

9	
4PCS	





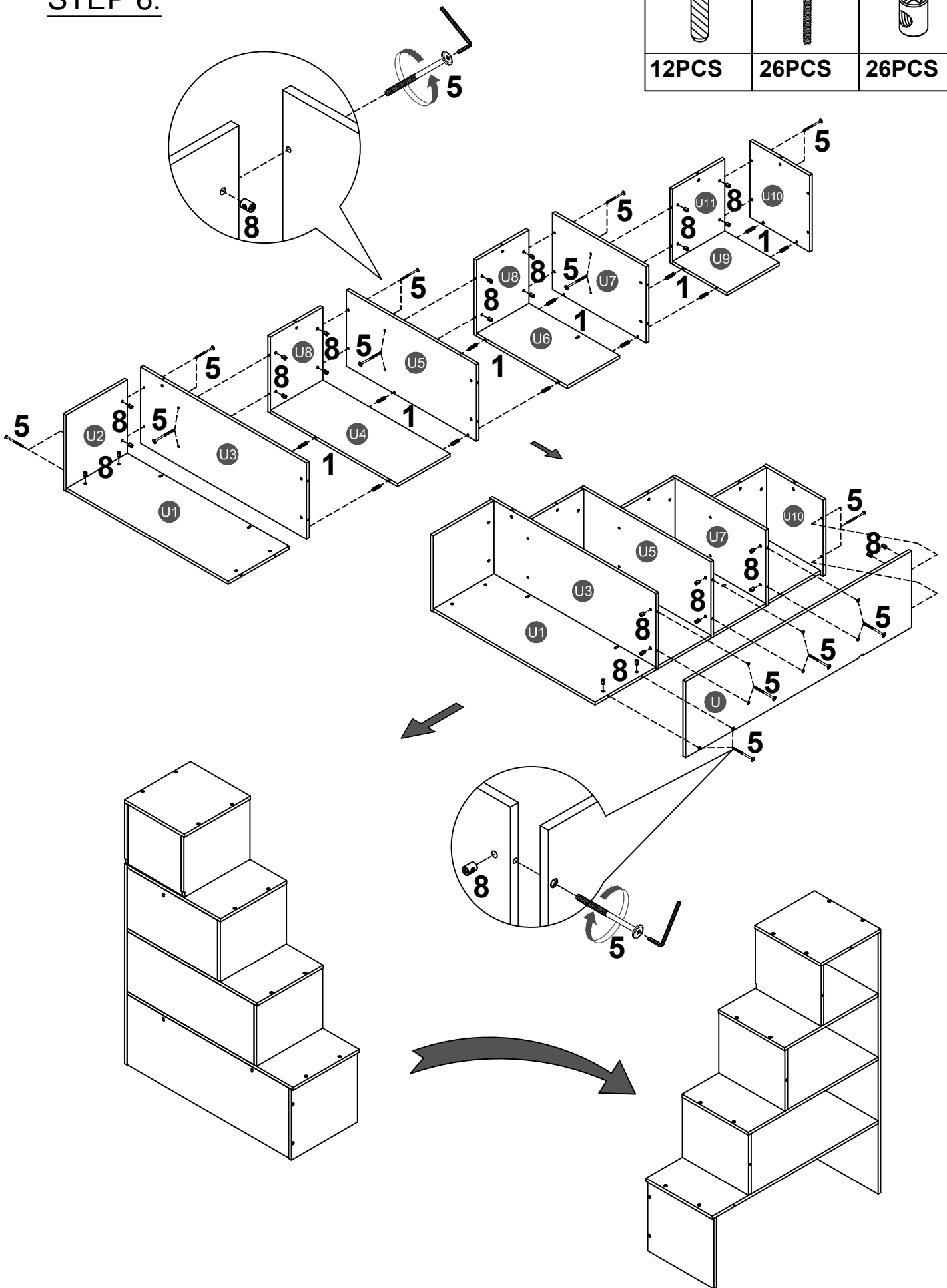

STEP 6:

1		5		8	
12PCS		26PCS		26PCS	



STEP 7:

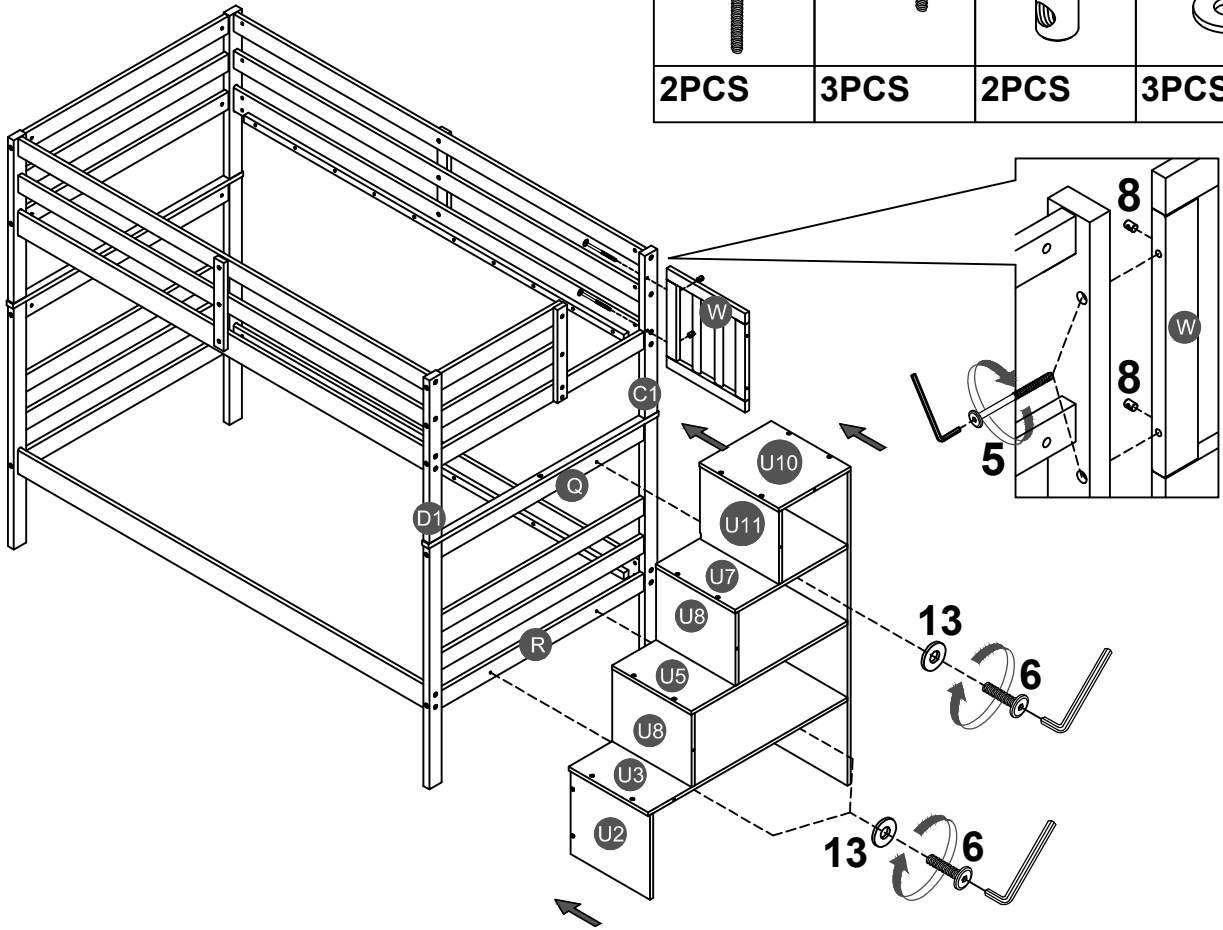

5		6		8		13	
2PCS		3PCS		2PCS		3PCS	

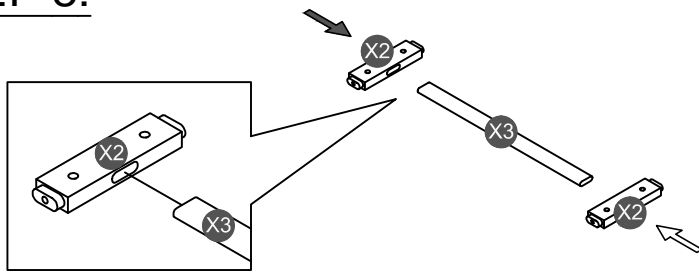

STEP 8:



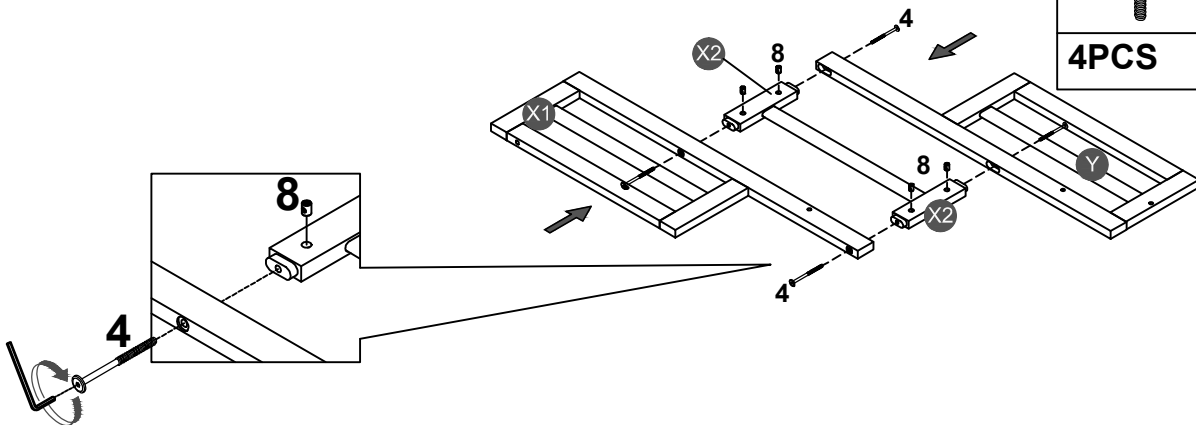

STEP 9:

4		8	
4PCS		4PCS	



STEP 10:

5		8	
8PCS		7PCS	

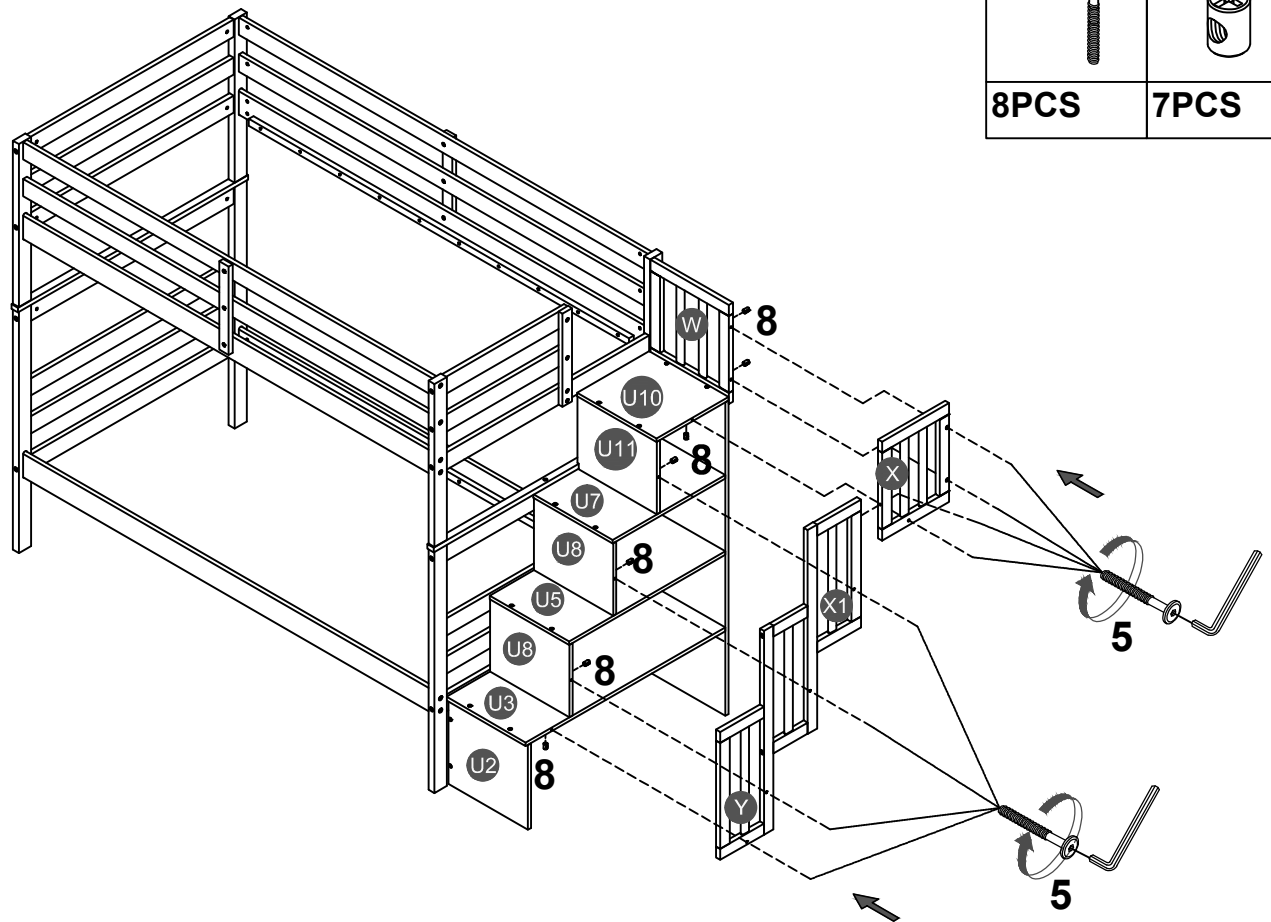

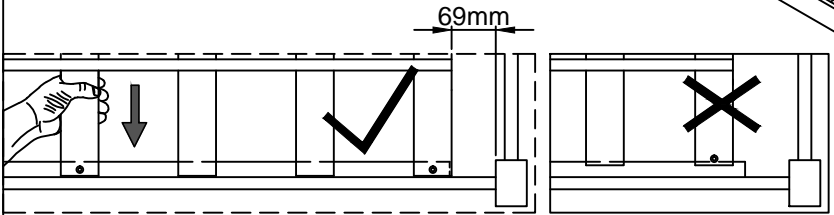
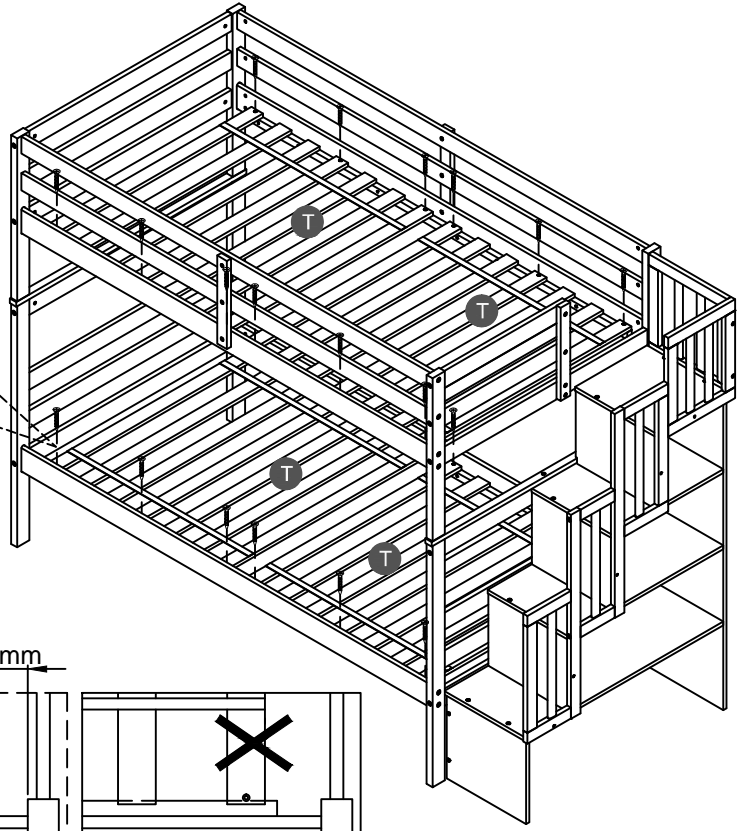
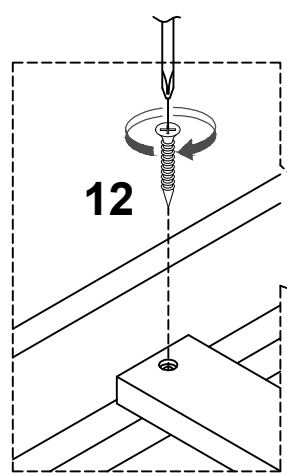

STEP 11:

12	
24PCS	

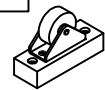

Note: Do not lock the screws of the bed slats to the outermost edge of the bed slats, you need to leave a certain space at the edges, otherwise it will cause the board to break. Do not lock the bed slats on the edge of the wood, please hold firmly before screwing, hold it in place with one hand, then lock the screw.

STEP 12:

16 	12 
4PCS	8PCS

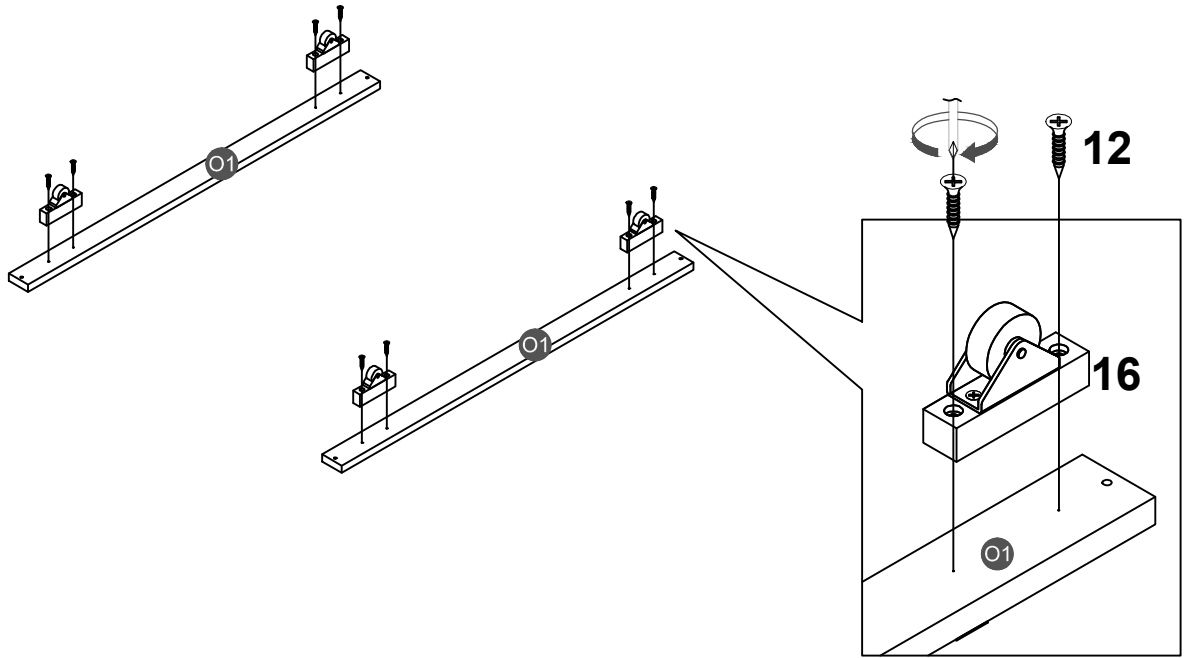

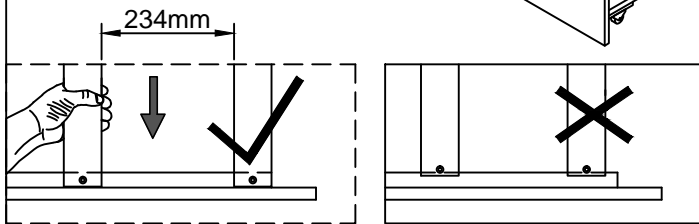
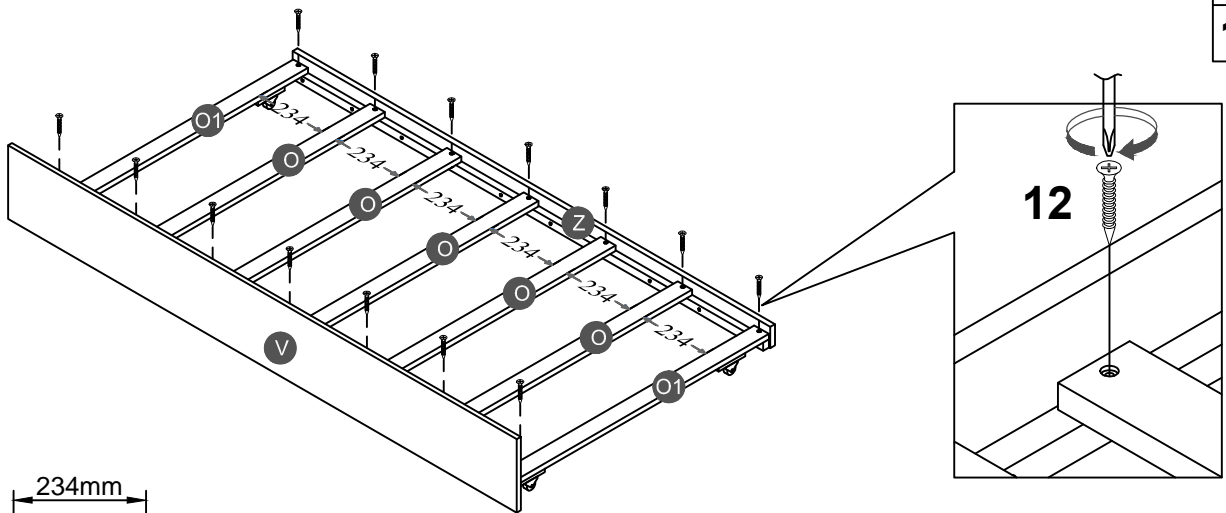

STEP 10:

12 
14PCS





Note: Do not lock the screws of the bed slats to the outermost edge of the bed slats, you need to leave a certain space at the edges, otherwise it will cause the board to break.
Do not lock the bed slats on the edge of the wood, please hold firmly before screwing , hold it in place with one hand, then lock the screw.

STEP 14:

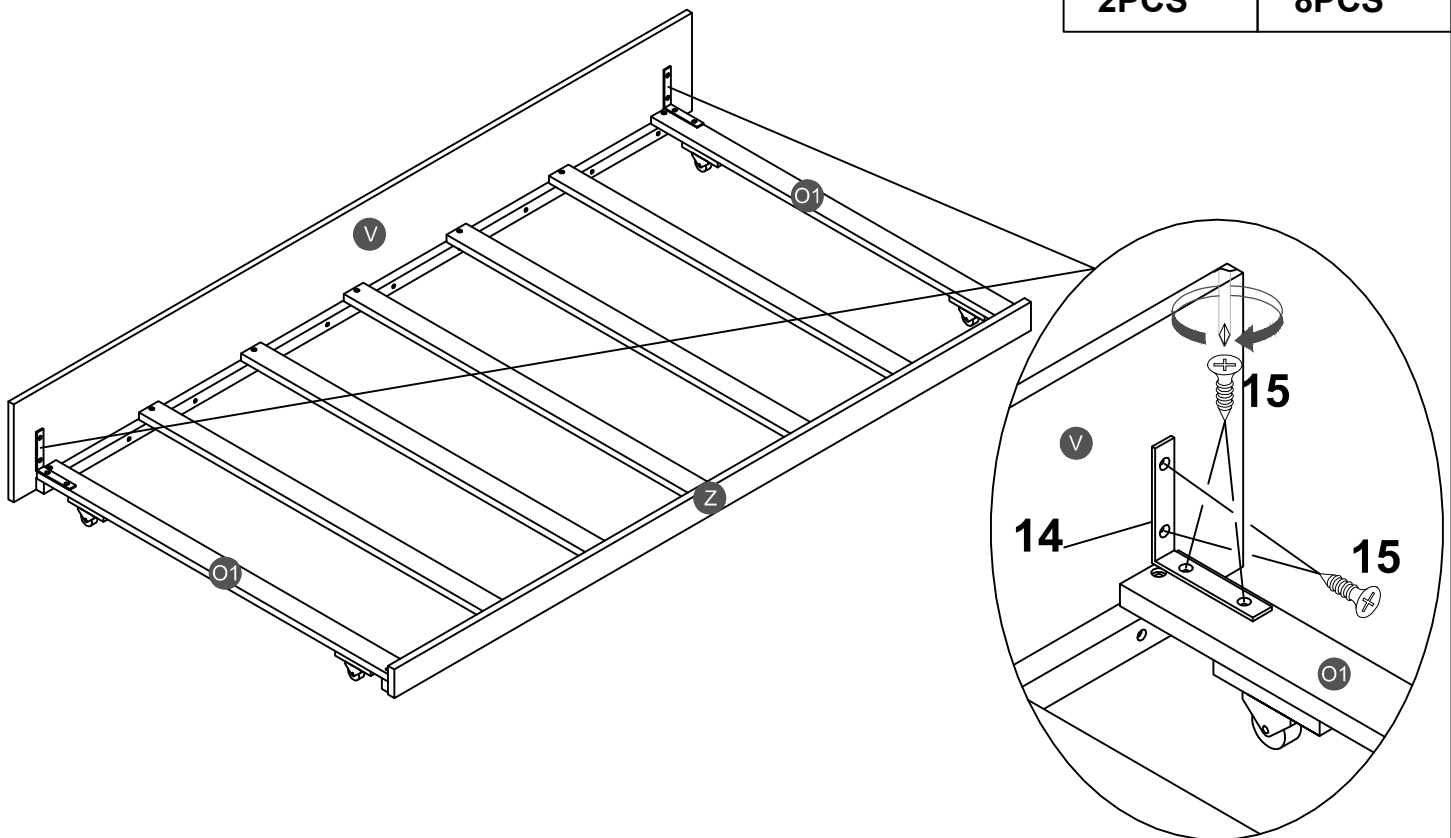
14	15
	
2PCS	8PCS



STEP 15:

15	7
	
8PCS	2PCS

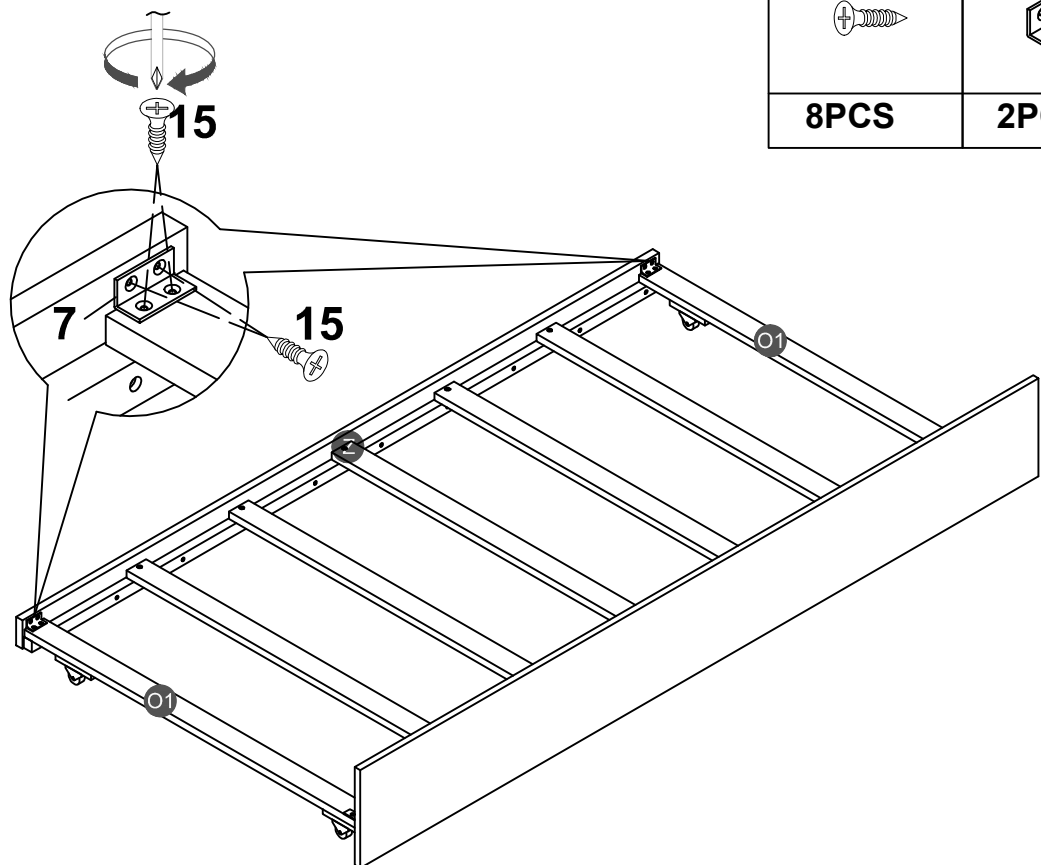

STEP 16:

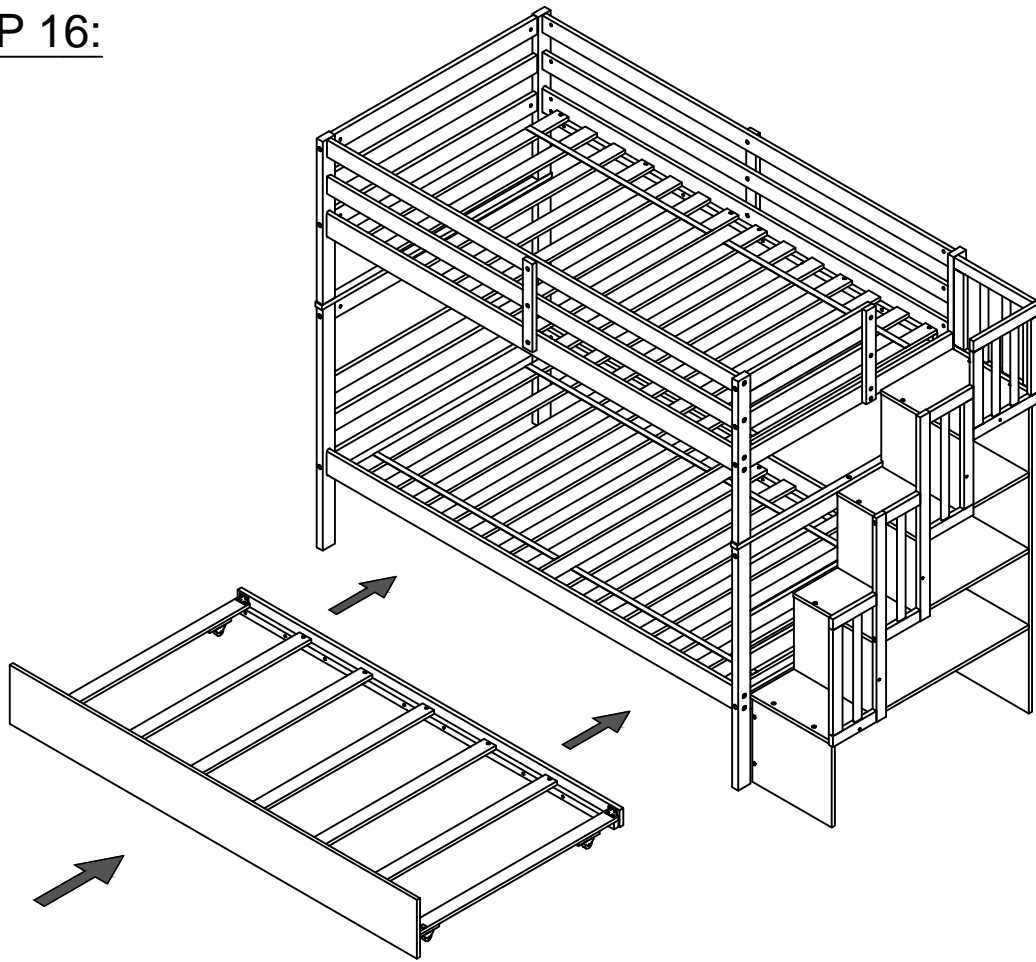

Push Trundle under the bottom of Bunkbed.

