

Assembly Instructions

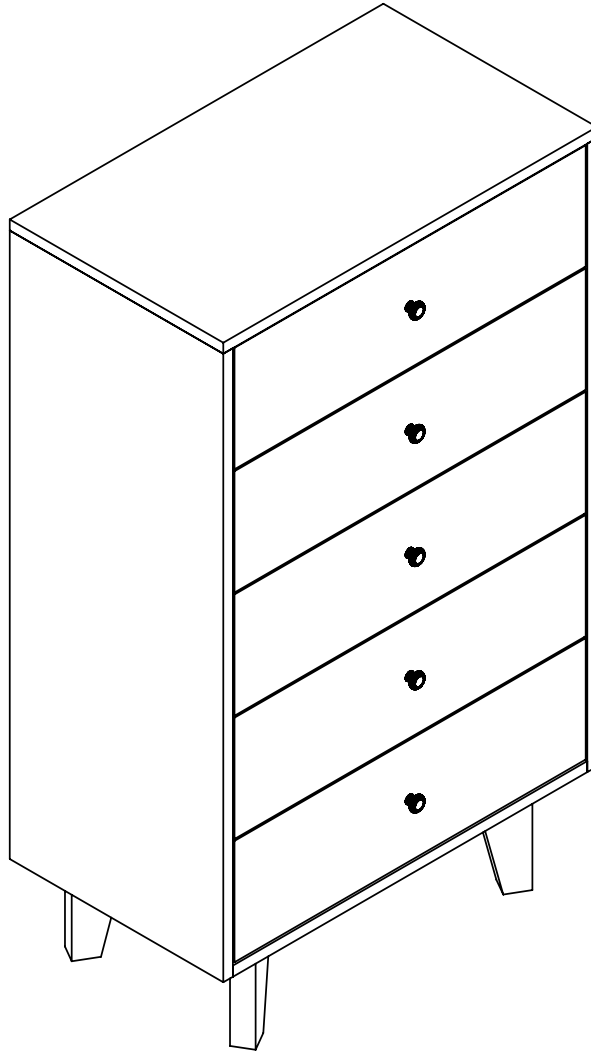

Thank you for your purchase.
Please follow the instructions below for correct assembly.

▲ For higher efficiency, we recommend to use a power drill; the power drill should be set on the low speed to avoid screw stripping.

CAUTION

This package contains small parts and hardware; keep it from children to avoid accidental swallowing.



WARNING: Any furniture that is not anchored to a wall has the risk of tipping over in certain circumstances, i.e. when a child attempts to climb up on the furniture or in the event of an earthquake. Accordingly, we recommend that all furniture is anchored to a wall. We supply a free safety wall anchor with all furniture sold and we recommend these are used to prevent your product from tipping over.

Disclaimer

All information provided in this manual, including but not limited to notes, pictures, instructions, schematic diagrams, assembly procedures and safety precautions, etc., is in good faith and every reasonable effort has been made to ensure that the provided information is proper, correct and accurate to the best of the manufacturer's knowledge.

Under no circumstance shall the manufacturers, the distributors, the sales agents and the associates, contractors and employees of the above organizations be held liable for any direct, indirect, consequential or incidental losses, damages, injuries or accidents of any kind incurred as a result of the assembly, adjustment and use of the furniture contained in this box. By reading this manual and decide to proceed, you are deemed to agree to accept full personal responsibility and liability for any possible personal injury or damage you suffer from your actions, directly or indirectly, arising out of or in connections with the assembly, adjustment and use of the furniture.



Caution!

Personal injury can occur during the assembly and adjustment of the furniture contained in this box. You will be solely responsible for your personal safety.

PPE Recommendations

Proper PPEs (Personal Protection Equipment) are recommended to use during assembly and adjustment of the furniture.









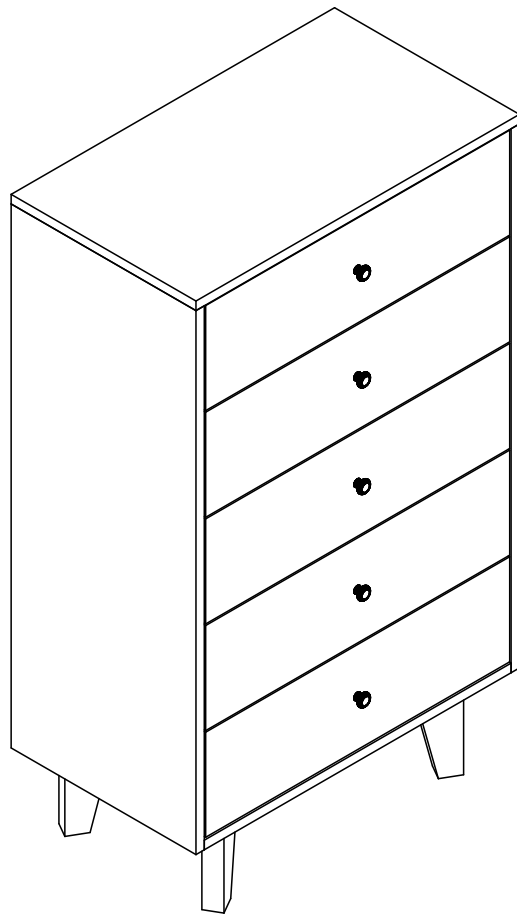





Gloves

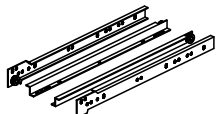



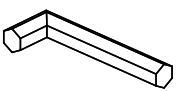

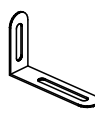
Safety
Goggles



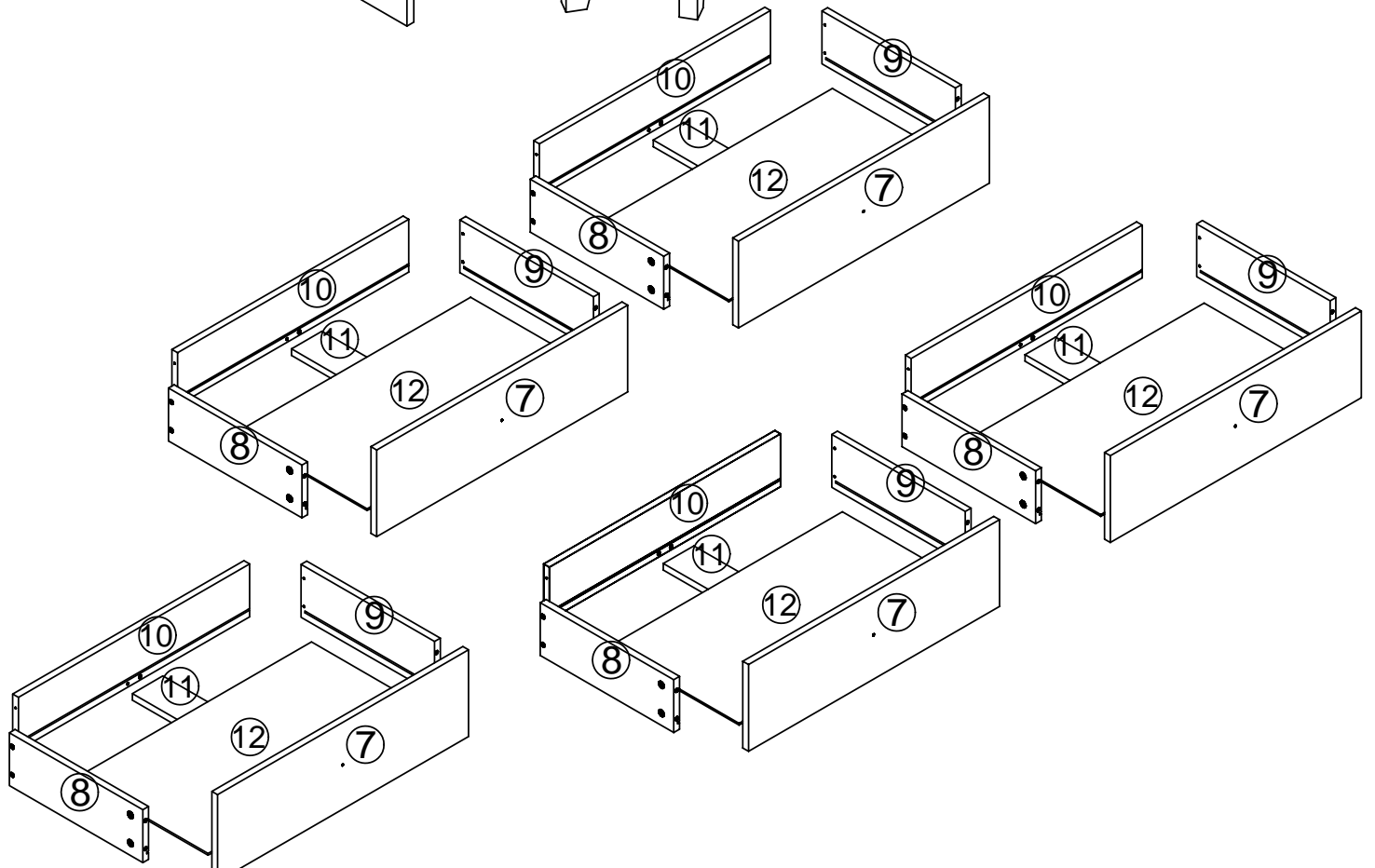
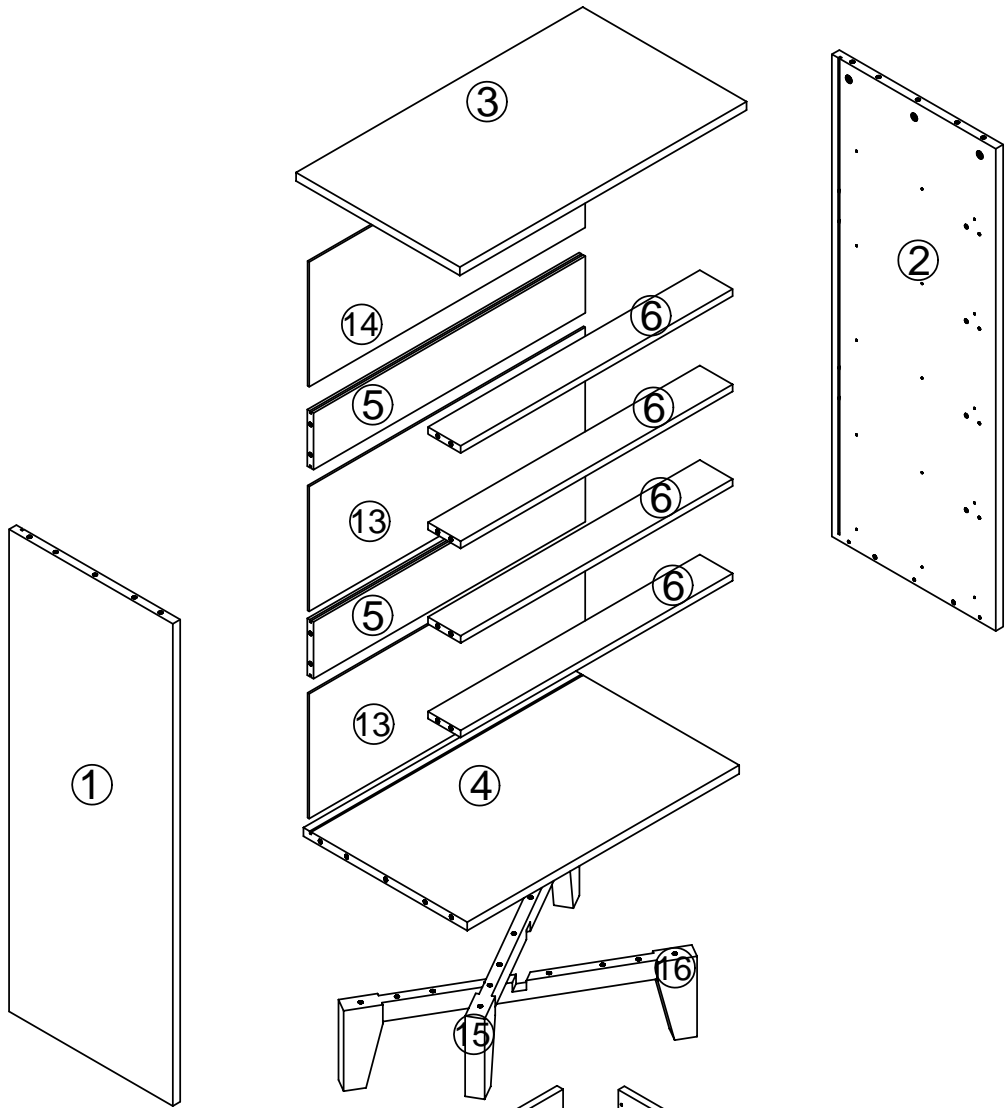



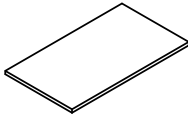
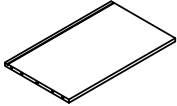

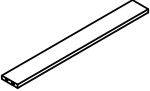
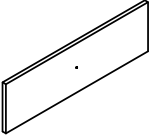
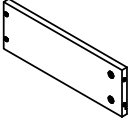
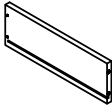
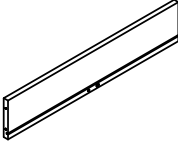
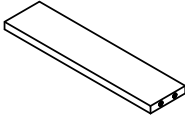
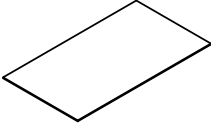
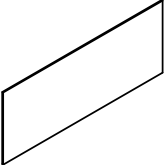
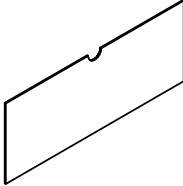
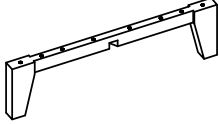
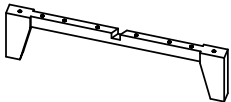
		 $\Phi 8 \times 30$	 $\Phi 3.5 \times 14$	 $\Phi 3.5 \times 16$
A × 58	B × 58	C × 34	D × 50	E × 2
 $\Phi 3.5 \times 35$			 6 × 50	
F × 22	G × 5	H × 5	I × 8	J × 6
				
K × 1	L × 58	M × 1	N × 1	

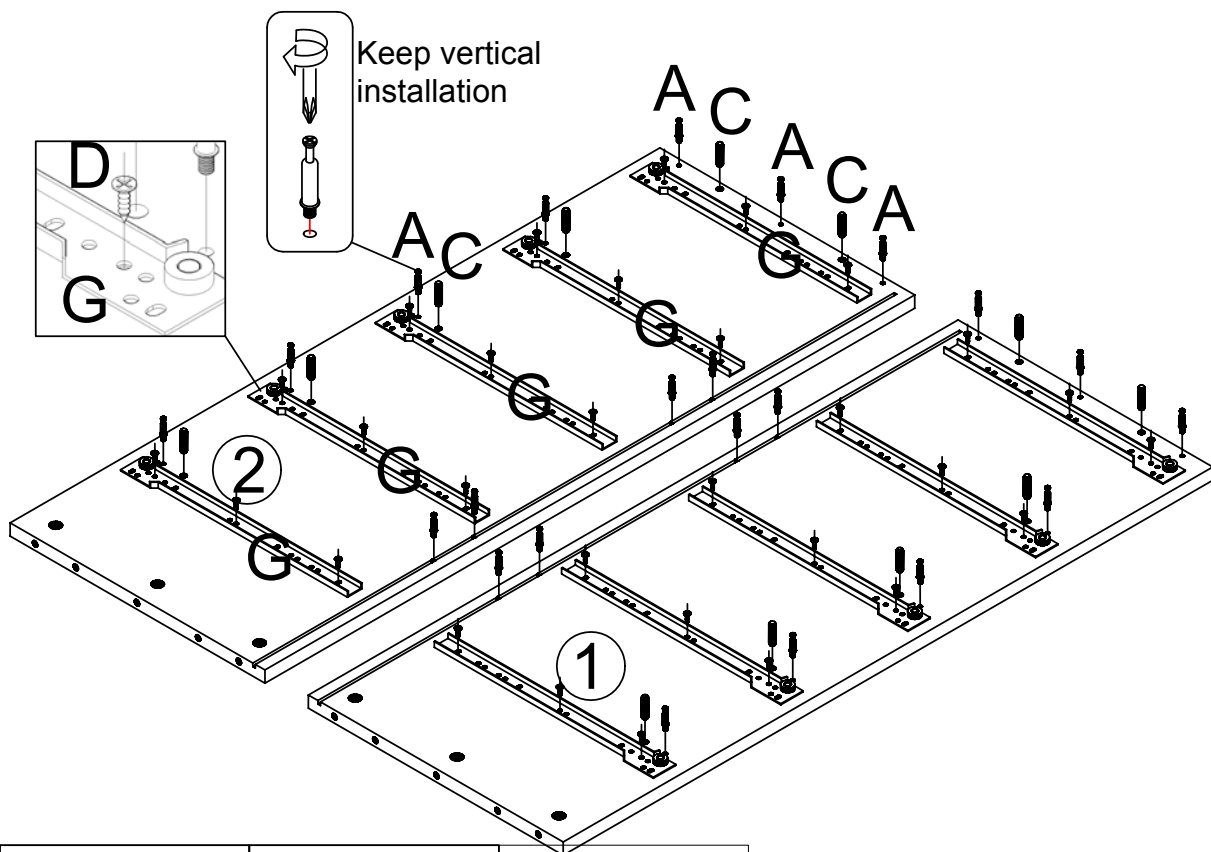

<p>①</p>  <p>1020*399*18mm</p> <p>1PC</p>	<p>②</p>  <p>1020*399*18mm</p> <p>1PC</p>	<p>③</p>  <p>700*400*18mm</p> <p>1PC</p>	<p>④</p>  <p>662*399*18mm</p> <p>1PC</p>
<p>⑤</p>  <p>662*120*15mm</p> <p>2PCS</p>	<p>⑥</p>  <p>662*80*15mm</p> <p>4PCS</p>	<p>⑦</p>  <p>658*197*15mm</p> <p>5PCS</p>	<p>⑧</p>  <p>350*120*15mm</p> <p>5PCS</p>
<p>⑨</p>  <p>350*120*15mm</p> <p>5PCS</p>	<p>⑩</p>  <p>607*120*15mm</p> <p>5PCS</p>	<p>⑪</p>  <p>335*60*15mm</p> <p>5PCS</p>	<p>⑫</p>  <p>617*345*5mm</p> <p>5PCS</p>
<p>⑬</p>  <p>672*264*5mm</p> <p>2PCS</p>	<p>⑭</p>  <p>672*264*5mm</p> <p>1PC</p>	<p>⑮</p>  <p>631.8*170*35mm</p> <p>1PC</p>	<p>⑯</p>  <p>631.8*170*35mm</p> <p>1PC</p>



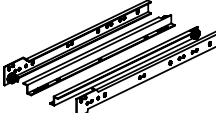

1

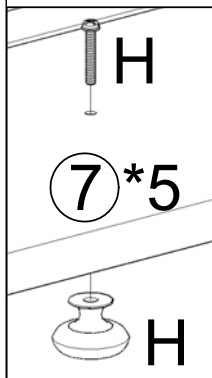
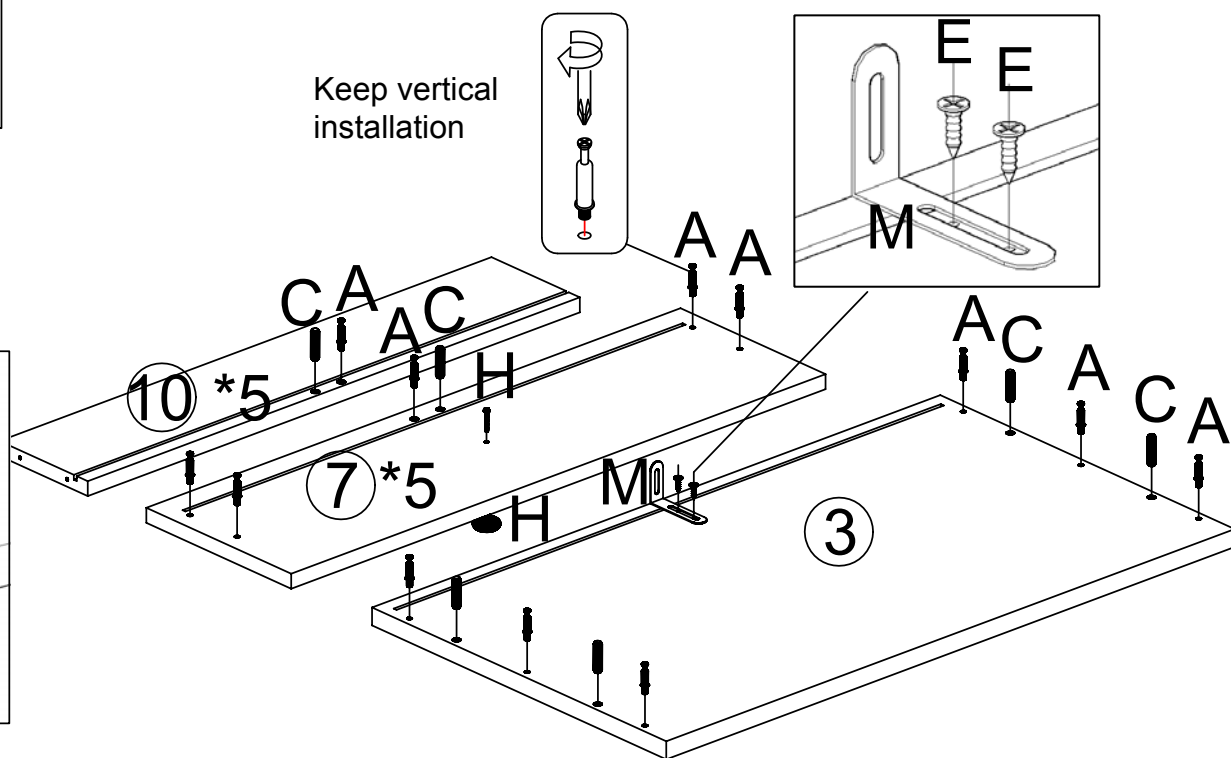

<p>A</p>  <p>22pcs</p>	<p>C</p>  <p>Φ8*30 12pcs</p>	<p>D</p>  <p>Φ3.5*14 30pcs</p>	<p>G</p>  <p>5pcs</p>
---	---	---	---

2

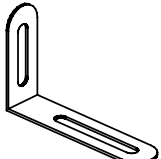

<p>A</p>  <p>36pcs</p>	<p>C</p>  <p>M8*30 14pcs</p>	<p>H</p>  <p>5pcs</p>	<p>M</p>  <p>1pc</p>	<p>E</p>  <p>Φ3.5*16 2pcs</p>
--	--	---	---	---

3

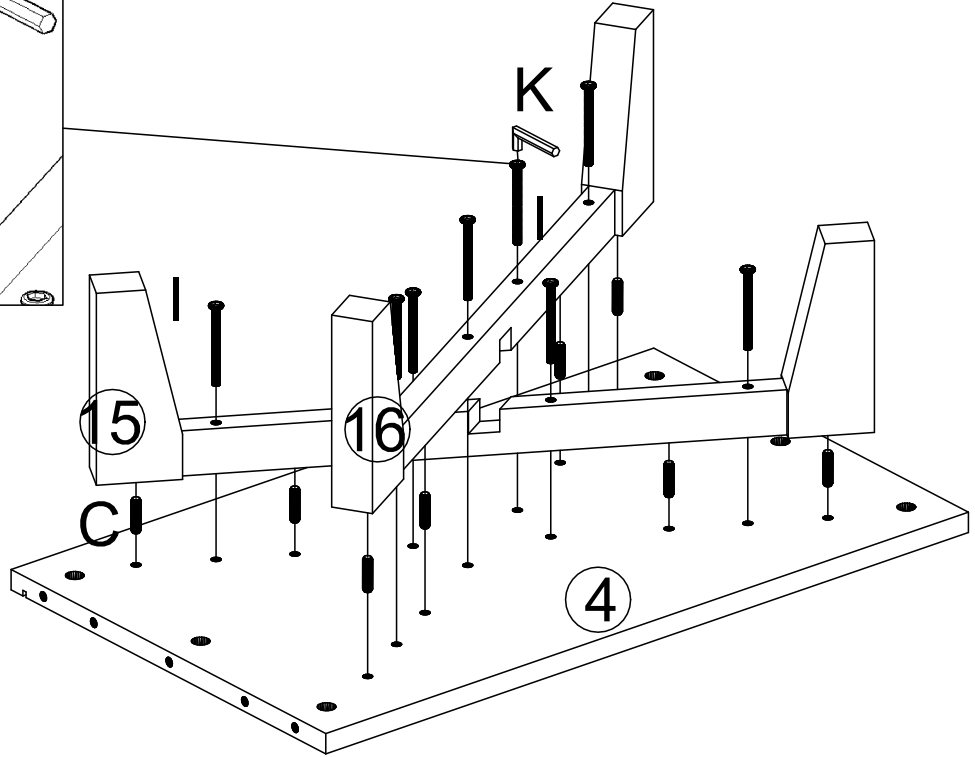
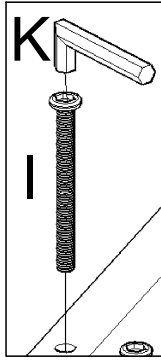
**C** $\Phi 8 \times 30$

8pcs

I $\Phi 6 \times 50$

8pcs

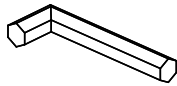
K

1pc

4

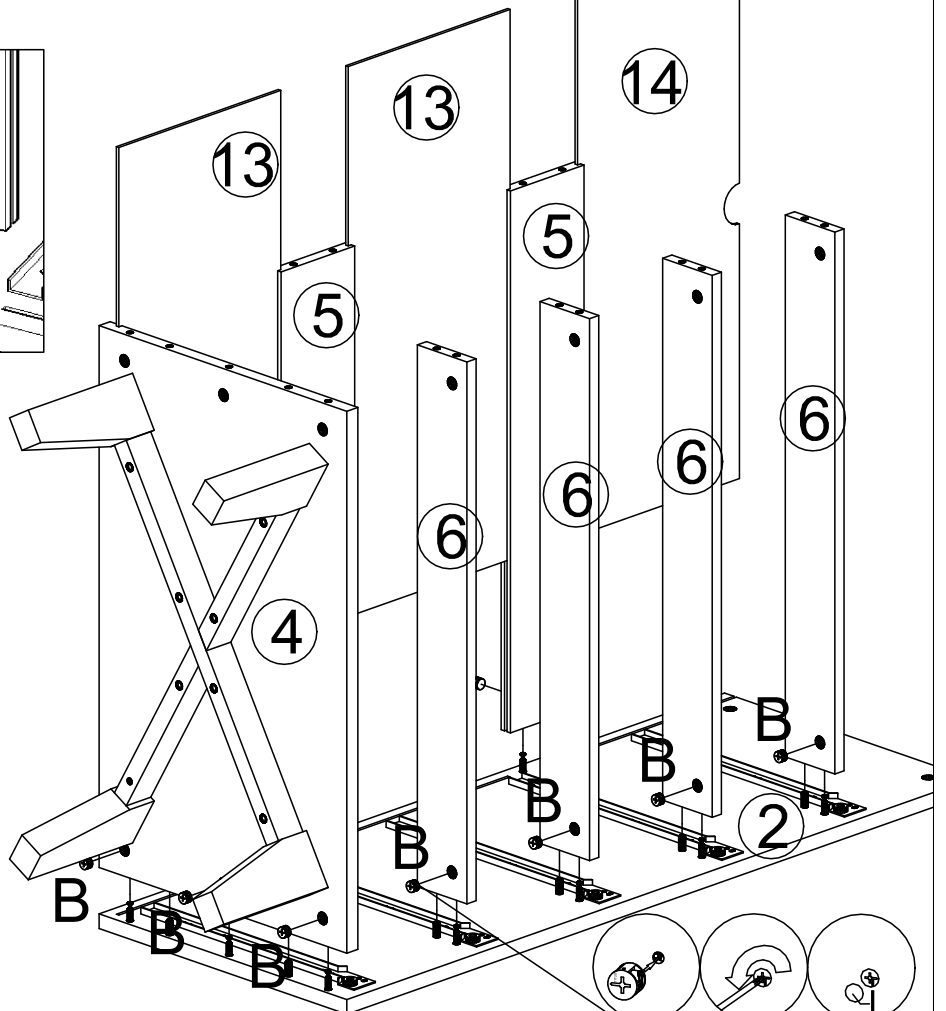
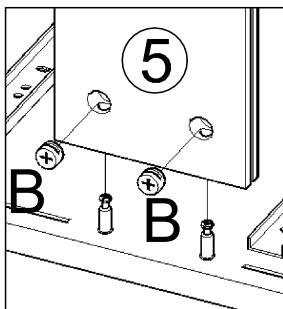
**B**

11pcs

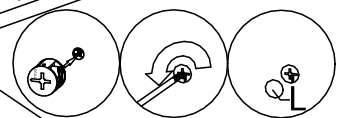

L

11pcs



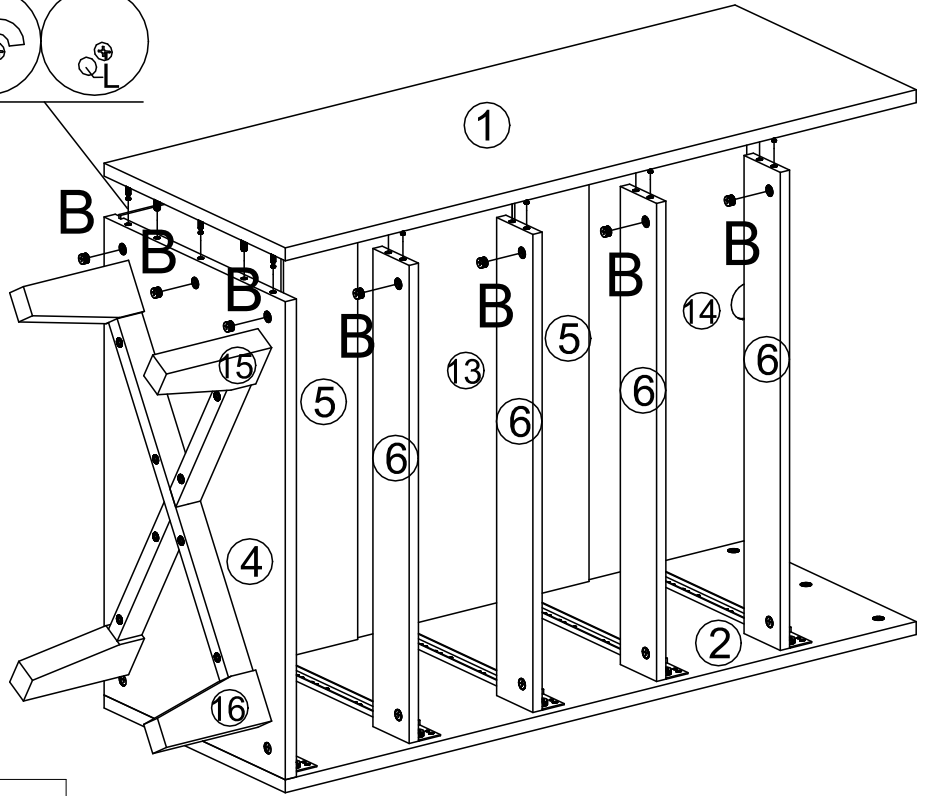
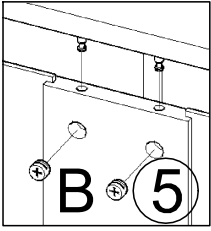
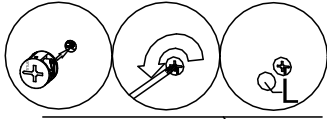

5

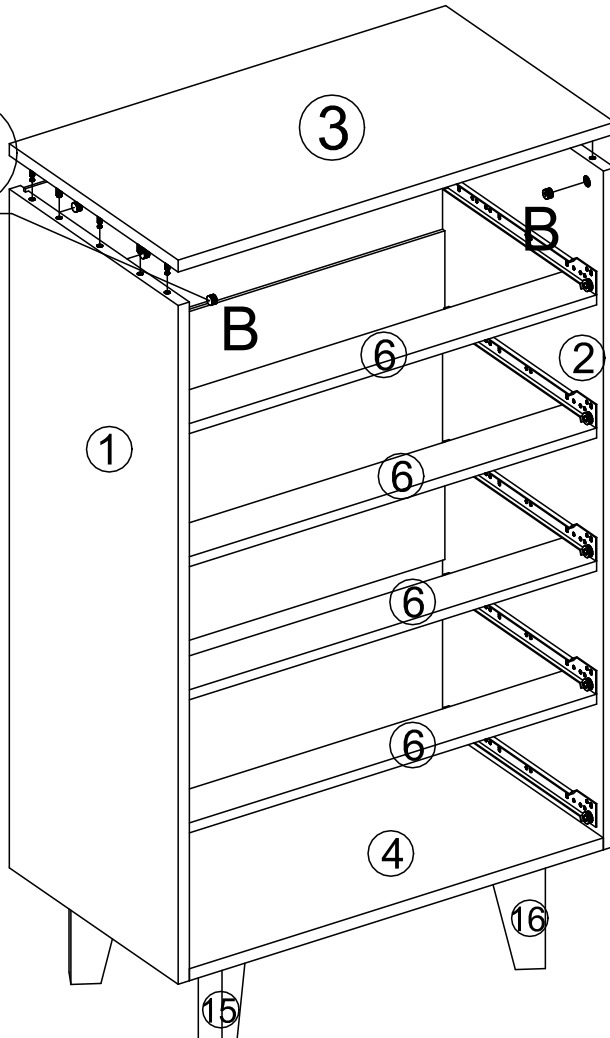
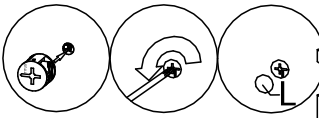

B  11pcs	L  11pcs
--	---

6



B  6pcs	L  6pcs
---	---

7

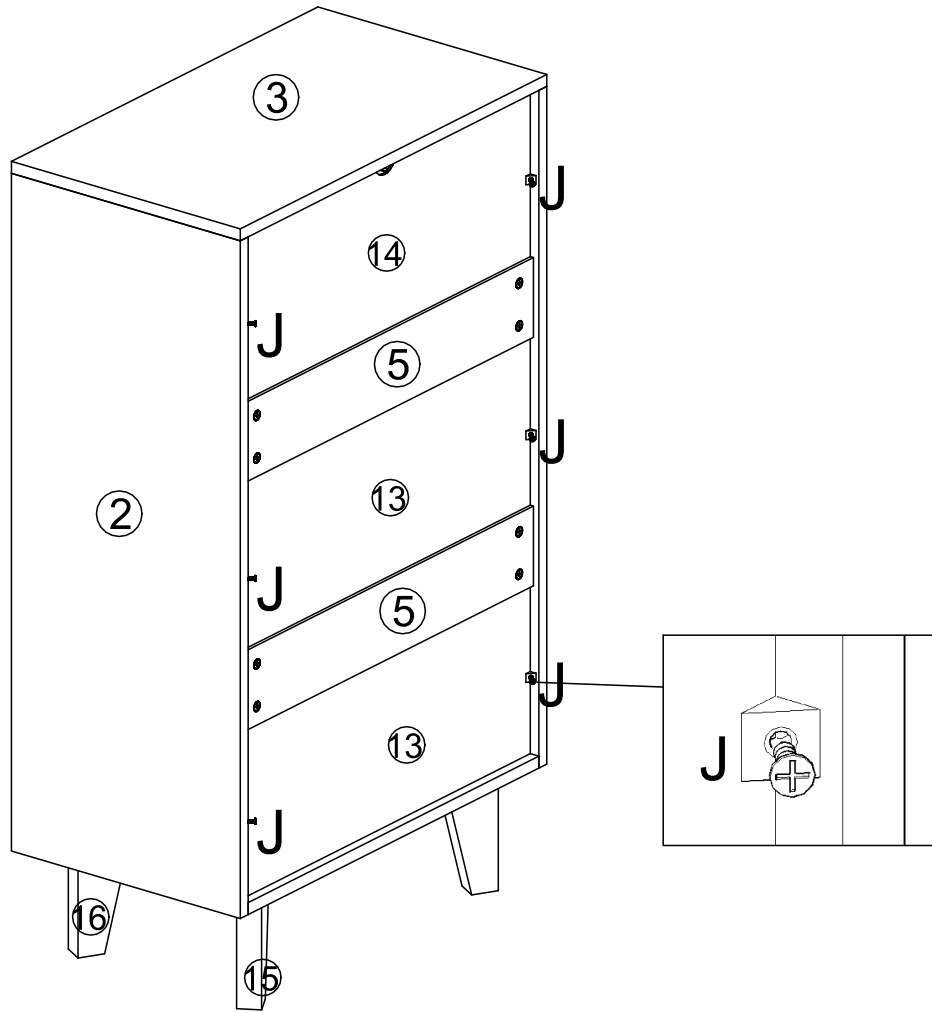

J



6pcs

8

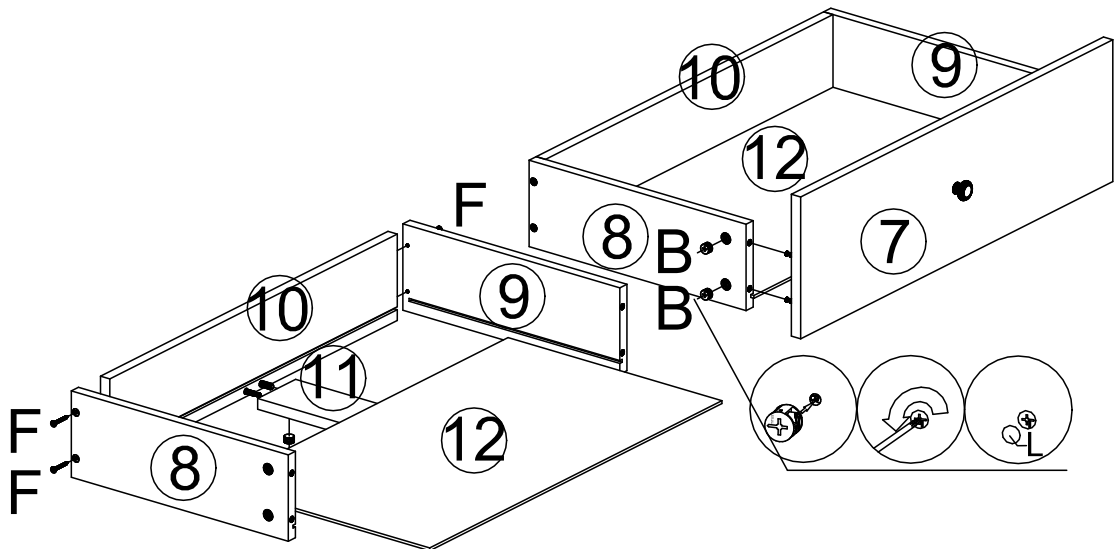

B



30pcs

F



20pcs

L



30pcs

x5

9

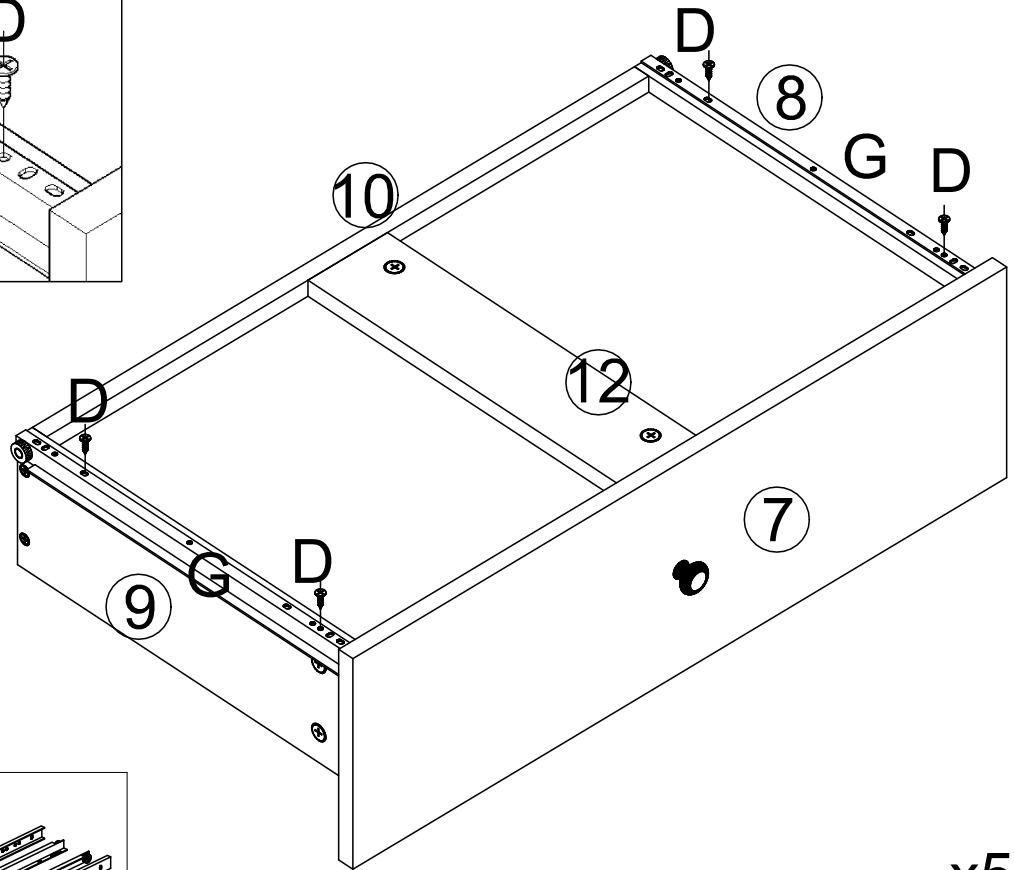
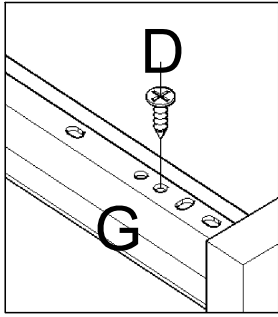

D



M3.5*14

20pcs

G

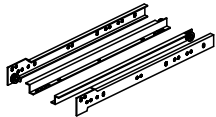

5pcs

x5

10

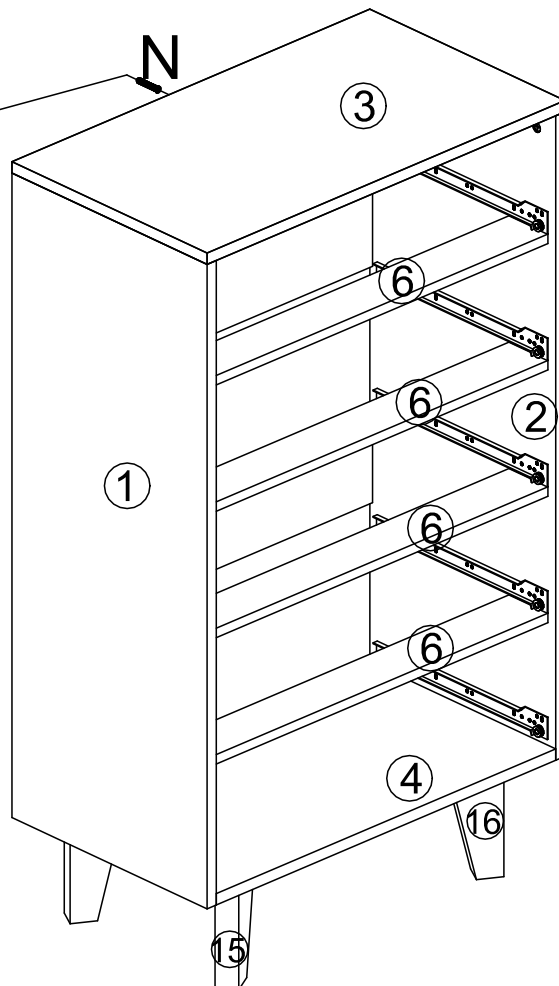
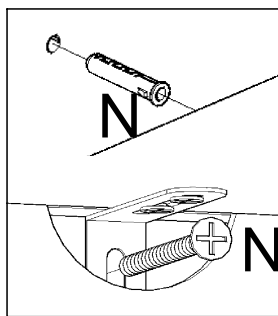

N



1pc

11

