

TIMBERLAKE

PLAYHOUSE

MODEL: # 65314



WARNING

Adult Assembly Required.

The assembly manual must be retained since it contains important information
Not suitable for children under two years due to sharp points and small parts.
FOR DOMESTIC USE ONLY. INTENDED FOR OUTDOOR USE.



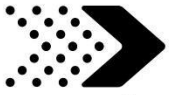

Protrusion Hazard

Incorrect

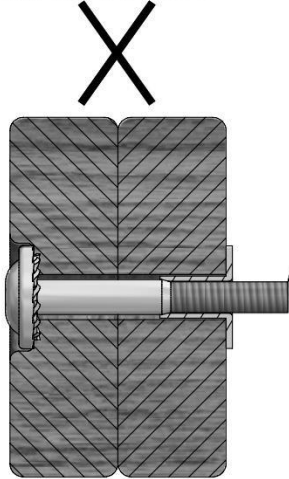

If you see exposed threads and your bolt protrudes beyond the T-Nut you may have over tightened the bolt or used incorrect hardware. If you've overtightened, remove the bolt and add washers to eliminate the protrusion.

Correct

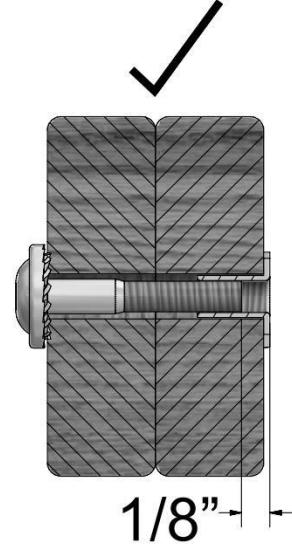

Proper Hardware Assembly

Bolt and T-Nut Assembly

Tap T-nut into the provided hole. Insert your bolt through the lock washer and insert into the provided hole opposite from the T-Nut. Turn clockwise to thread into T-nut. Do not completely tighten until instructed.

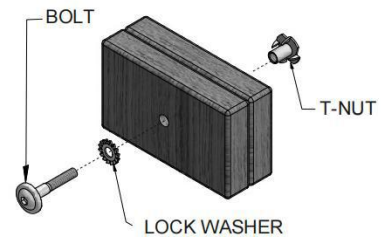

Bolt and Barrel Nut Assembly

Insert barrel nut through the lock washer and press the pair through the provided hole. Insert your bolt through the second lock washer and insert the pair into the provided hole opposite from the barrel nut. Turn clockwise to thread into the barrel nut. Do not completely tighten until instructed.

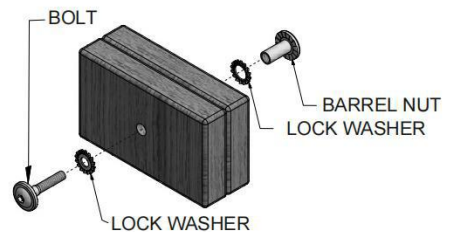

Lag Assembly

Normally there will be a pre-drilled pilot hole on assemblies that require a Lag Screw. If there is no pilot hole, line up the two boards as they are to be attached and use the factory drilled hole as a guide to drill another pilot hole into the adjoining board. This will keep the wood from splitting. Only a lock washer is required for steps with Lag Screws.

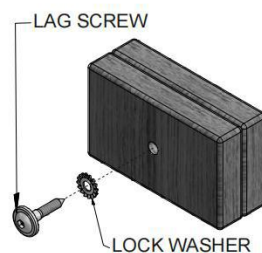



ASSEMBLY TIP:

Keep an eye out for these boxes which will contain helpful pictures and information making the assembly process as quick and painless as possible.

Sorting Wood



When removing the wood from the boxes we recommend arranging them by part number before you begin assembly. This will allow for faster assembly and easily identify any parts that may be missing or damaged.

Sorting Hardware

NUT BARREL
H100545



SCREW
H100695



T-NUT
H100699

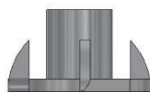

WASHER FLAT
H100706

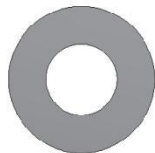

BOLT HEX
H100716



BOLT
H100718



SCREW PWH
H100742



To help with assembly we recommend sorting your hardware bags with the seven digit alpha-numeric number printed on the bags or by hardware type (i.e. bolts, nuts, etc.). Organizing your hardware will make assembly easier.

Hardware Identification

Hardware bags are printed with a seven digit alpha-numeric part number. During assembly you only need to reference the last three digits of the part number as noted in each step. This will make finding the correct hardware easier.

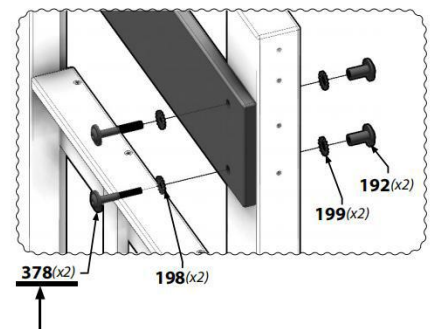
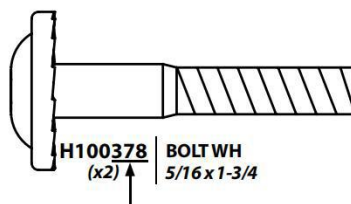

Tools Required for Installation:

(These are the tools that are generally required for assembly of our outdoor products. These tools are not included with the outdoor product purchase.)



(Level 24")

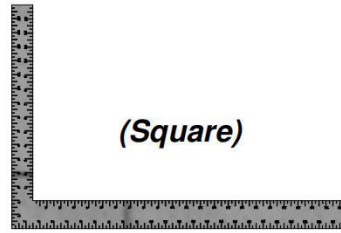

(Square)

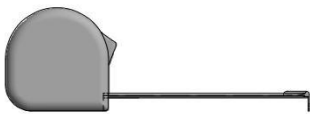

(Tape Measure)



(Phillips Screw Driver)



(Claw Hammer)

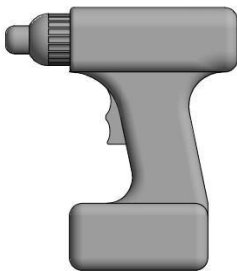

(Cordless Drill or Electric Drill)



***(Drill Attachments:
Phillips Head)***



(Rubber Mallet - Optional)



(An Adult w/ an Adult Helper)



(Ladder)

SAFETY AND ASSEMBLY INFORMATION

SELECTING THE CORRECT LOCATION FOR YOUR PLAY PRODUCT IS IMPORTANT FOR YOUR CHILDREN'S SAFETY AND THE PRODUCT'S LONGEVITY

Dimensions:

• The Timberlake has one layout option.
 Layout Ground Dimension
 3'-6" x 3'-10 11/16" x 56" Tall

Safe Play Area*
 15'-6" x 15'-10 3/4"

*Level Ground Surface - See below

General Information:

Your set has been designed and engineered for children only and for residential use only.
 A maximum of 150 lbs. per child is recommended for play activities designed for individual use.
 A maximum of 120 lbs. per child is recommended for play activities designed for multiple child use.
 A maximum of 6 children is recommended for this unit.

Safe Play Area:

- The safe play area refers to a zone extending 6' beyond the play product on all sides, including the space above the play product.
- The ground surface **must be level**. Installing your play product on sloping ground can cause it to lean or "rack". This leaning puts additional stress on all connections and joints and in time will cause those connections to loosen and fail.
- The safe play area must be free of all structures, landscaping, trees and branches, rocks, wires, and other obstacles to safe play. Children can be seriously injured running or swinging into these obstacles.
- Remove all tripping hazards from the safe play area. Tripping hazards include: roots, stumps, rocks, landscaping, sprinkler heads, railroad ties, plumbing and electrical connections.
- Play product needs to be installed on solid ground.

SAFE PLAY AREA DIAGRAM

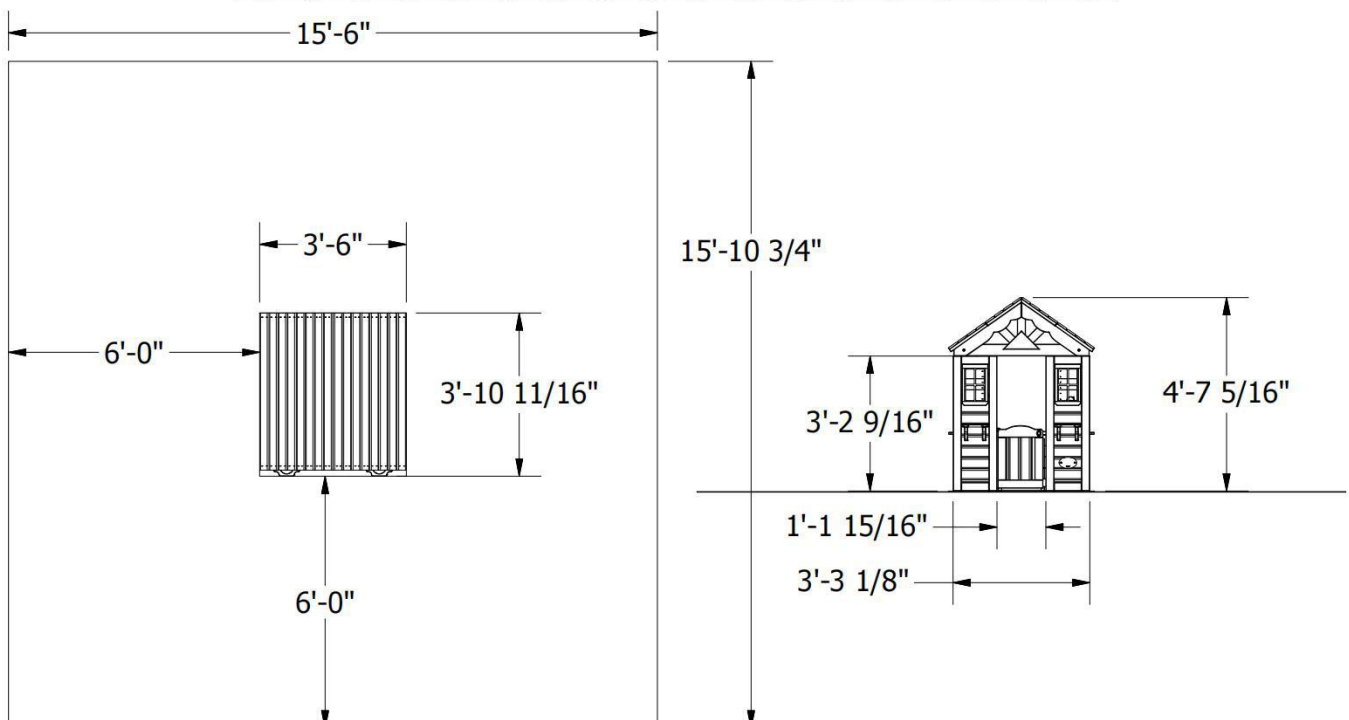

Parts Identification

Wood Components

(NOT TO SCALE)



- (2) **J1 - COUNTER TOP SUPPORT - W4L04753**
 1"x2 3/8"x5 7/8" (24x60x150)

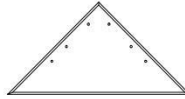

- (2) **K1 - TRIANGLE SUNBURST - W4L04871**
 5/8"x5 1/4"x10 3/8" (16x134x265)

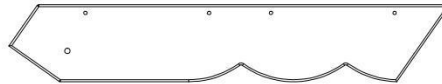

- (4) **L1 - GABLE BOARD - W4L04755**
 5/8"x4 3/8"x25 3/8" (16x112x643)

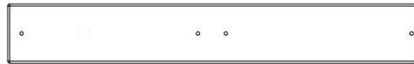

- (2) **M1 - COUNTER TOP - W4L04754**
 5/8"x3 3/8"x36 7/8" (16x86x938)



- (2) **N1 - SIDE WINDOW SHELF - W4L04751**
 5/8"x2 3/8"x18 7/8" (16x60x479)



- (1) **N2 - REAR WINDOW SHELF - W4L04760**
 5/8"x2 3/8"x19 1/8" (16x60x485)



- (1) **N3 - DOOR STOP - W4L04761**
 5/8"x2 3/8"x36 7/8" (16x60x938)



- (8) **N4 - TIE STRAP - W102424**
 5/8"x2"x3 1/8" (16x50x80)



- (2) **N5 - SUNBURST LEG - W4L04872**
 5/8"x2 3/8"x10 1/4" (16x60x260)



- (4) **N6 - SUNBURST LEG - W4L04873**
 5/8"x2 3/8"x8 1/4" (16x60x210)



- (1) **Q1 - COUNTER TOP SUPPORT - W4L04752**
 1"x4 3/8"x5 7/8" (24x112x150)

Parts Identification
Wood Components
(NOT TO SCALE)

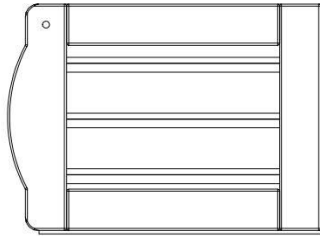

(1) DP1 - DOOR ASSEMBLY - W2A01511

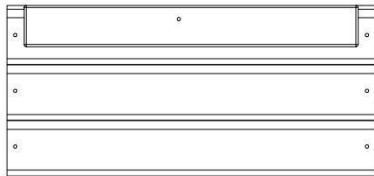

(1) WP7 - UPPER REAR CENTER WALL
 - W2A01522

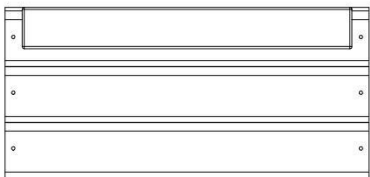

(2) WP6 - UPPER CENTER WALL
 - W2A01510

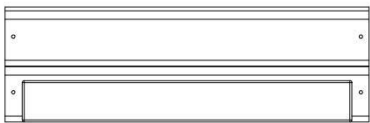

(2) WP5 - LOWER CENTER WALL
 - W2A01509

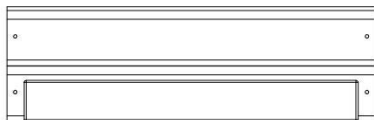

(1) WP8 - LOWER REAR CENTER WALL
 - W2A01523

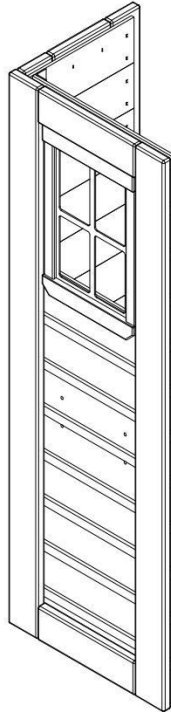

(1) WP1 - LEFT FRONT CORNER PANEL
 - W2A01524

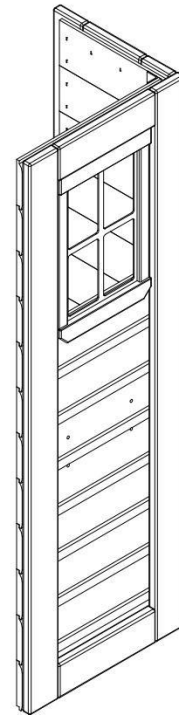

(1) WP2 - RIGHT FRONT CORNER PANEL
 - W2A01525

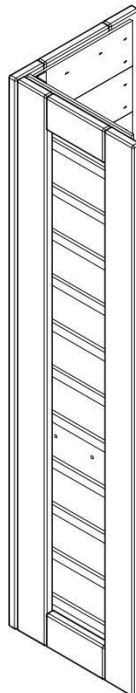

(1) WP3 - LEFT REAR CORNER PANEL
 - W2A01526

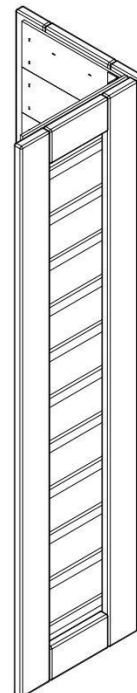

(1) WP4 - RIGHT REAR CORNER PANEL
 - W2A01527

Parts Identification
Wood Components
(NOT TO SCALE)

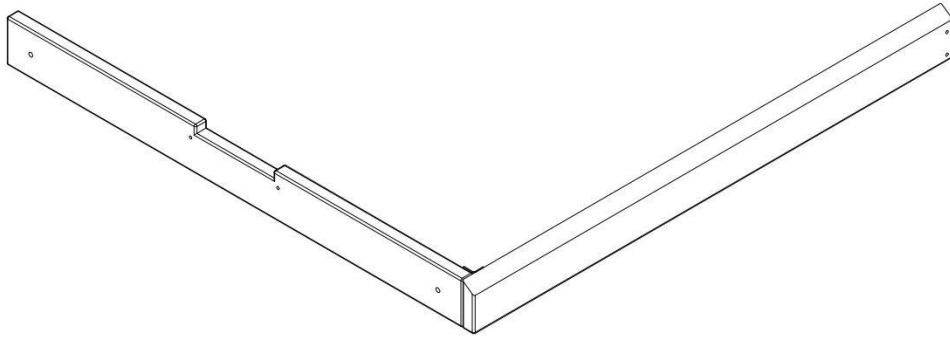

(2) WP9 - HEADER ASSEMBLY - W2A01539

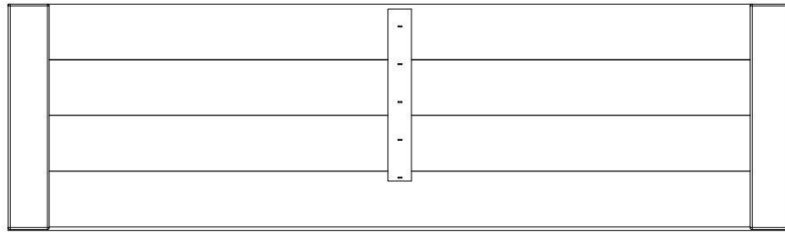

(2) RP1 - LOWER ROOF PANEL - W2A01513

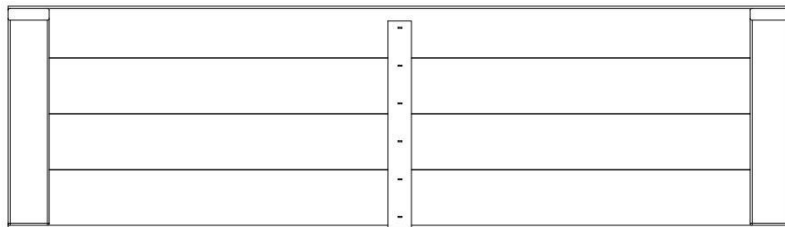

(2) RP2 - UPPER ROOF PANEL - W2A01514

Parts Identification

Hardware



(8) SCREW PFH 8x1/2 - H100124 (ST4*15)

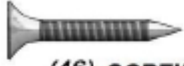

(46) SCREW PFH 8x1 - H100085 (ST4*25)



(20) SCREW PFH 8x1 1/8 - H100088 (ST4*30)



(52) SCREW PFH 8x1 1/4 - H100087 (ST4*35)



(20) SCREW PFH 8x1 1/2 - H100086 (ST4*40)



(1) SCREW PFH 8x2 - H100111 (ST4*50)



(4) SCREW PFH 8x2 1/2 - H100090 (ST4*60)



(48) SCREW PWH 8x3/4 - H100070 (ST4*20)

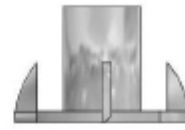

(4) NUT BARREL WH 1/4x7/8 - H100140 (1/4-20*9)



(4) BOLT WH 1/4x1 1/2 - H100137 (1/4-20*1-1/2)



(4) WASHER LOCK EXT 8x15 - H100139 (Φ8)



(4) WASHER LOCK EXT 6x15 - H100138 (Φ6)



(2) T-30 TORX BIT - H100147 (T40*50.5)

(2) T-30 TORX WRENCH - H100114 (T40*73)

Parts Identification
Accessories
(NOT TO SCALE)

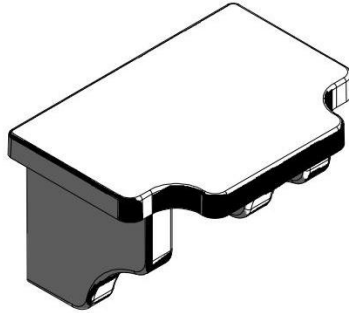

(2) FLOWER POT HOLDER - A6P00023

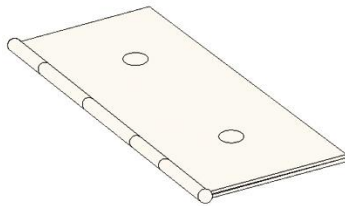

(2) HY1



A100071 | HZ-KNOB
(x1)

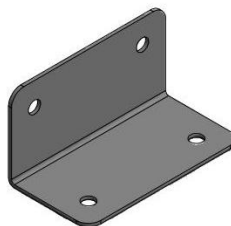

(12) GD - L BRACKET

Playhouse Assembly

STEP 1:

STAND THE (4) CORNER WALL ASSEMBLIES AS SHOWN BELOW.



(12) GD - L BRACKET

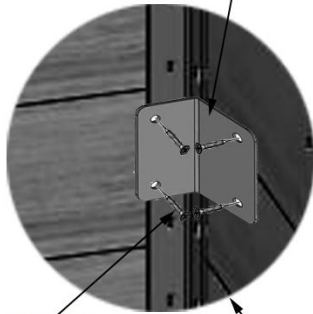

SCREW PWH
8x3/4

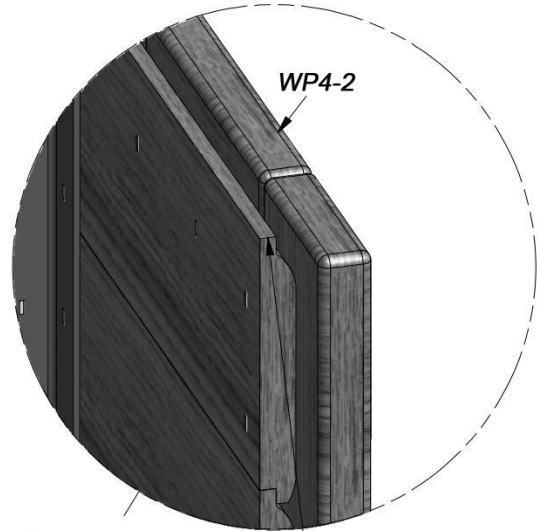

NOTE THE PROFILE OF
THE WALL BOARDS.
THE TONGUE FACES
TOWARD THE TOP OF
THE PANELS.

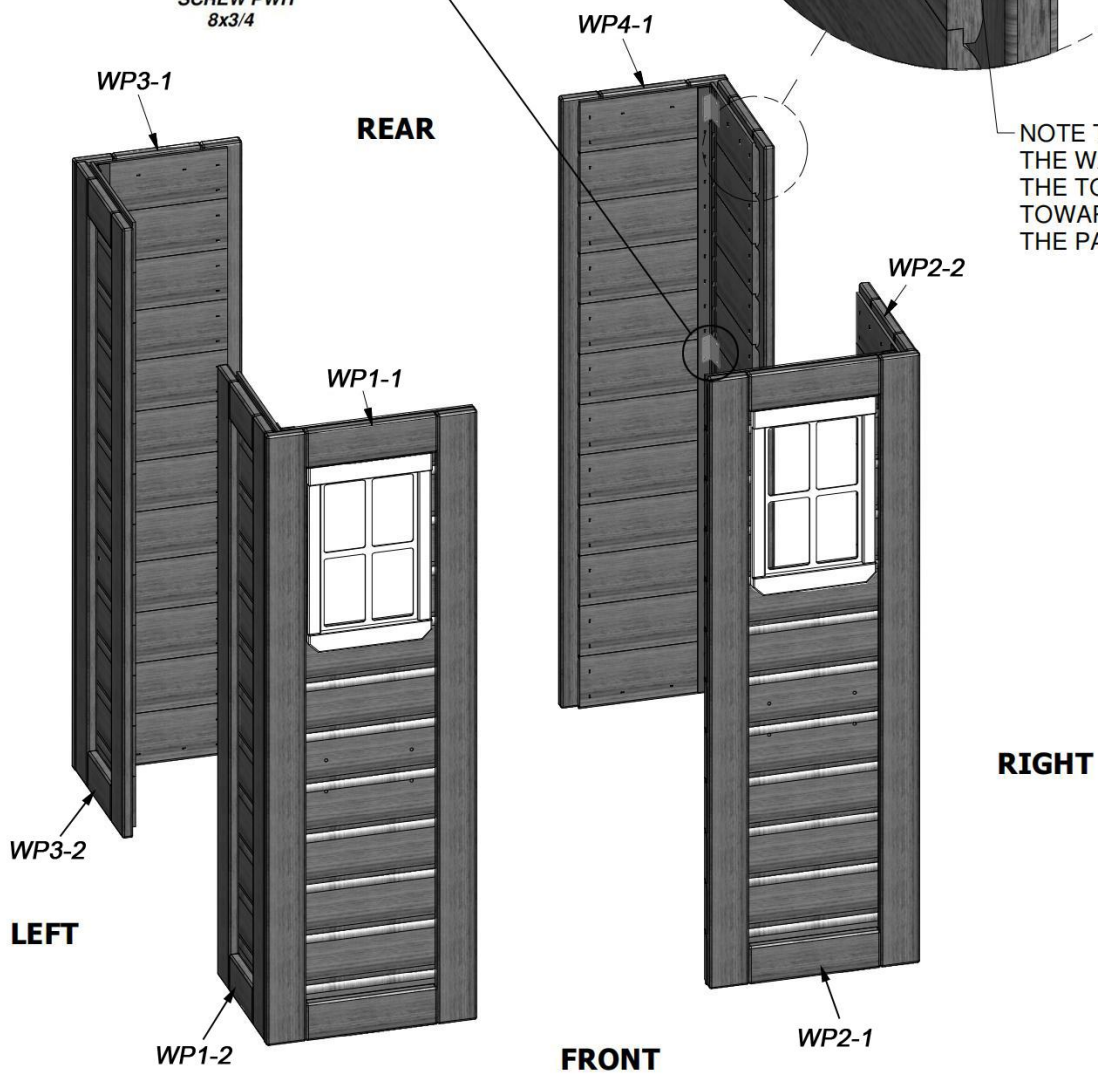

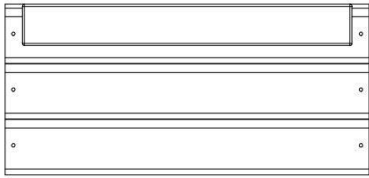

(1) WP6 - UPPER CENTER WALL
- W2A01510

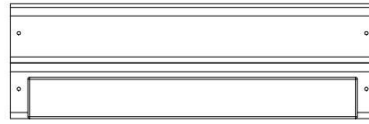

(1) WP5 - LOWER CENTER WALL
- W2A01509

STEP 2:

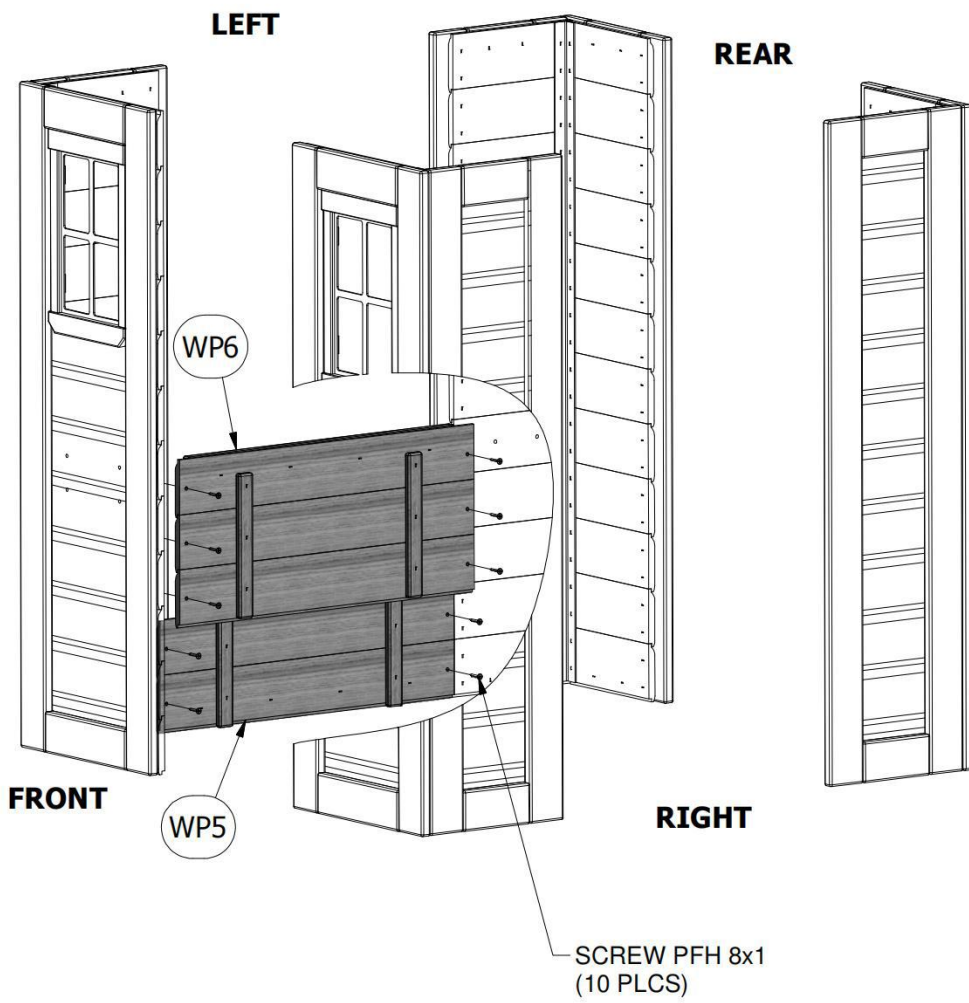
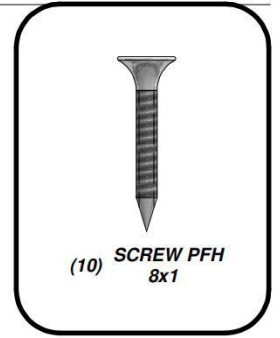

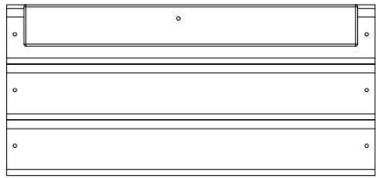

(1) WP7 - UPPER REAR CENTER WALL
- W2A01522

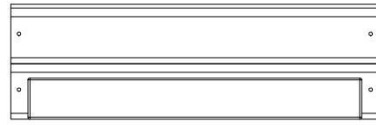

(1) WP8 - LOWER REAR CENTER WALL
- W2A01523

STEP 3:

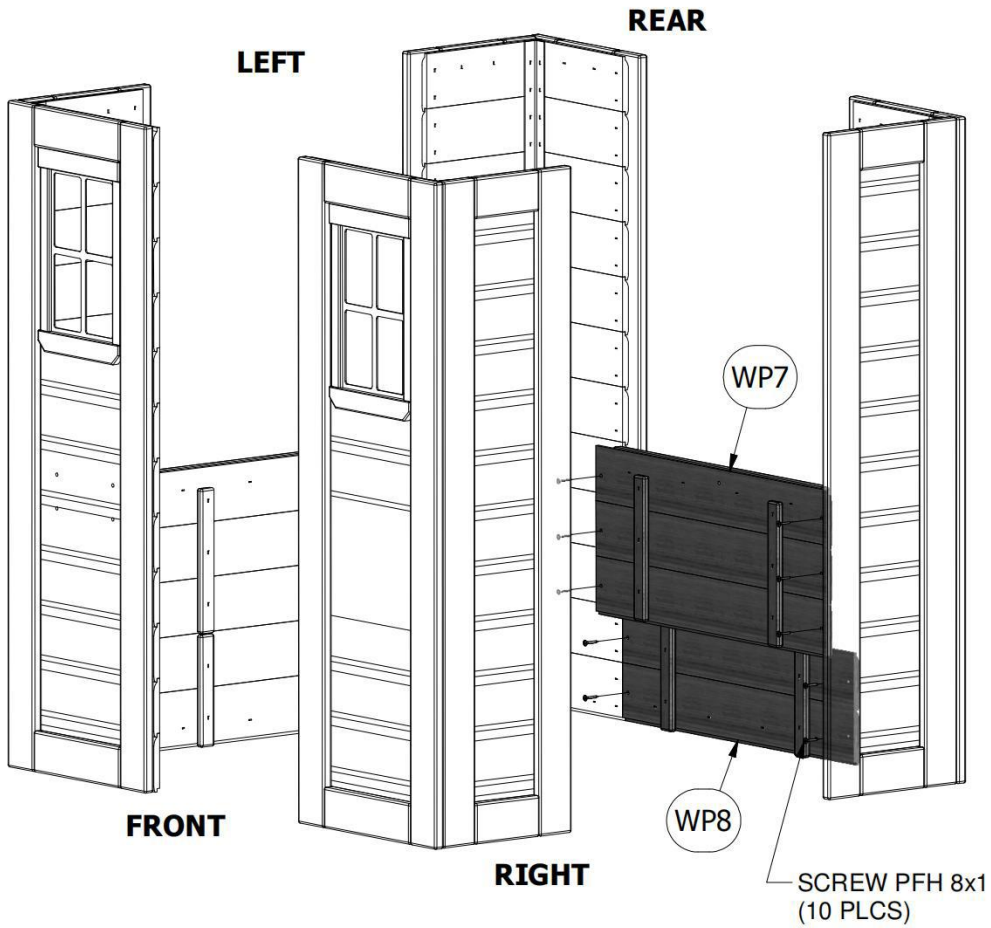
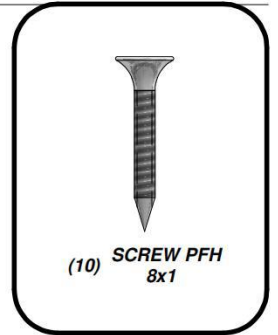

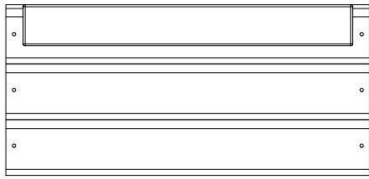

(1) WP6 - UPPER CENTER WALL
- W2A01510



(1) WP5 - LOWER CENTER WALL
- W2A01509

STEP 4:

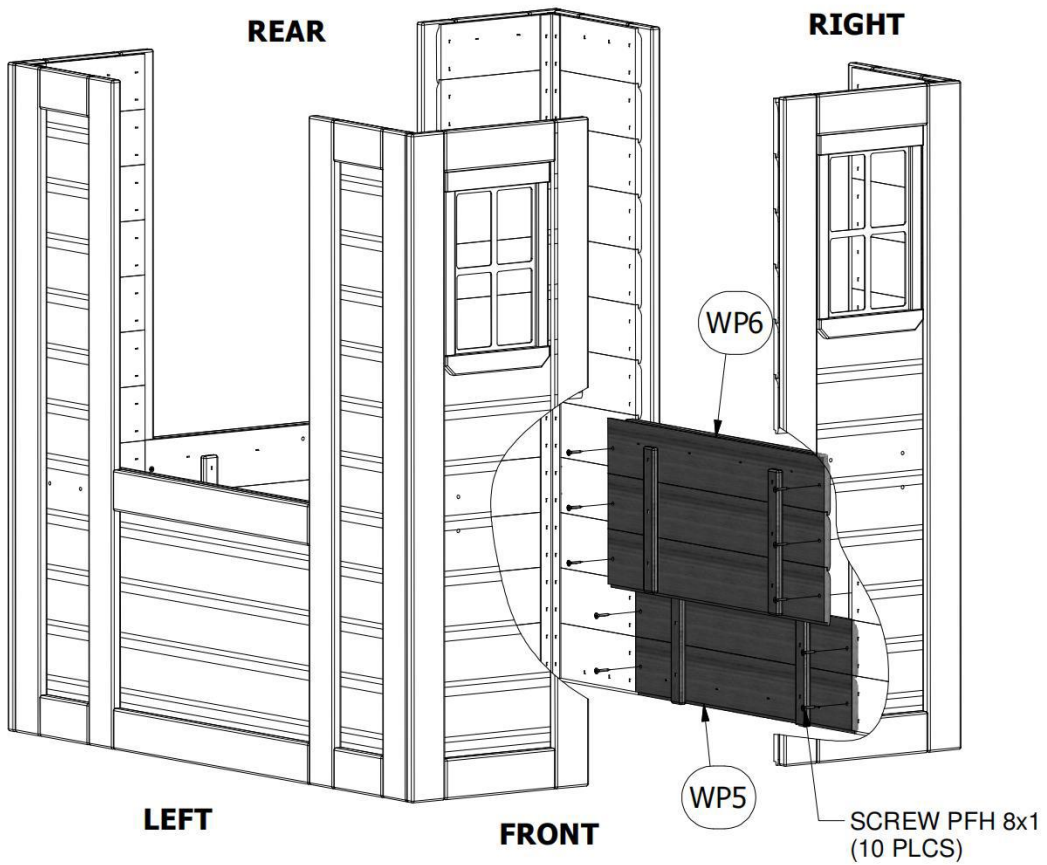
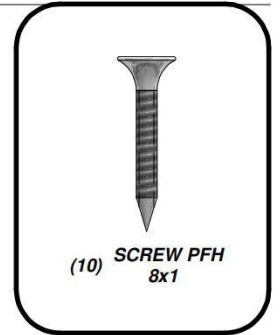

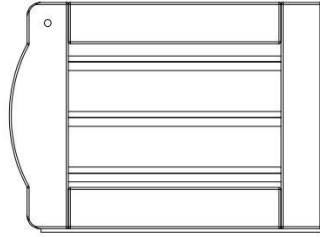

(1) DP1 - DOOR ASSEMBLY - W2A01511



(2) HY1

STEP 5:

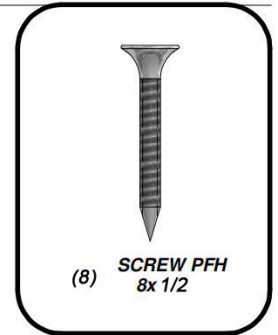
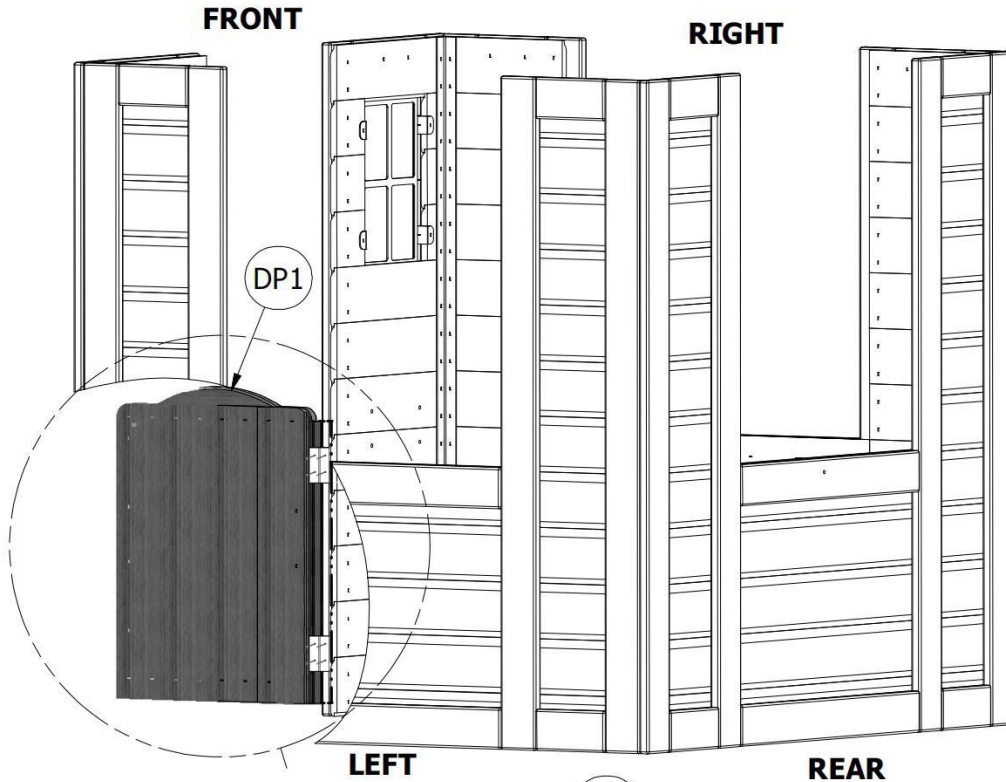

(8) SCREW PFH
8x 1/2

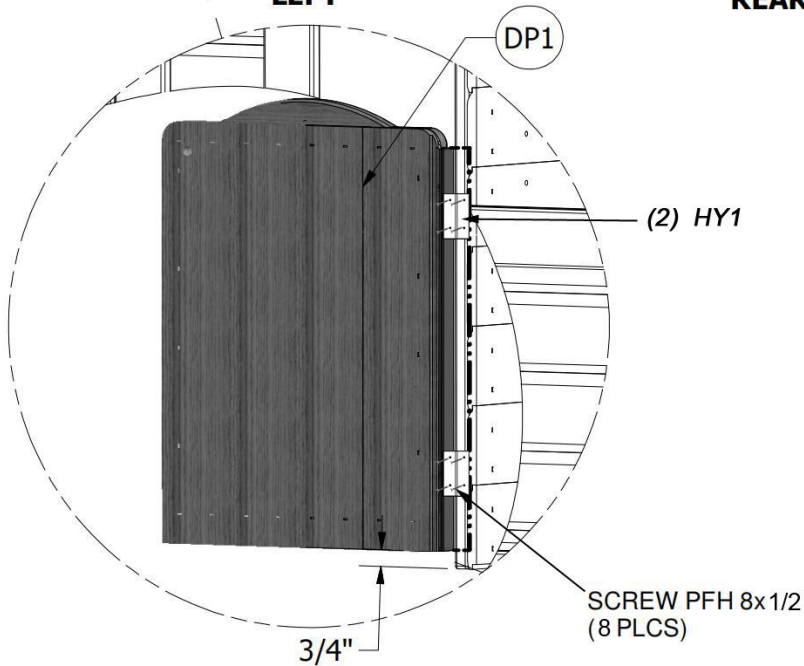

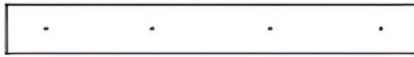

(1) **N3 - DOOR STOP - W4L04761**
5/8"×2 3/8"×36 7/8"(16×60×938)

STEP 6:

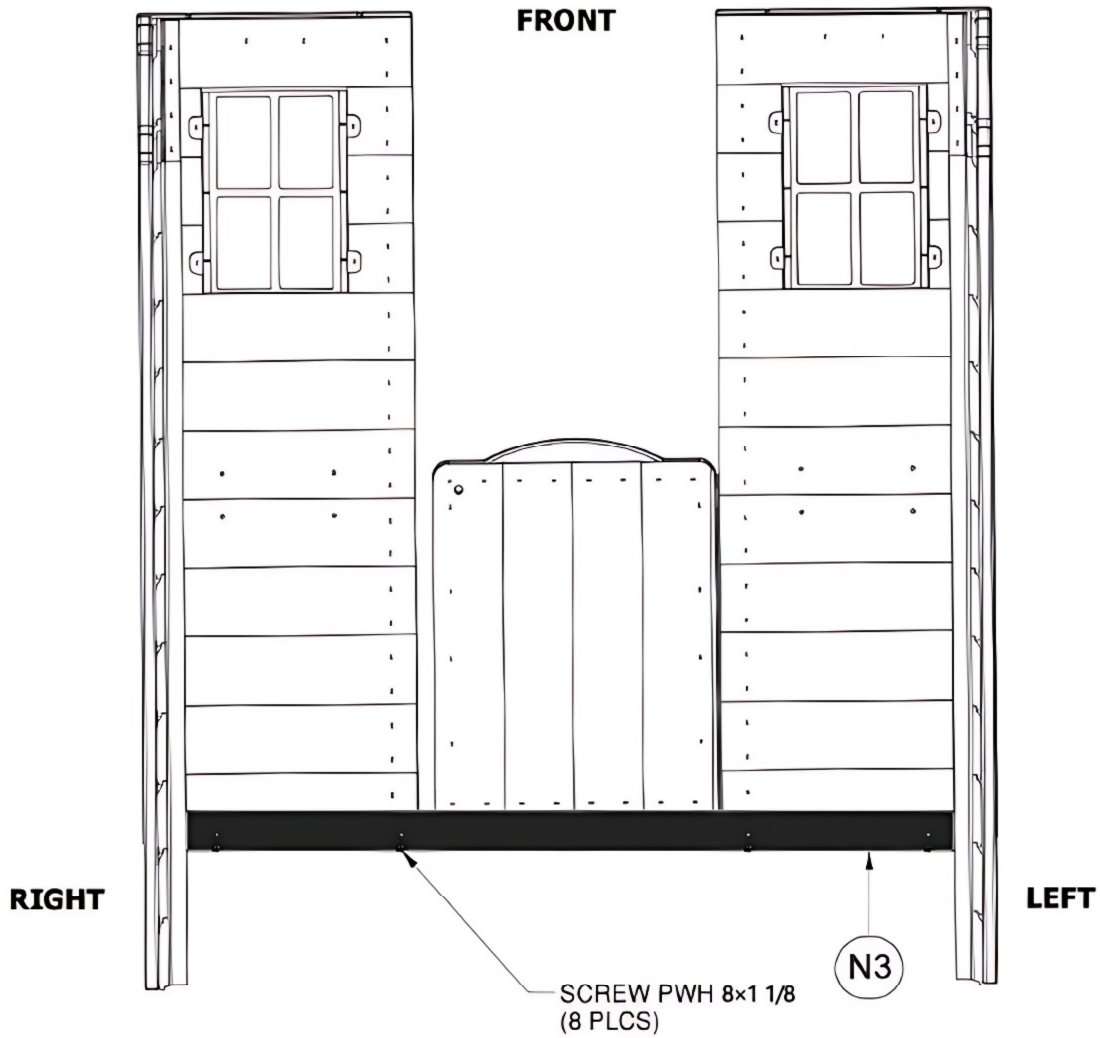

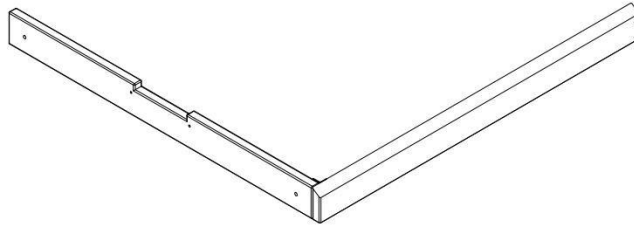

(2) WP9 - HEADER ASSEMBLY - W2A01512

STEP 7:

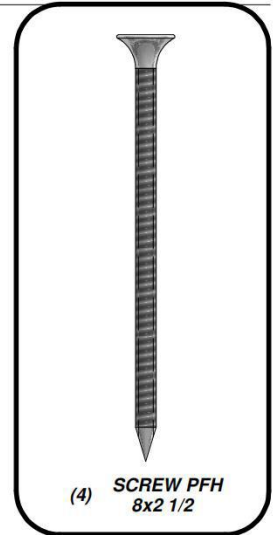
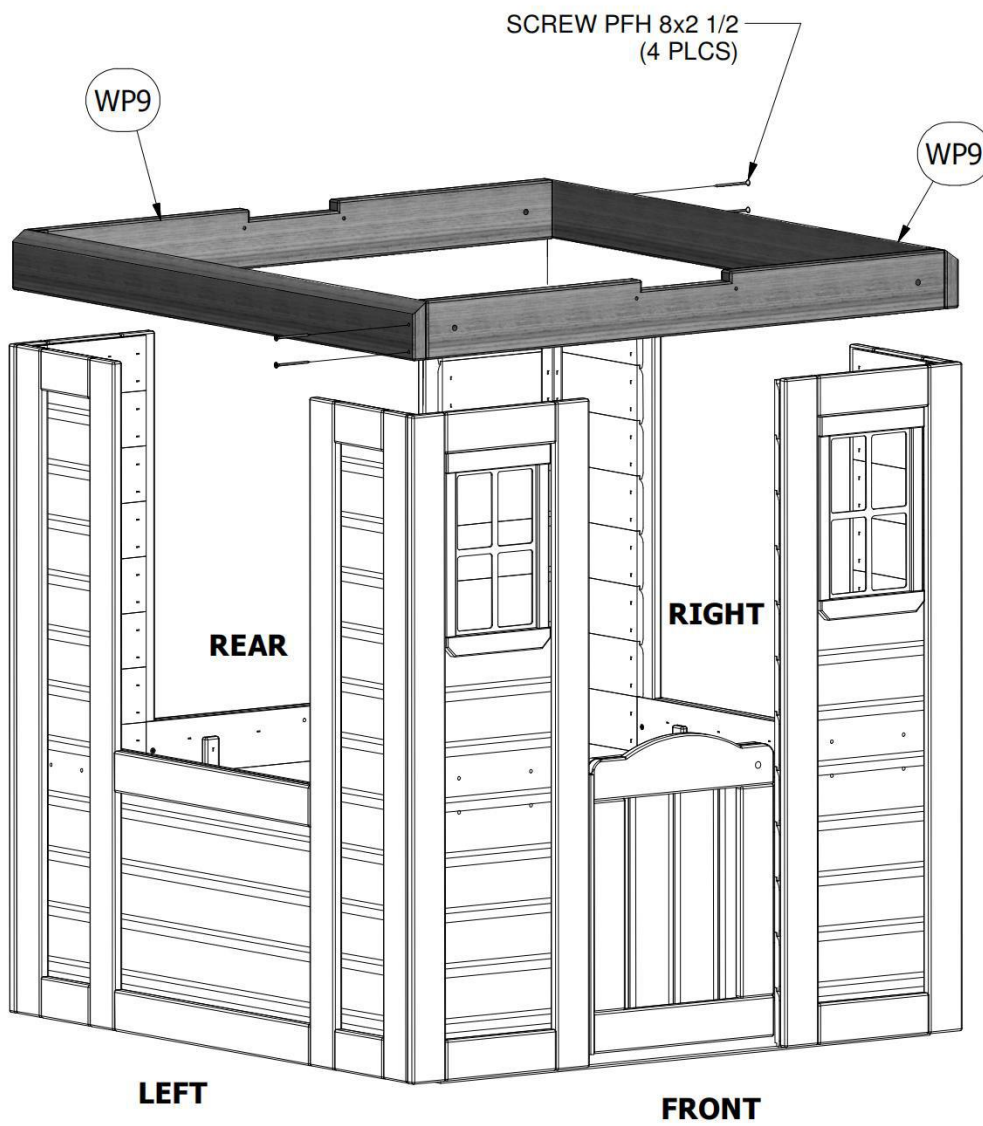

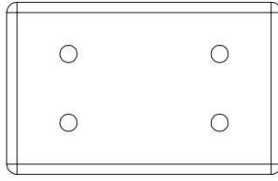

(8) **N4 - TIE STRAP - W102424**
5/8" x 2" x 3 1/8" (16x50x80)

STEP 8:

SCREW PFH 8x1 1/4
(32 PLGS)

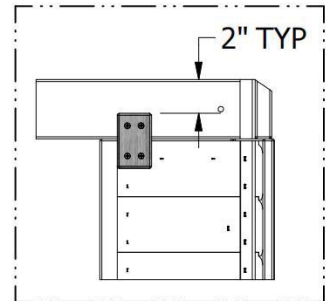
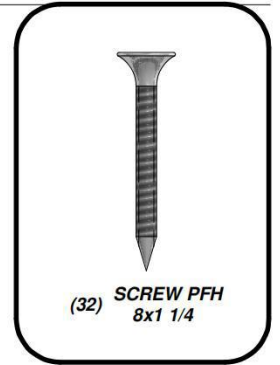
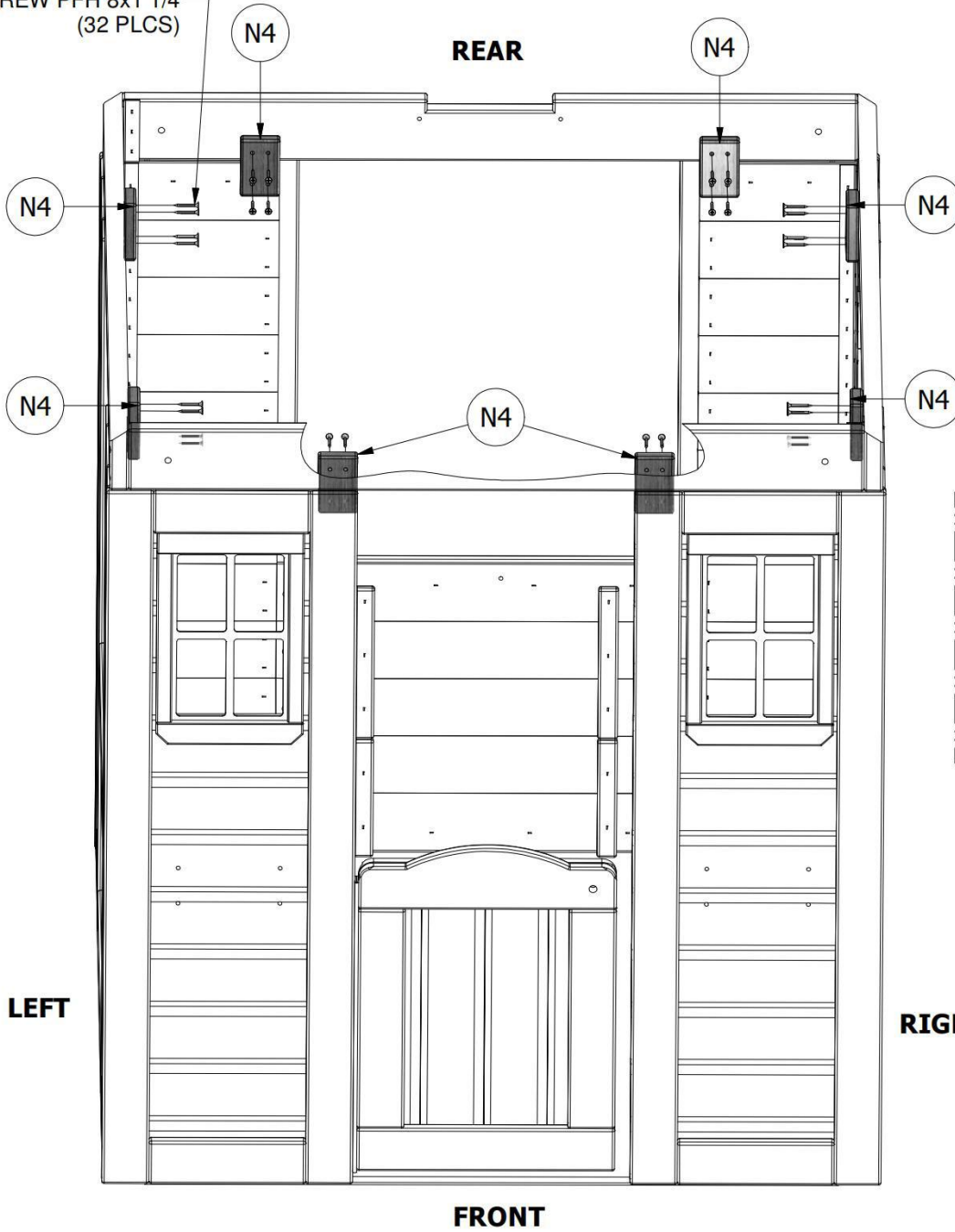

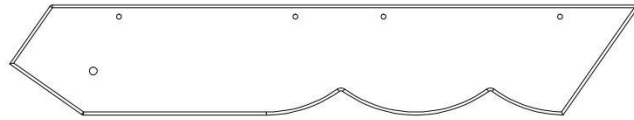

(4) **L1 - GABLE BOARD - W4L04755**
5/8"x4 3/8"x25 3/8" (16x112x643)

STEP 9:

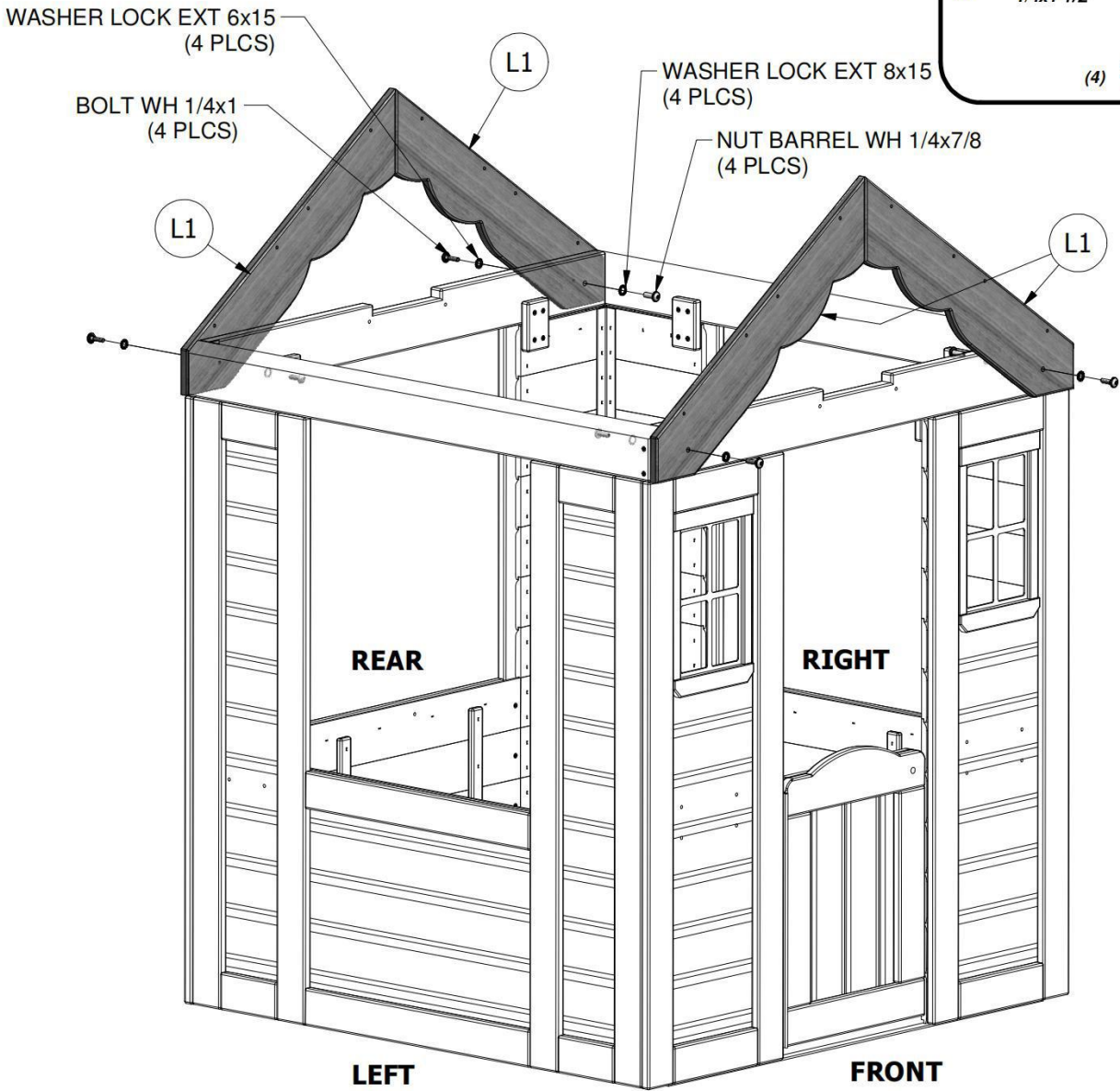
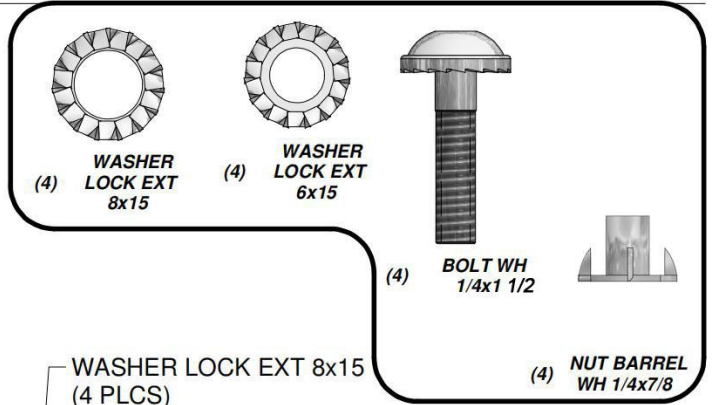

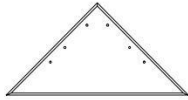

(2) **K1 - TRIANGLE SUNBURST - W4L04871**
 5/8"x5 1/4"x10 3/8" (16x134x265)



(2) **N5 - SUNBURST LEG - W4L04872**
 5/8"x2 3/8"x10 1/4" (16x60x260)



(4) **N6 - SUNBURST LEG - W4L04873**
 5/8"x2 3/8"x8 1/4" (16x60x210)

STEP 10:

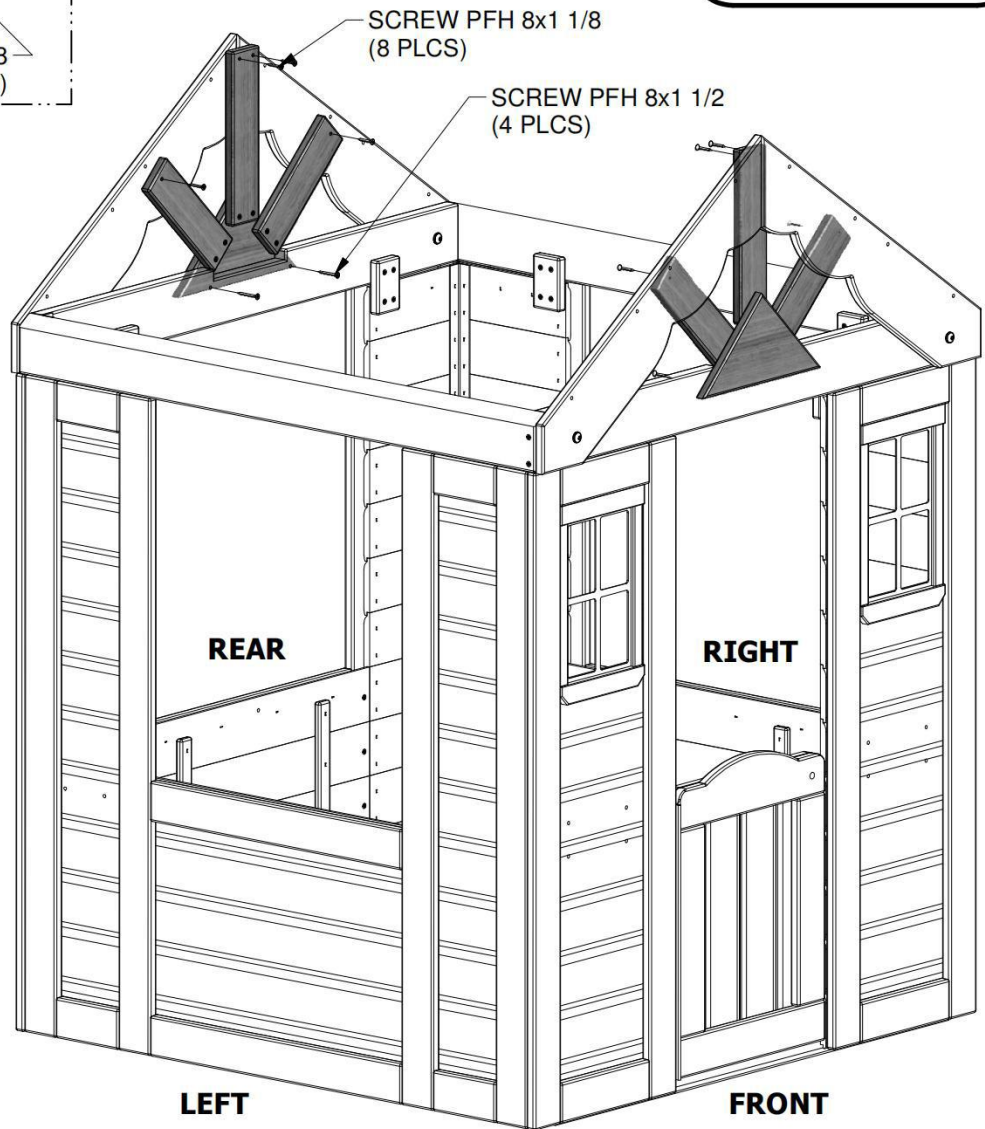
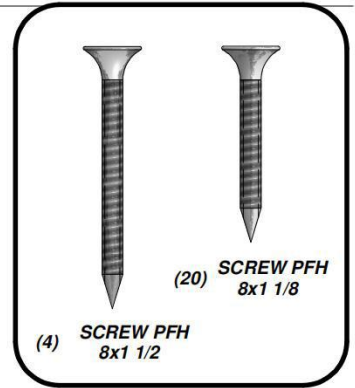
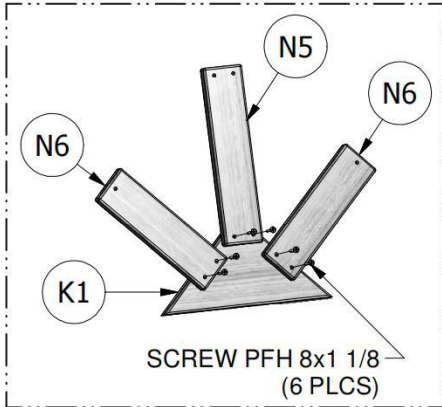

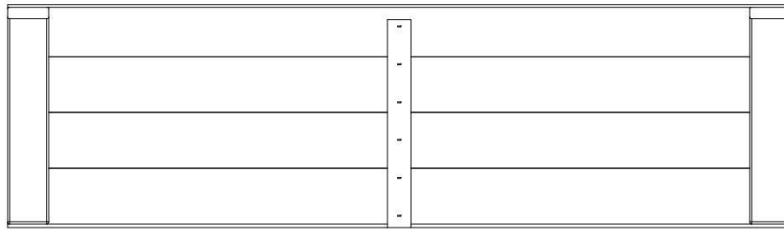

(2) RP2 - UPPER ROOF PANEL - W2A01514

STEP 11:

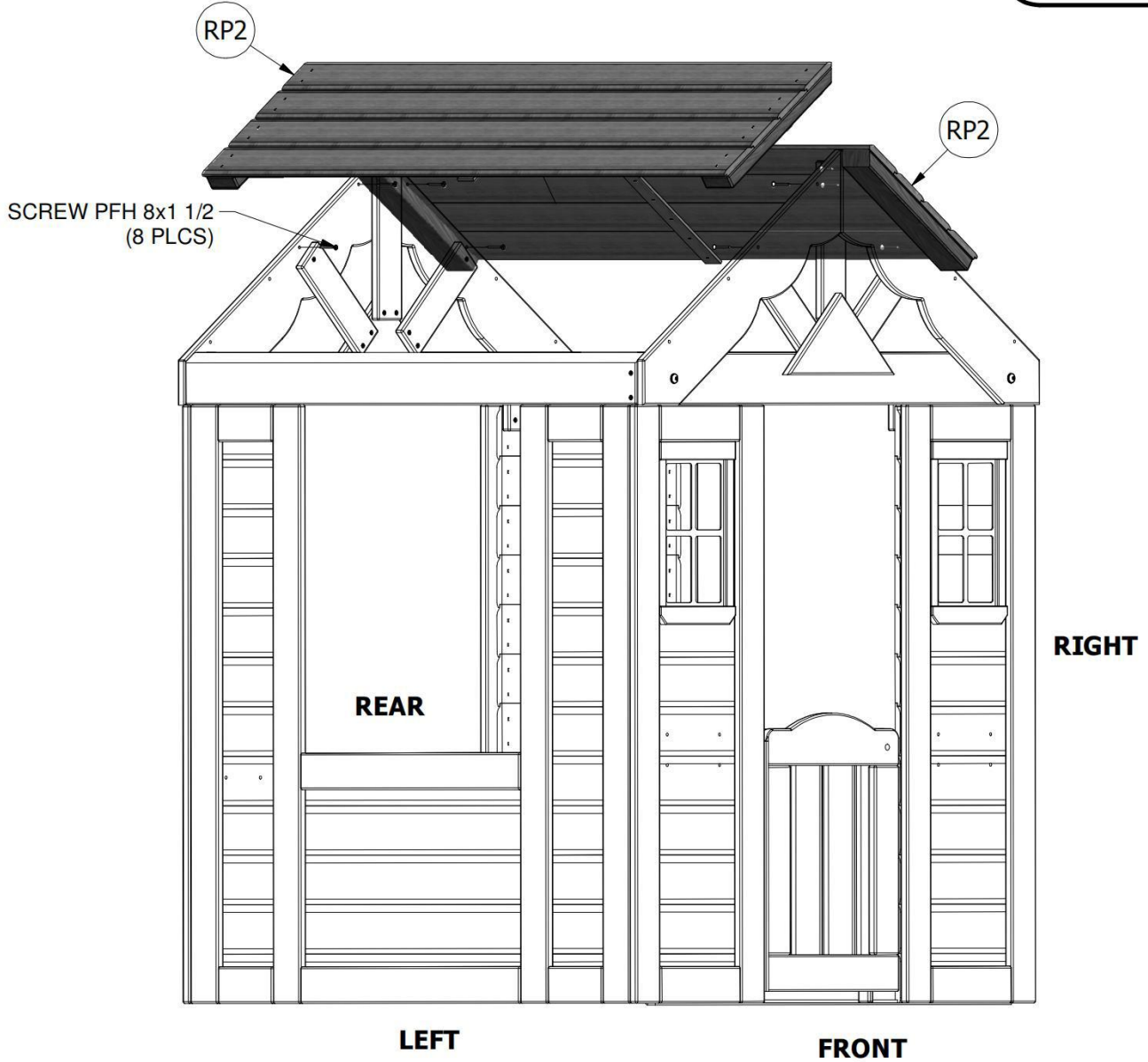
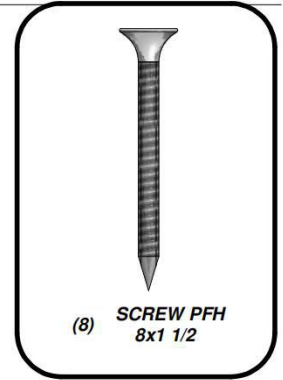
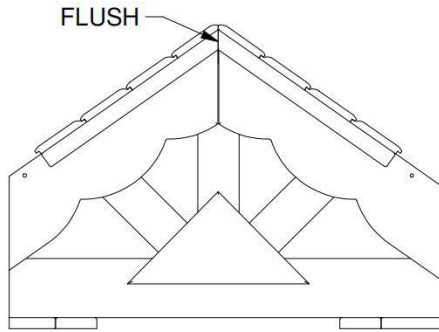

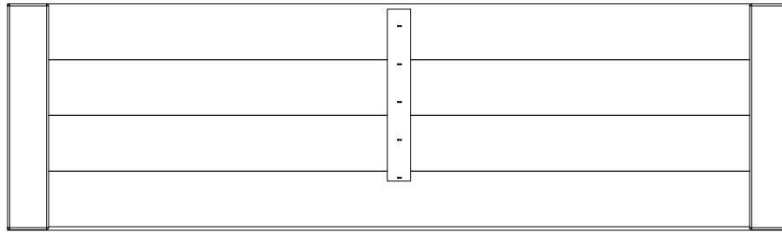

(2) RP1 - LOWER ROOF PANEL - W2A01513

STEP 12:

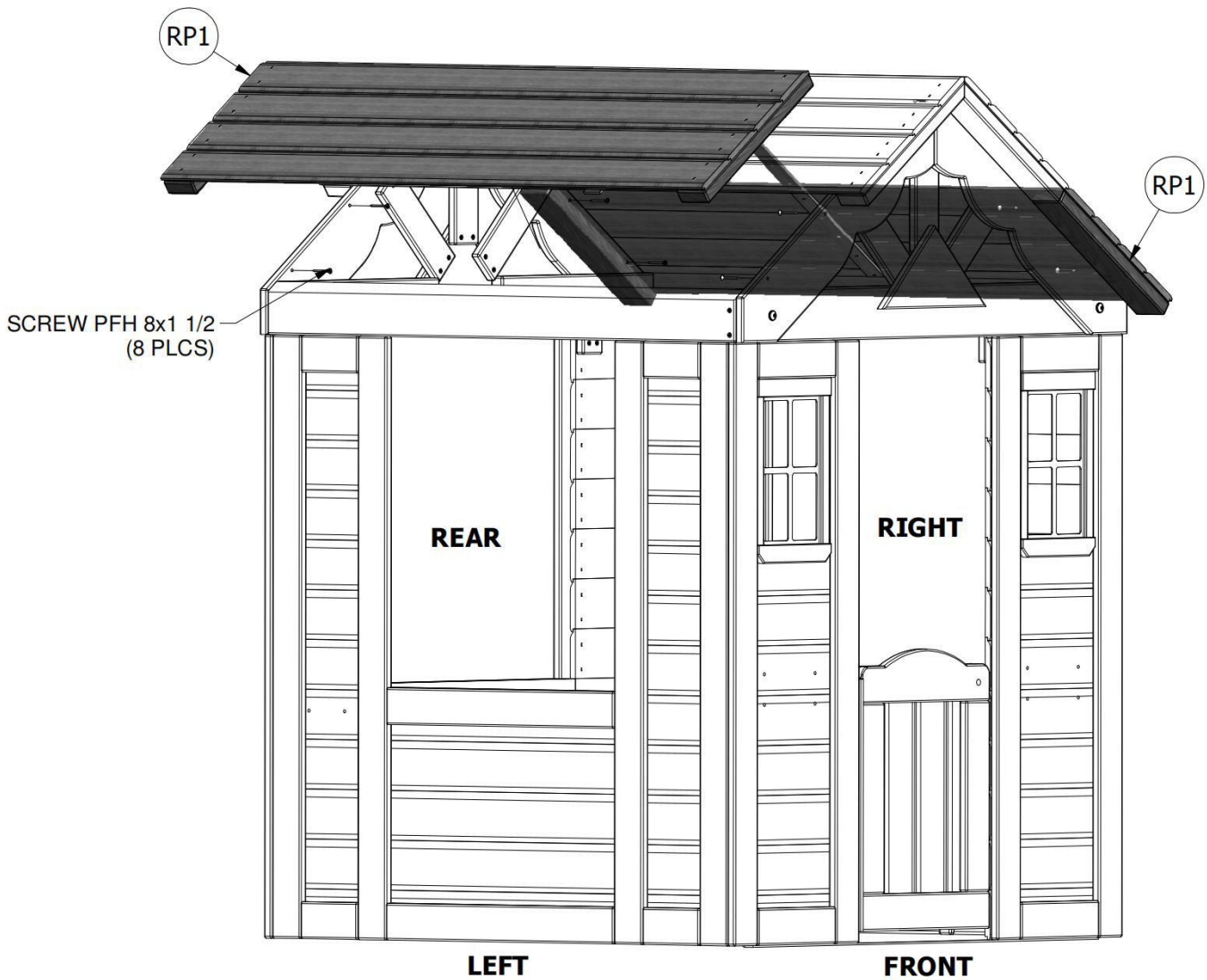
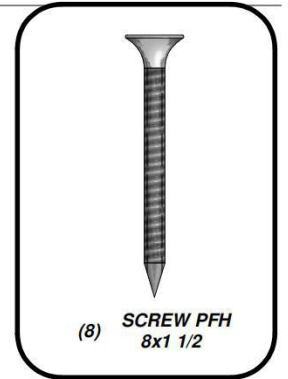



(1) **N1 - SIDE WINDOW SHELF - W4L04751**
5/8"x2 3/8"x18 7/8" (16x60x479)

STEP 13:

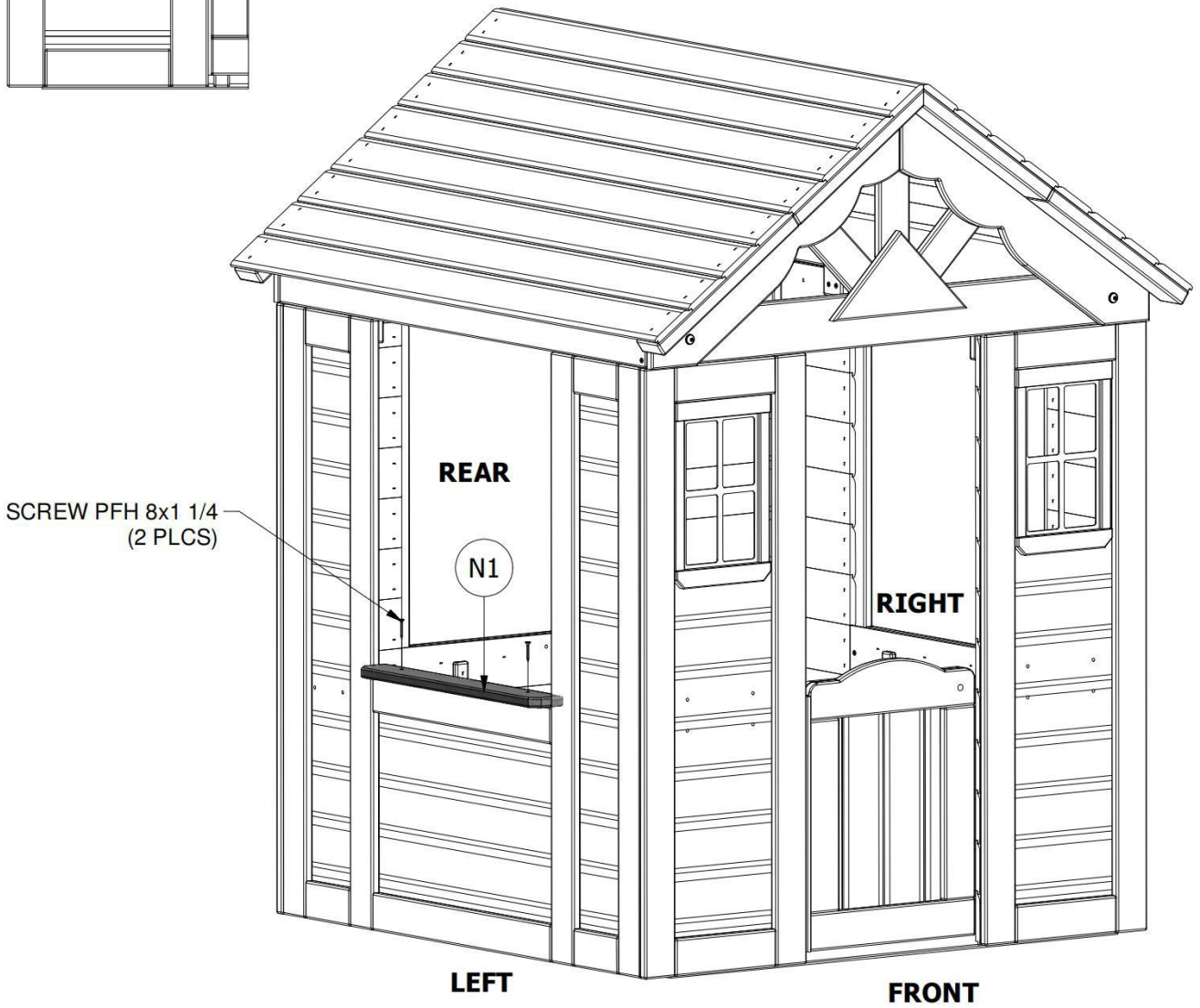
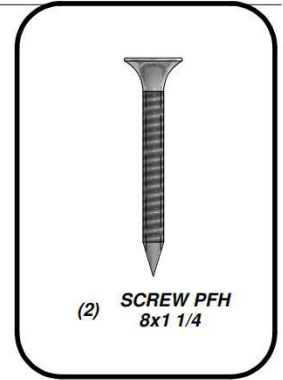
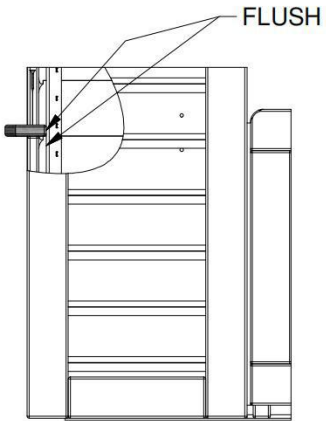



(1) **N2 - REAR WINDOW SHELF - W4L04760**
5/8"x2 3/8"x19 1/8" (16x60x485)

STEP 14:

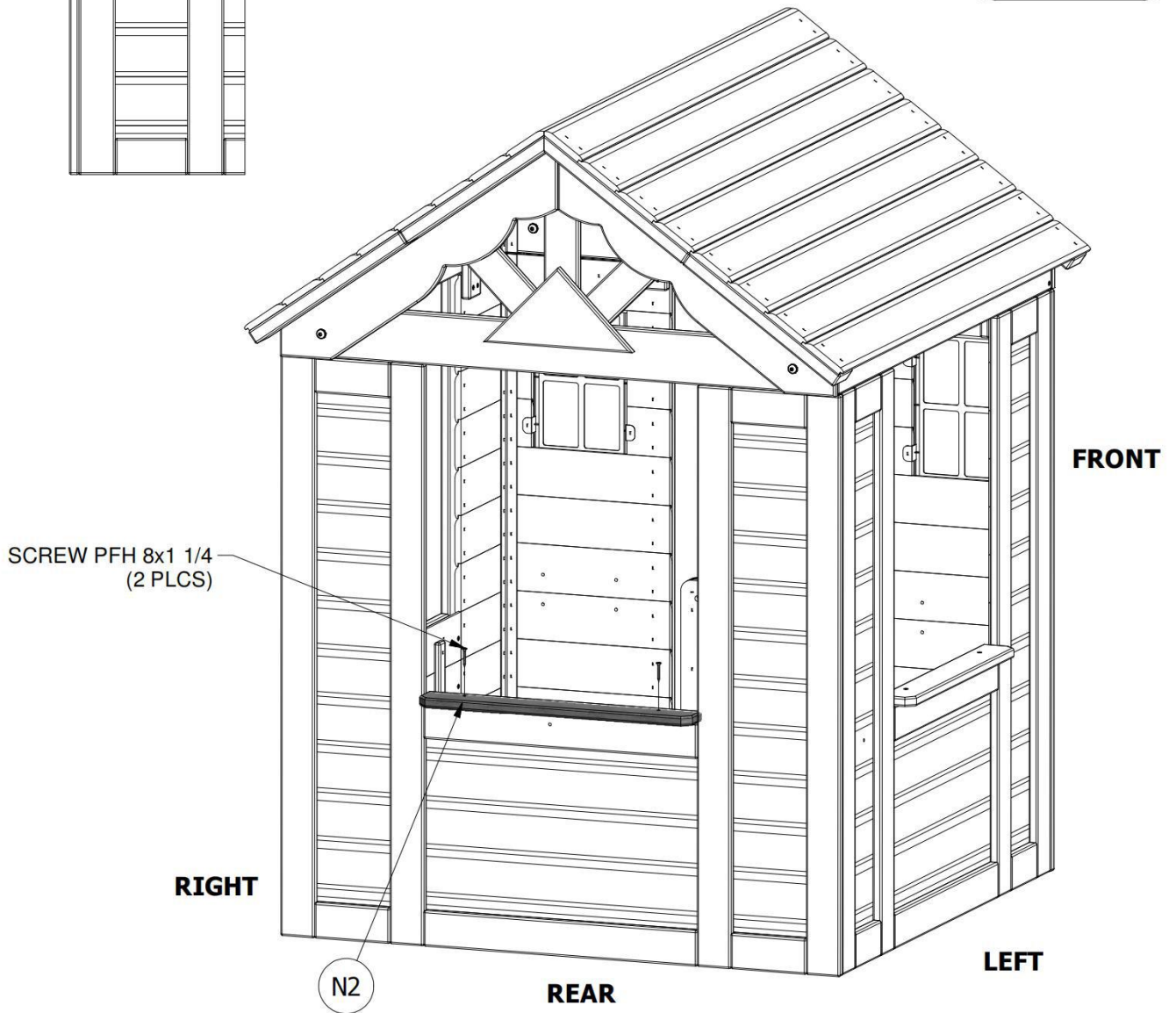
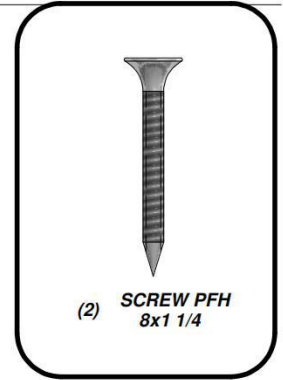
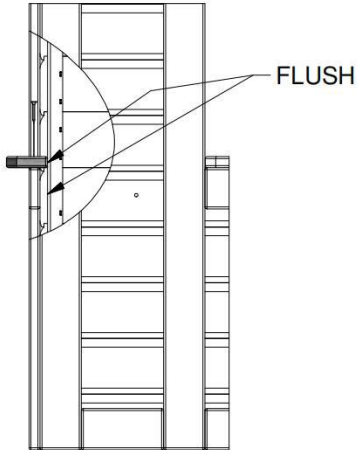



(1) **N1 - SIDE WINDOW SHELF - W4L04751**
5/8"x2 3/8"x18 7/8" (16x60x479)

STEP 15:

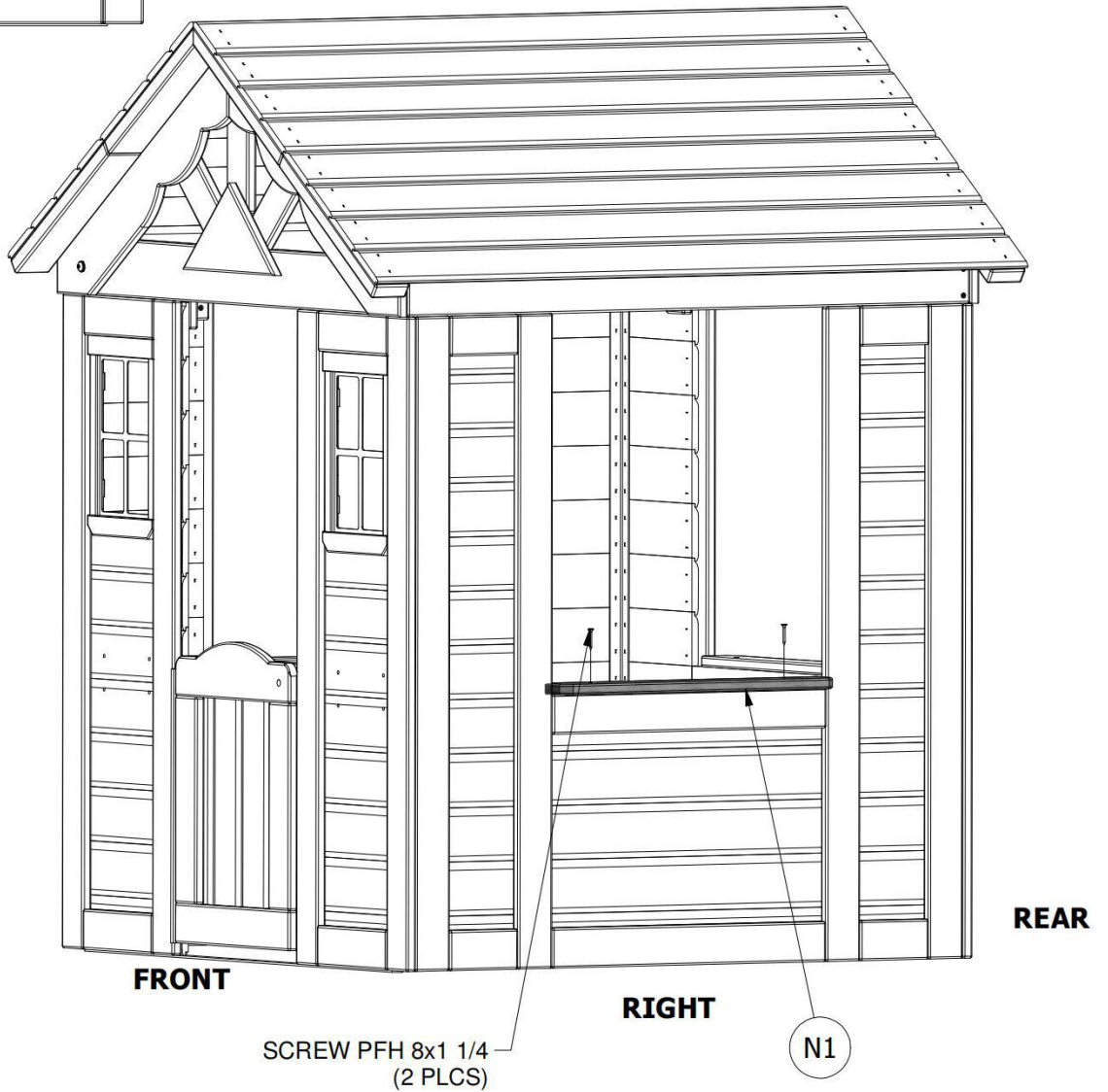
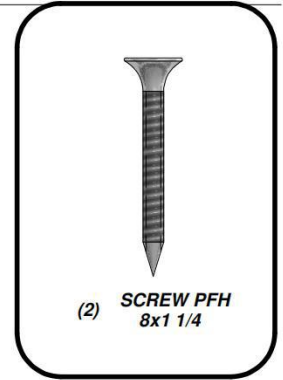
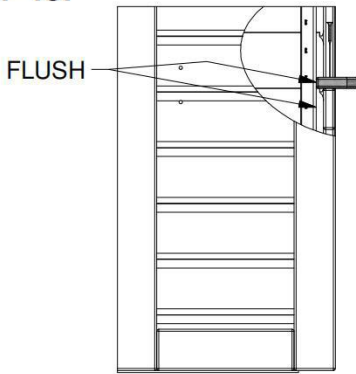

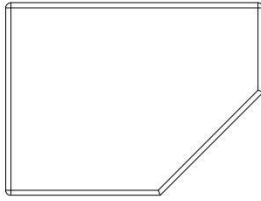

(1) **Q1 - COUNTER TOP SUPPORT - W4L04752**
1"x4 3/8"x5 7/8" (24x112x150)

STEP 16:

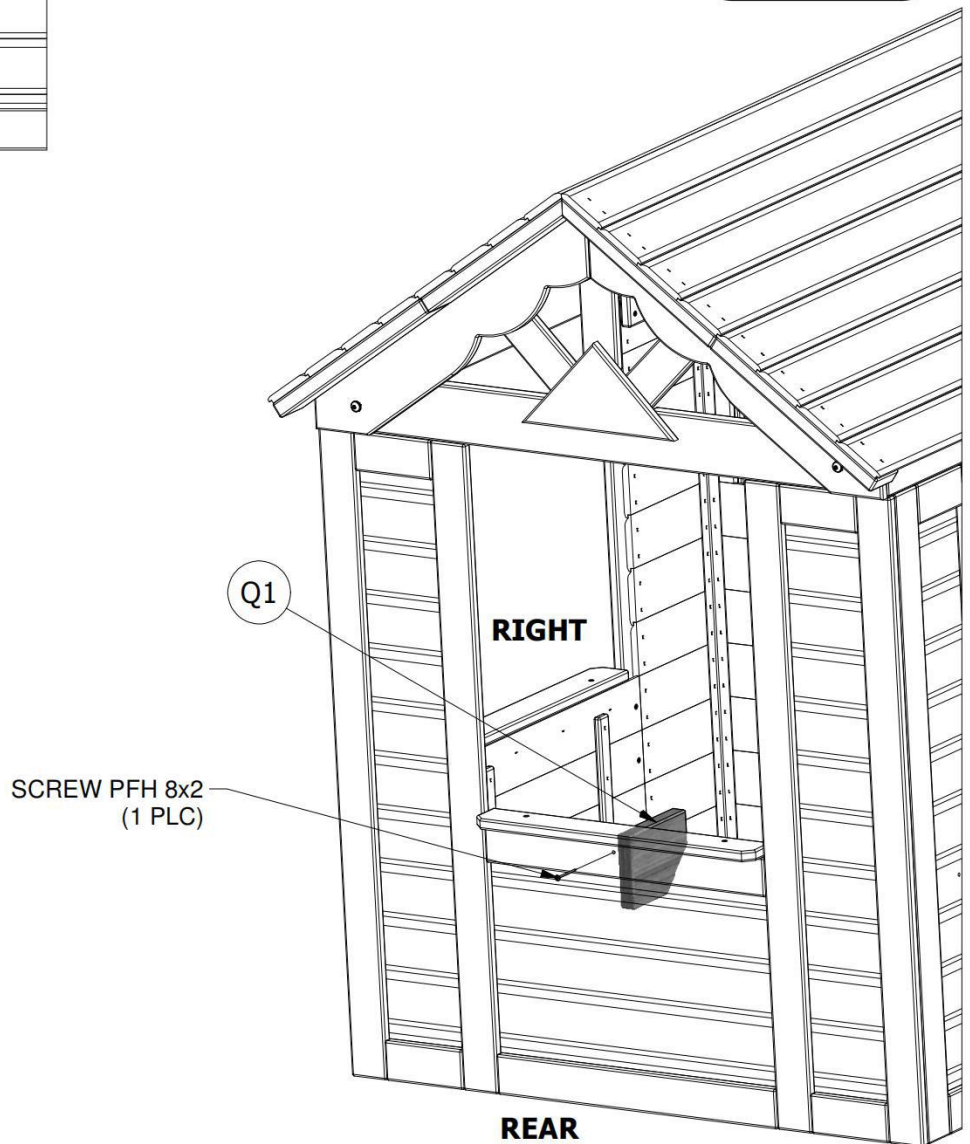
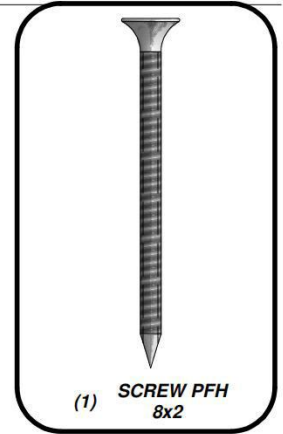
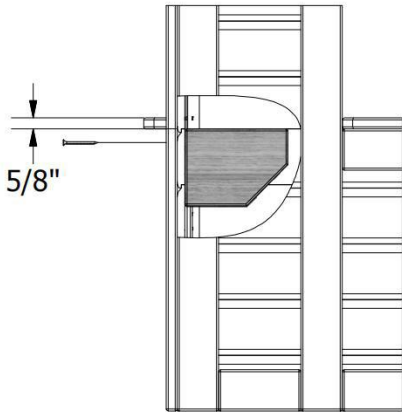

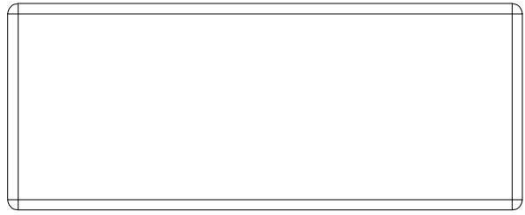

(2) **J1 - COUNTER TOP SUPPORT - W4L04753**
1"x2 3/8"x5 7/8" (24x60x150)

STEP 17:

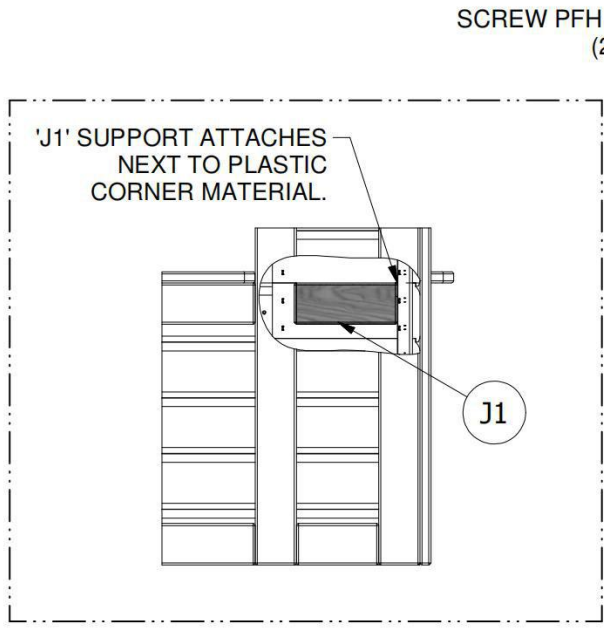
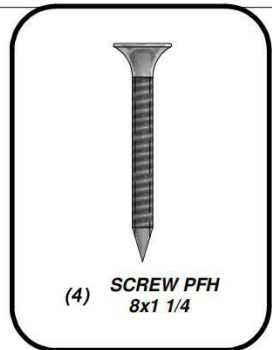
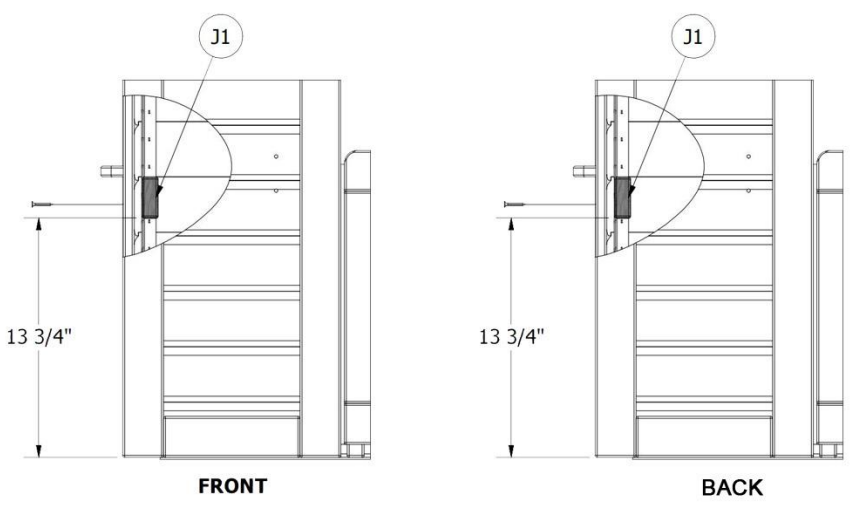

SCREW PFH 8x1 1/4
(2 PLCS)

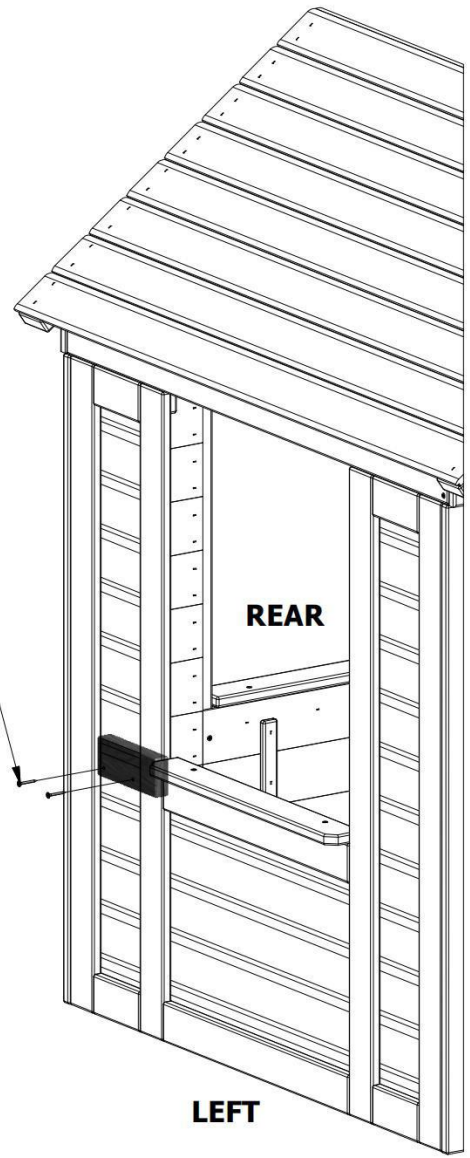

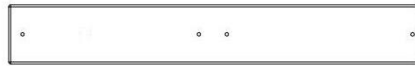

(2) **M1 - COUNTER TOP - W4L04754**
5/8"x3 3/8"x36 7/8" (16x86x938)

STEP 18:

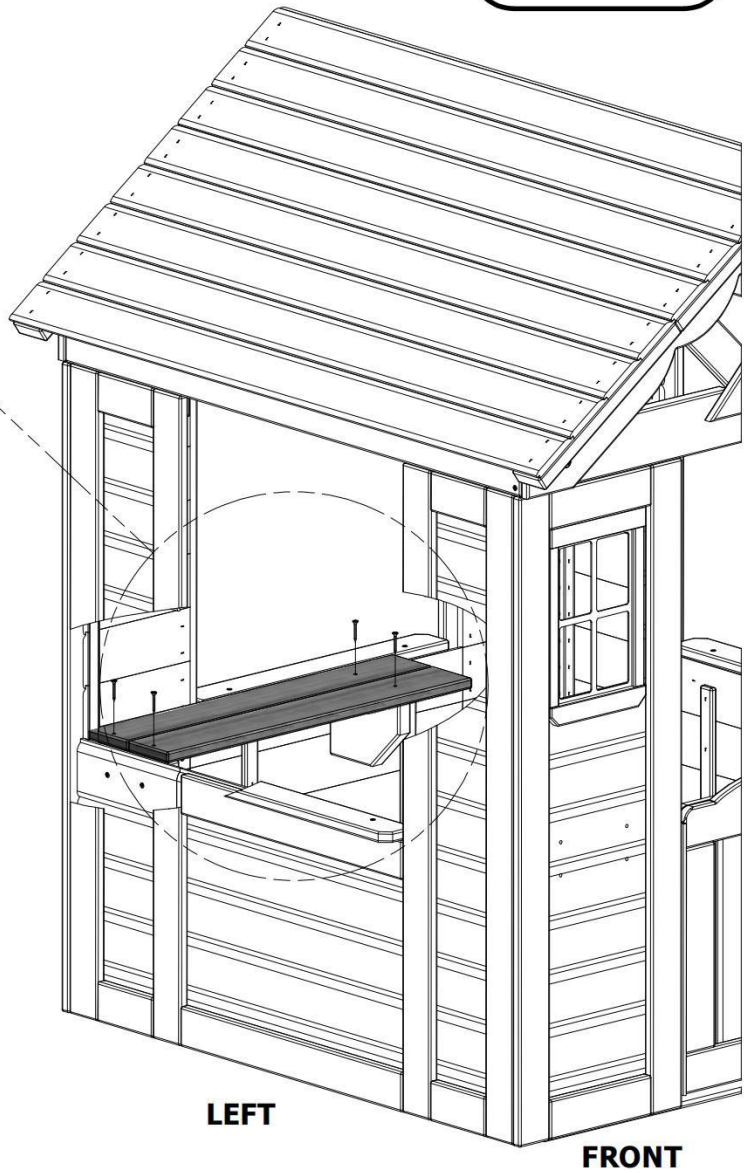
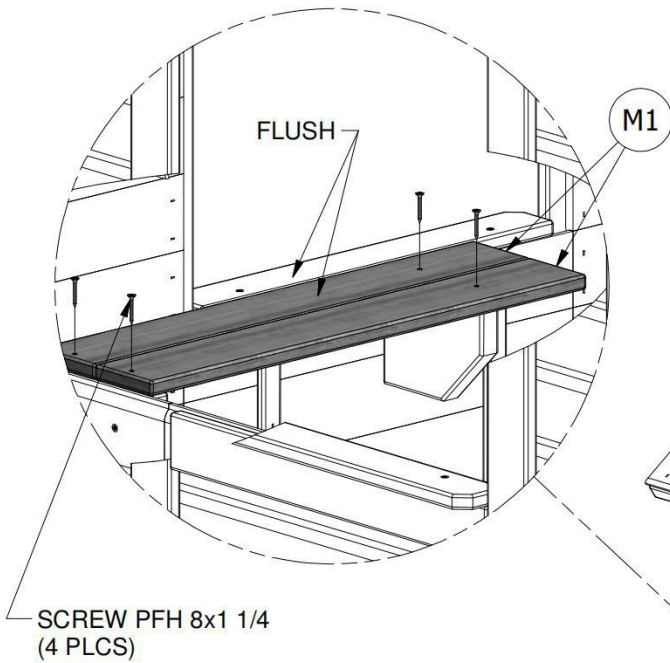
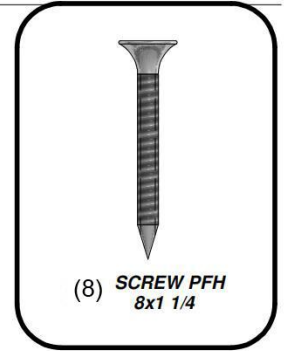



A6P00020 | HZ-KNOB
(x1)



H100086 | SCREW PFH
(x1) | 8x1

STEP 19:

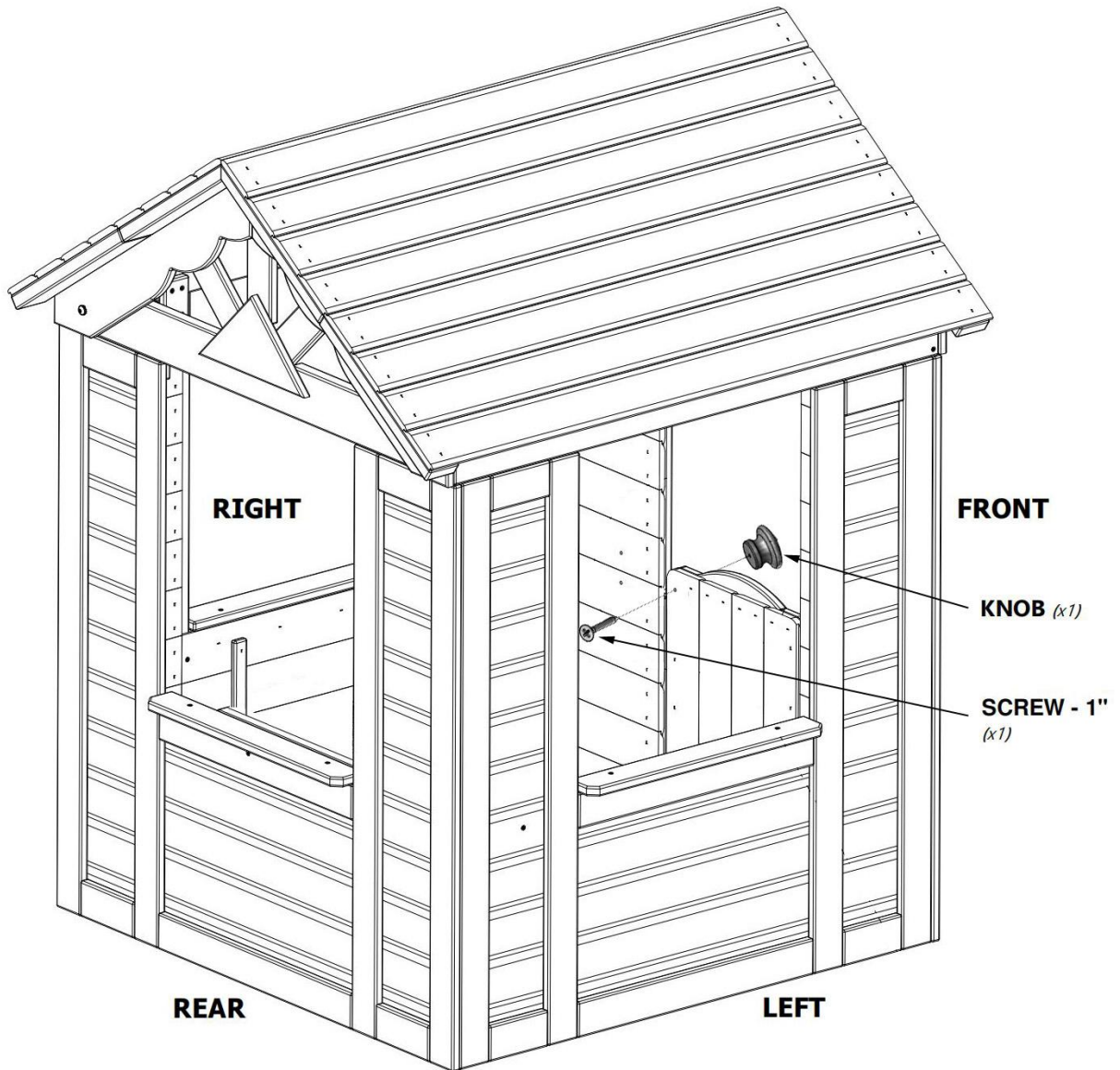

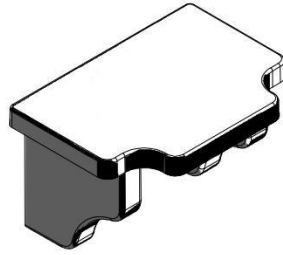

(2) FLOWER POT HOLDER - A6P00023

STEP 20:

