

ASSEMBLY INSTRUCTIONS

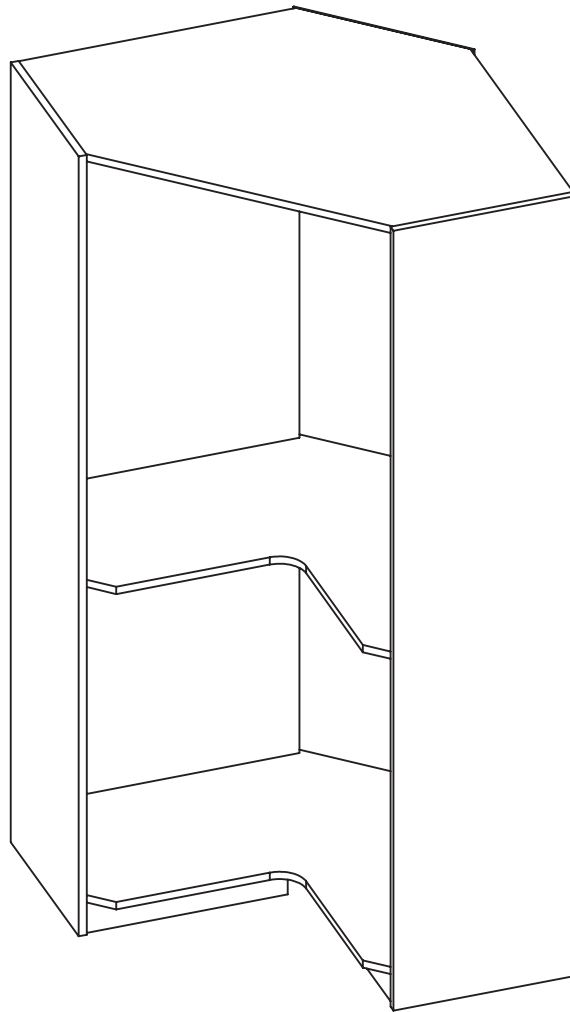

WF318934 / WF318935

Detail View

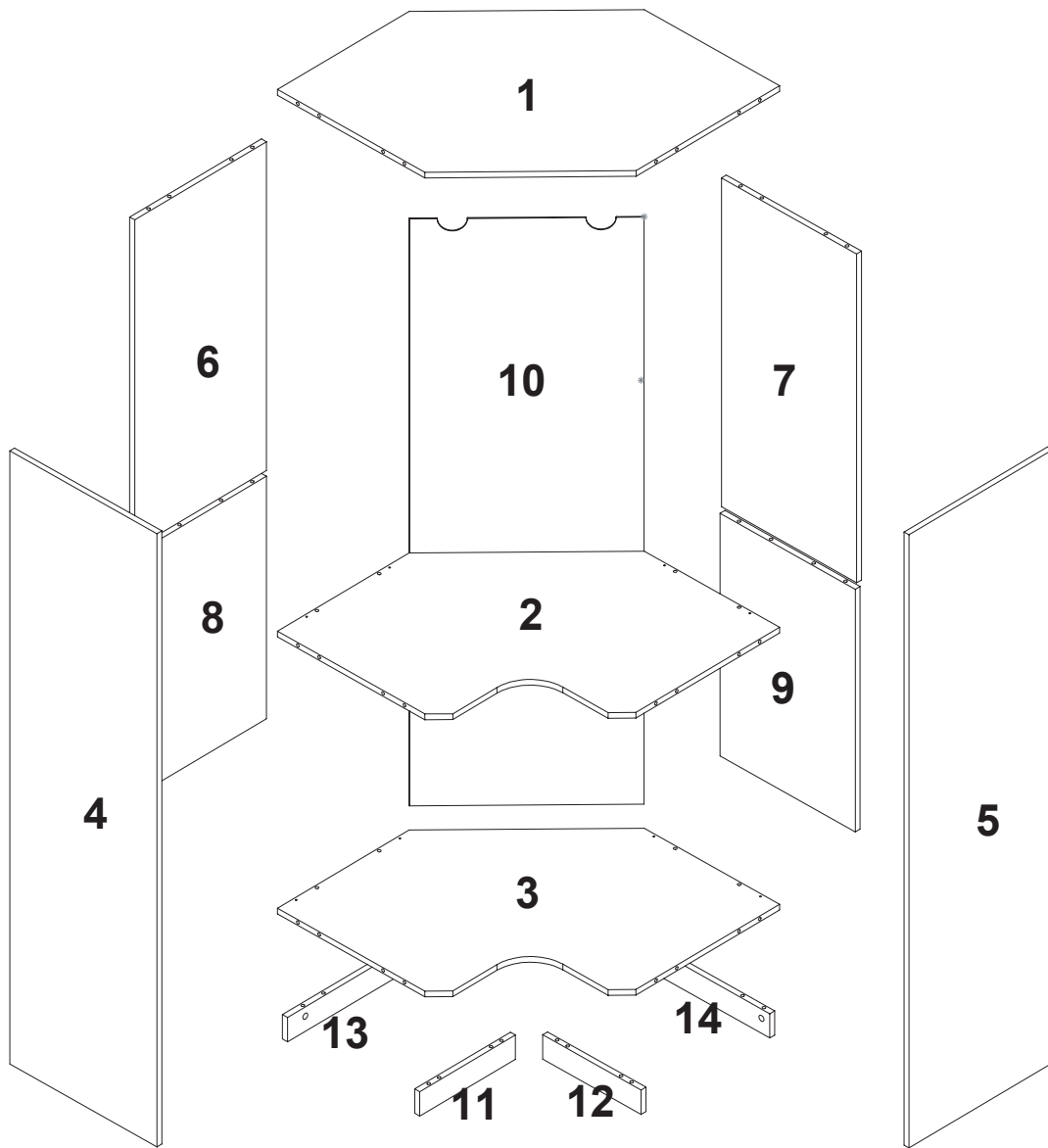

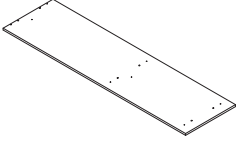
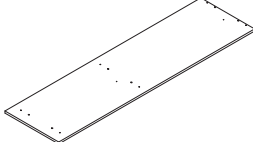
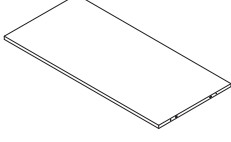
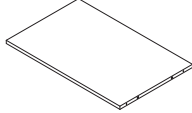
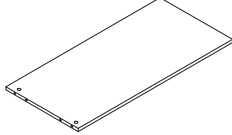
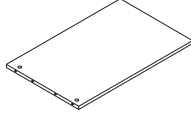
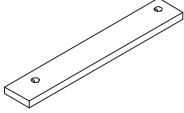
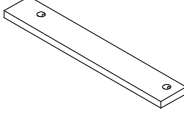
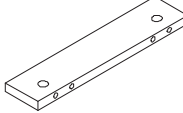
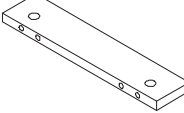
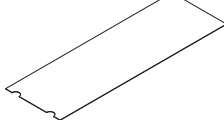

Part List

WF318934



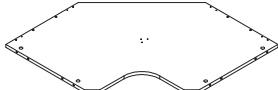



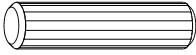

<p>4</p>  <p>Front Side Panel (Left)- 1pc</p>	<p>5</p>  <p>Front Side Panel (Right) - 1pc</p>	<p>6</p>  <p>Back Panel (Top Left) - 1 pcs</p>
<p>8</p>  <p>Back Panel (Bottom Left) - 1 pcs</p>	<p>7</p>  <p>Back Panel (Top Right) - 1 pcs</p>	<p>9</p>  <p>Back Panel (Bottom Right) - 1pc</p>
<p>13</p>  <p>Back Leg (Left) - 1pcs</p>	<p>14</p>  <p>Back Leg (Right) - 1pcs</p>	<p>11</p>  <p>Front Leg (Left) - 1pcs</p>
<p>12</p>  <p>Front Leg (Right) - 1pcs</p>	<p>10</p>  <p>Back Panel (Center) - 1pcs</p>	

WF318935

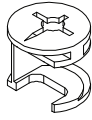
<p>1</p>  <p>Top Panel- 1pc</p>	<p>2</p>  <p>Middle Panel - 1pc</p>	<p>3</p>  <p>Bottom Panel - 1pc</p>
---	---	---

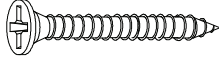
Hardware List

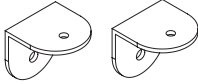
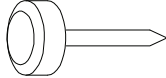
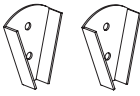
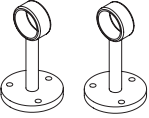
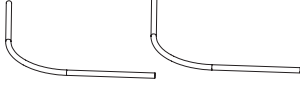
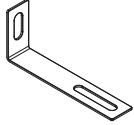
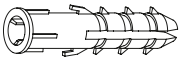
WF318935



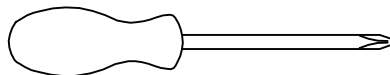

A  Ø8X30mm Wood dowel (36pcs)	C  Cam Bolt (28pcs)	D  Cam Nut (28pcs)
E  Ø3.5X16mm Chip Board Screw (32pcs)	F  Ø4X45mm Chip Board Screw (10pcs)	G  Nails (34pcs)
H  L-Bracket 404 (8 pcs)	I  5/8" Glider with Nails (12 pcs)	J  V Top Chrome (4pcs)
K  Centre Chrome Pipe holder (2pcs)	L  Hanger Rail (2pcs)	M  Metal Mounting L-Bracket (2pcs)
N  Wall Plug (2pcs)	O  Washer M4 (2pcs)	

ASSEMBLY TOOLS REQUIRED (NOT INCLUDED)

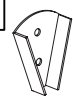

PLEASE BE CAREFUL DO NOT DAMAGE THE HOLE POSITION WHEN YOU USE POWER TOOLS !

STEP 1:

E		C		J		I	
8 PCS		12 PCS		4 PCS		4 PCS	

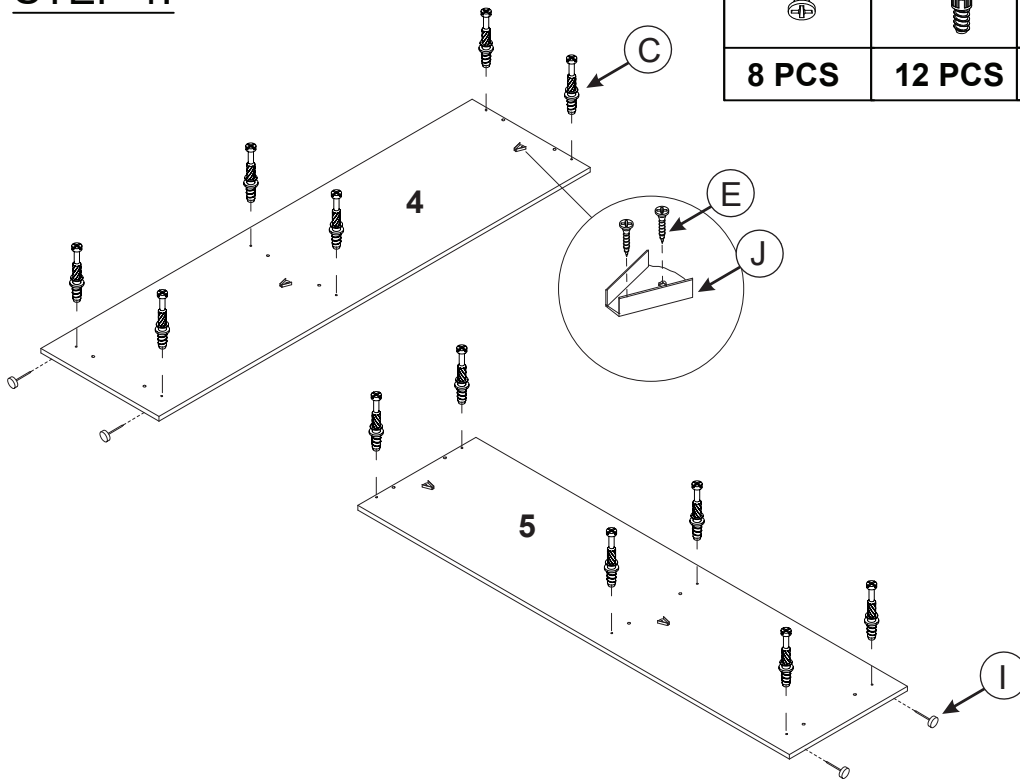

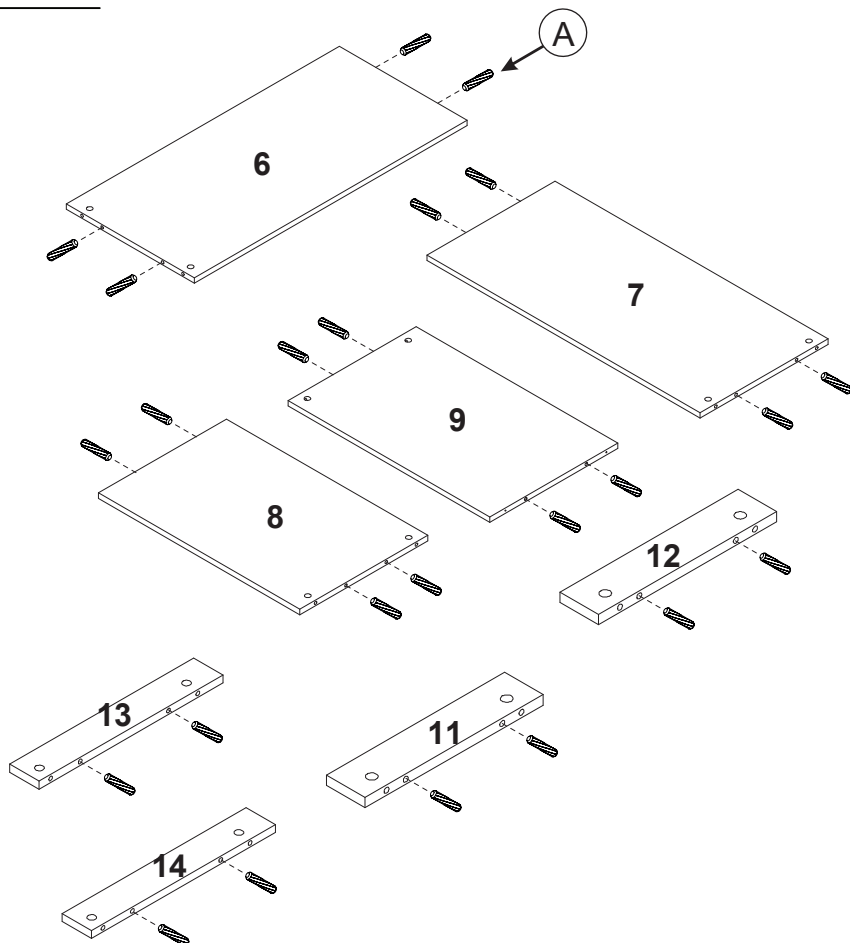

STEP 2:

A	
24 PCS	



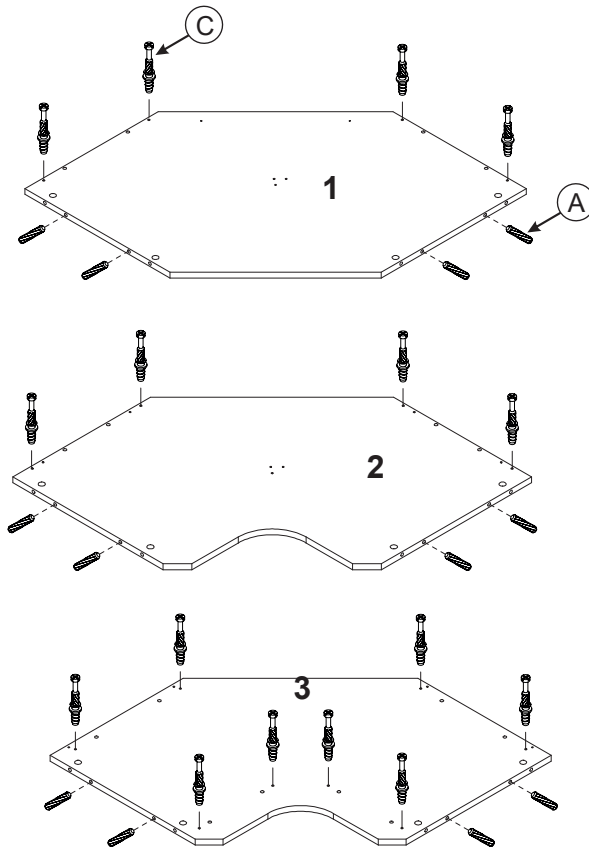

STEP 3:

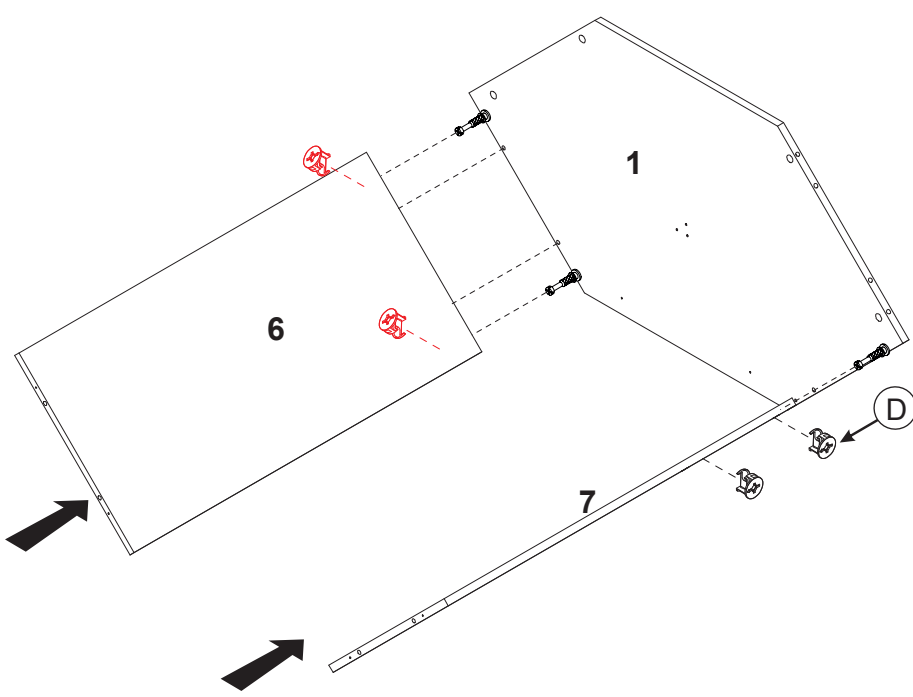

A		C	
12 PCS		16 PCS	

STEP 4:



D	
4 PCS	

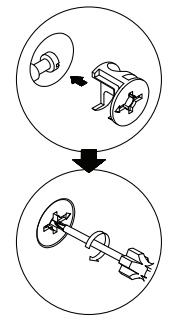

STEP 5:

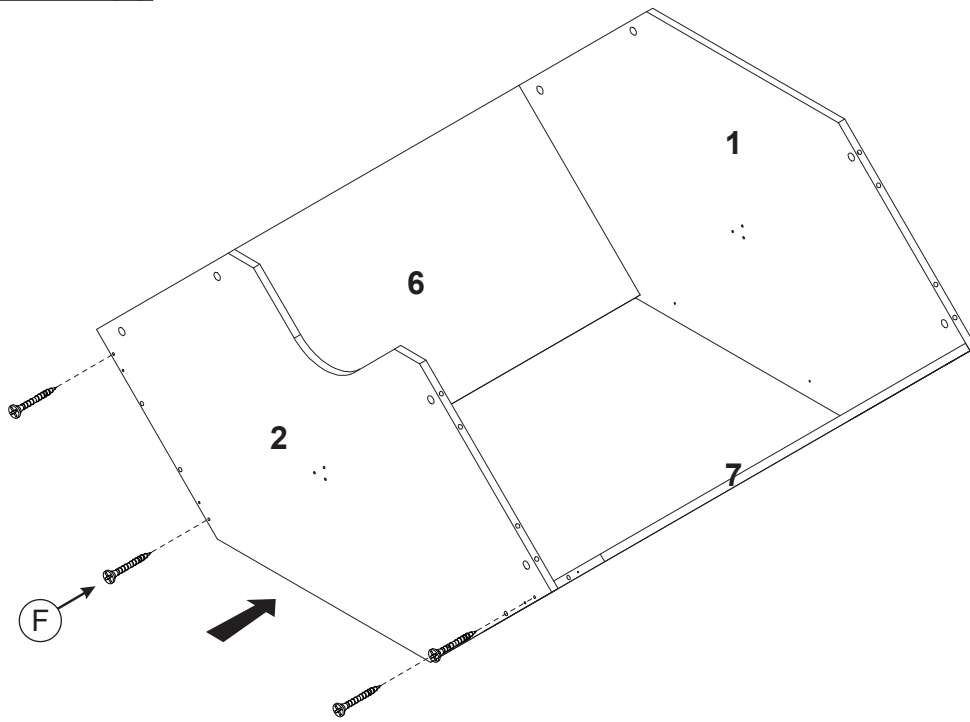

F

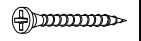

4 PCS

STEP 6:

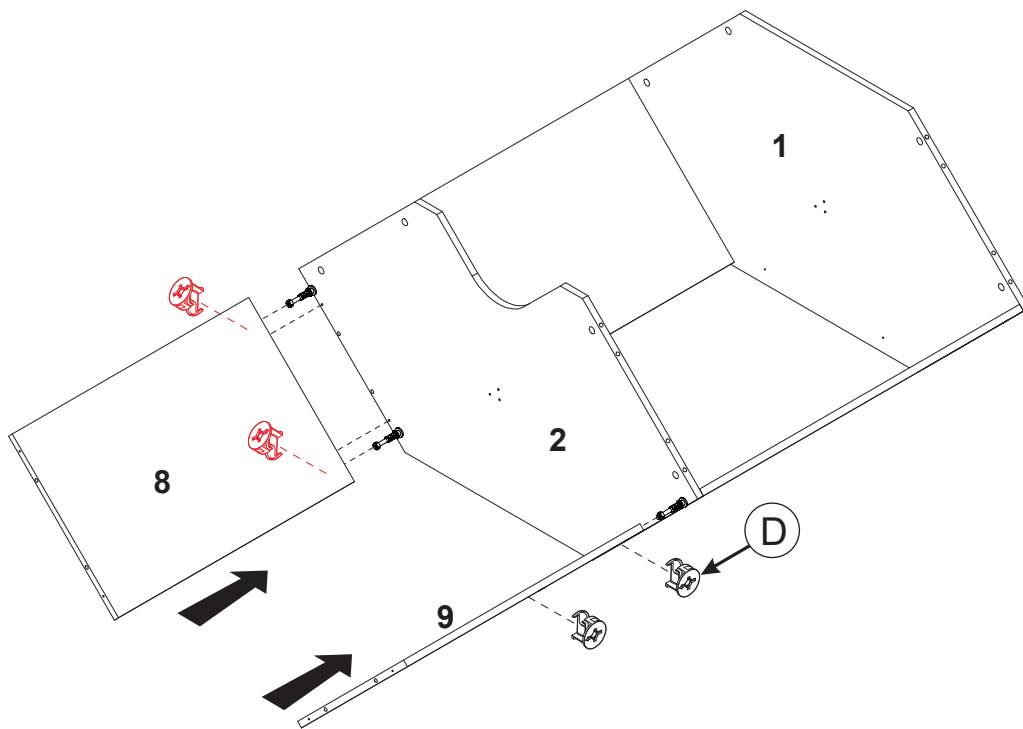

D



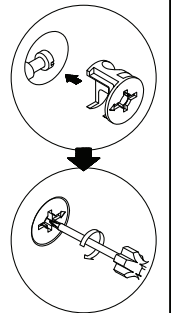

4 PCS

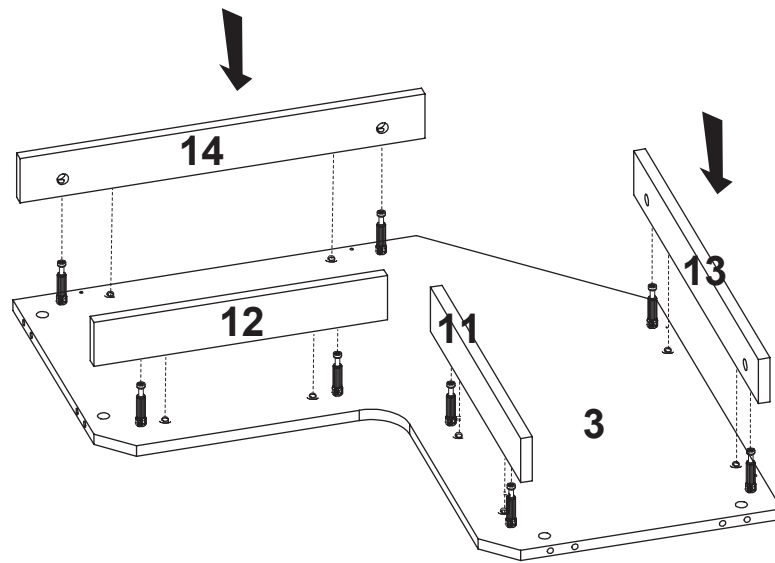

STEP 7:



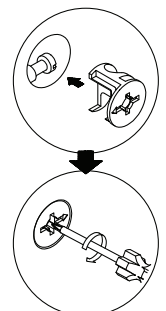
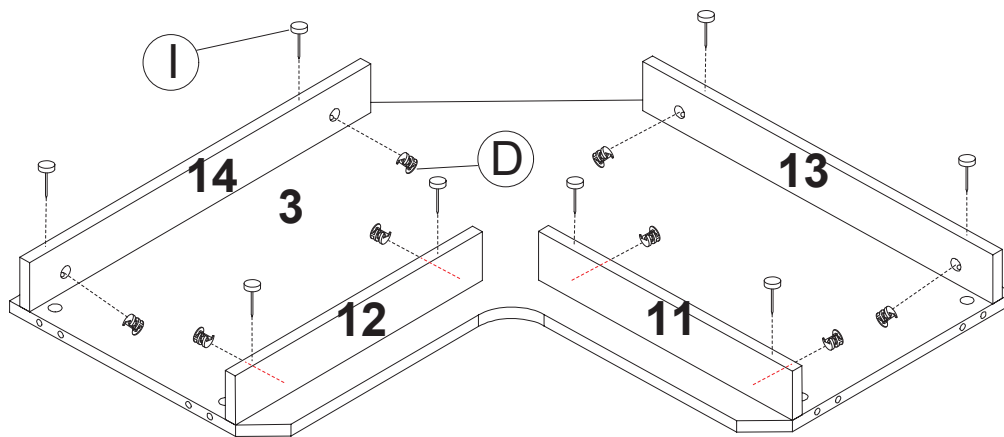

STEP 8:

I		D	
8 PCS		8 PCS	



STEP 9:

E		H	
16 PCS		8 PCS	

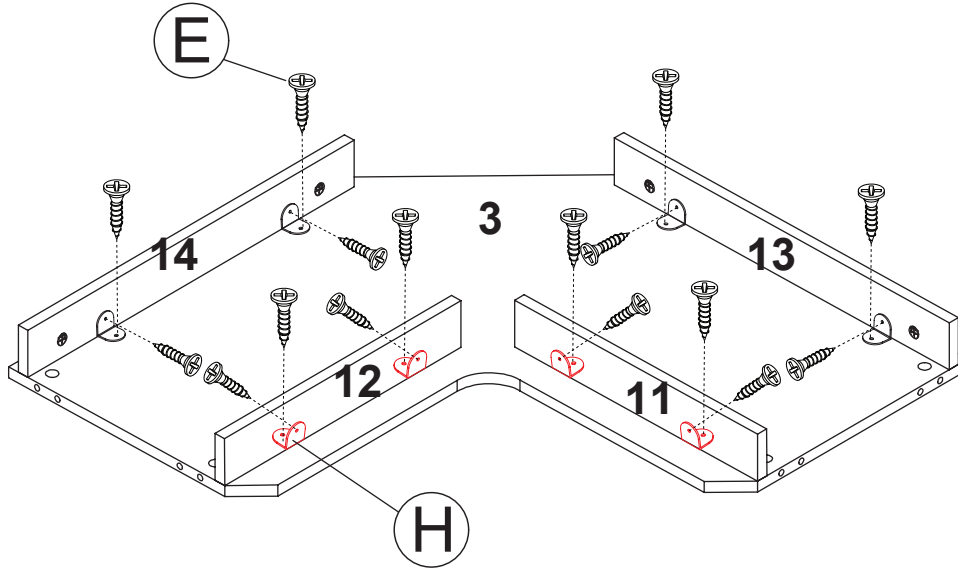

STEP 10:

F	
4 PCS	

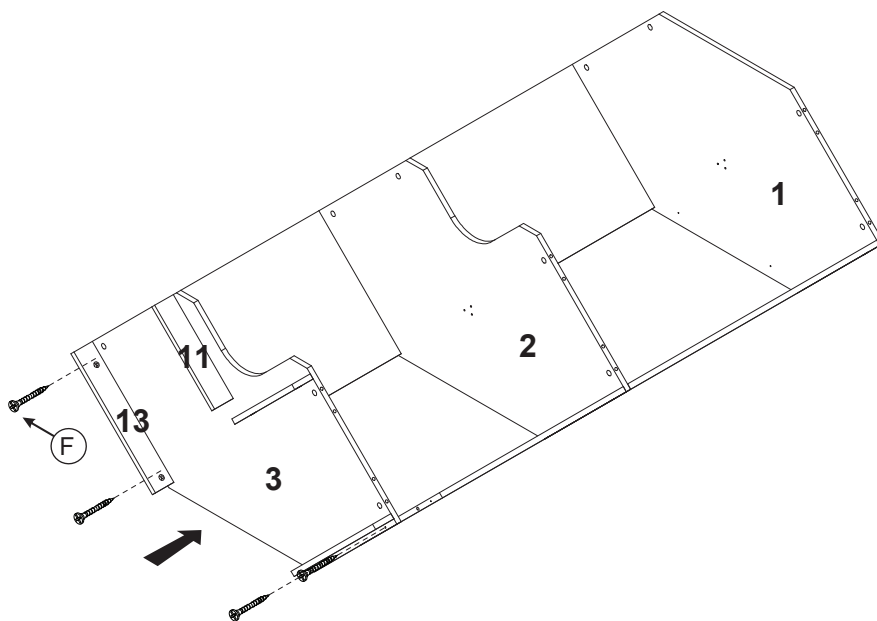

STEP 11:

D

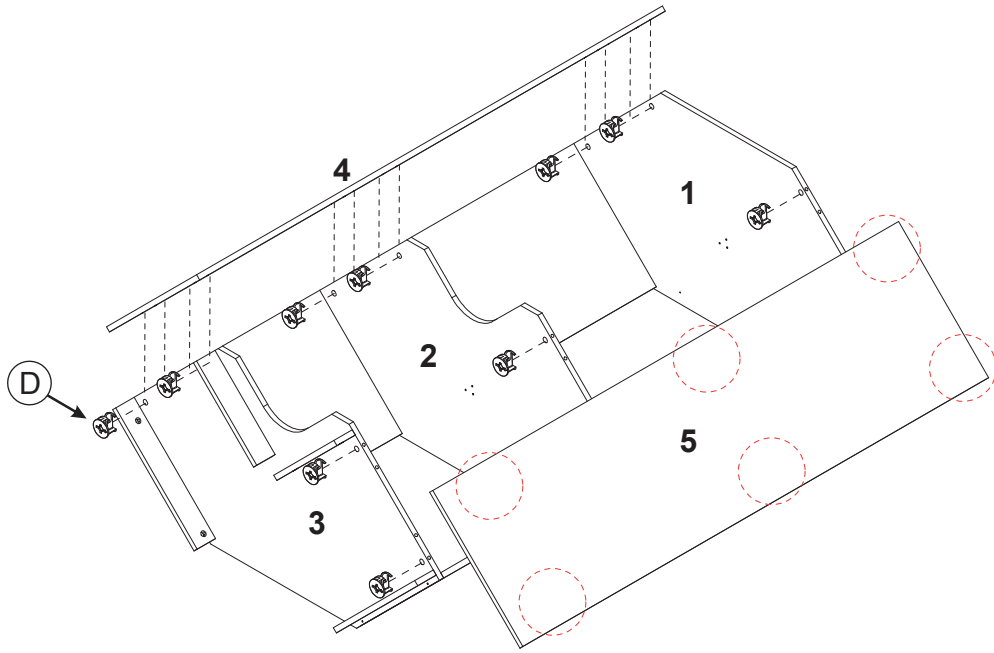
4 PCS



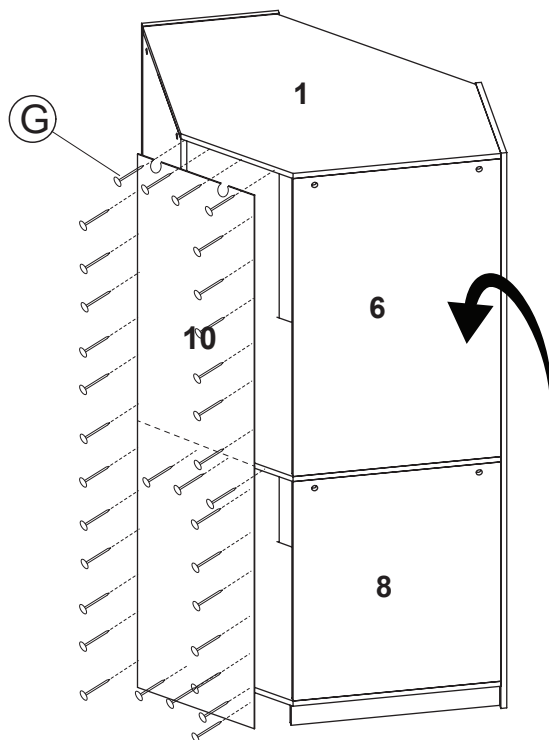

STEP 12:

G

34 PCS

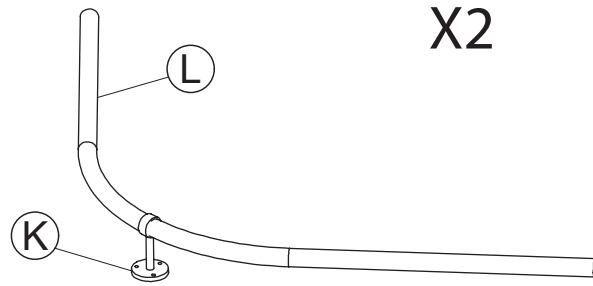



STEP 13:

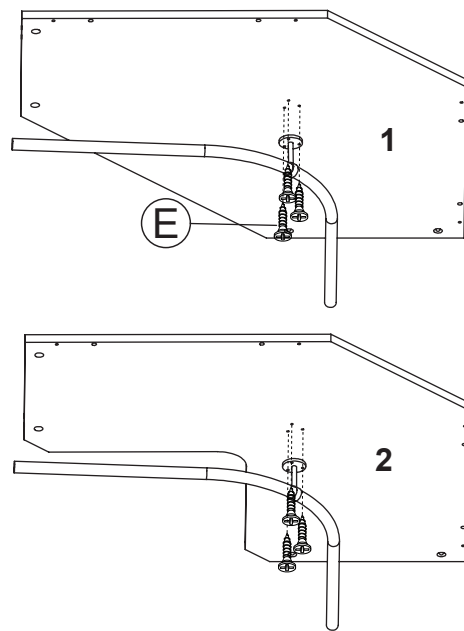

L	K
	
2 PCS	2 PCS

STEP 14:



E

6 PCS

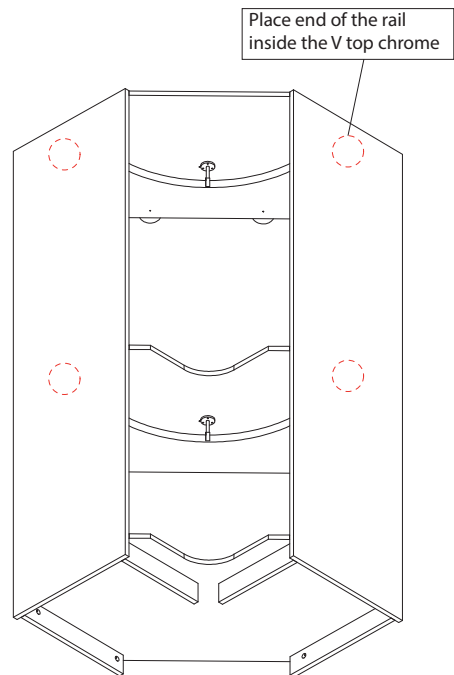
STEP 15:





FURNITURE ANTI-TIPPING INSTALLATION



This anti-tipping must be attached to a wall stud using screw enclosed:

1. After assembling the unit place it against the wall where it will be permanently positioned.
2. Place the bracket inside of the wardrobe as shown in the diagram.
3. Use a pencil to mark through the screw hole in the bracket, where the bracket has to be attached to the wall.
4. Move the cabinet away from the wall and secure the bracket to the wall at the marked position using a wall anchor suited to your wall surface.
5. With the wall brackets in position, move the cabinet back to the wall.
6. Then using the screw supplied, secure the horizontal arm of the brackets to the top of the wardrobe.

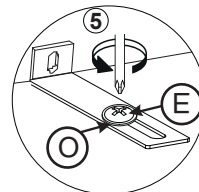
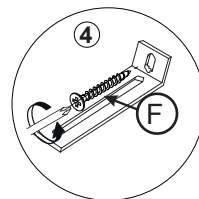
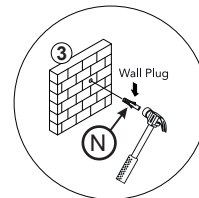
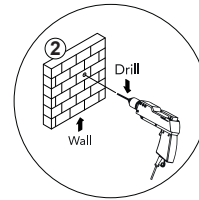
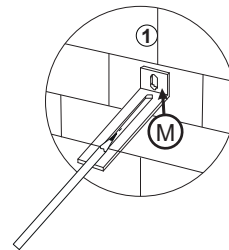
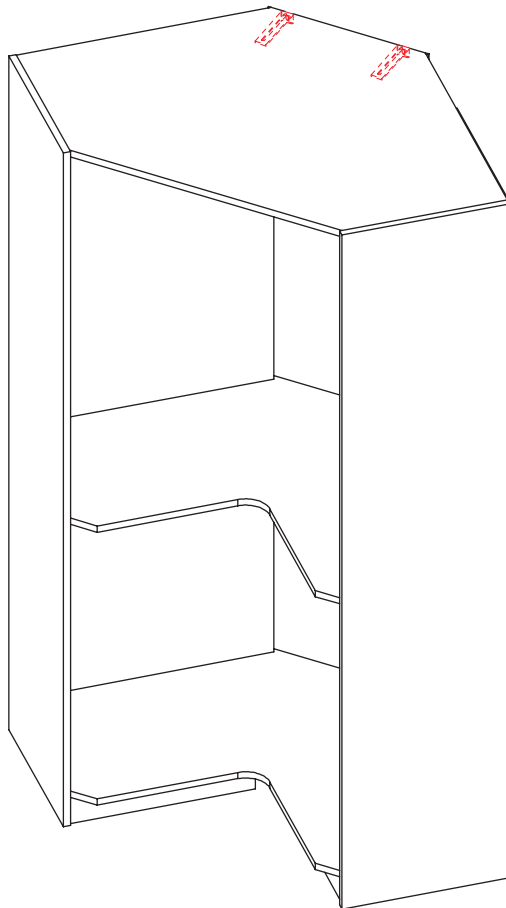

TIGHTEN THE SCREWS

Manufacturer: Kim Hoo Ventures Sdn Bhd
 Address: 6223 & 6223, Jalan Bagan Lalang,
 Taman Industries Cengal, 13400 Butterworth,
 Penang.
 Manufacturing Date: July 2023

E		M		N		O		F	
2PCS		2PCS		2PCS		2PCS		2PCS	

Meets ASTM F3096-14