

BRON 24in Bathroom Vanity Installation Manual

ASSEMBLY INSTRUCTIONS

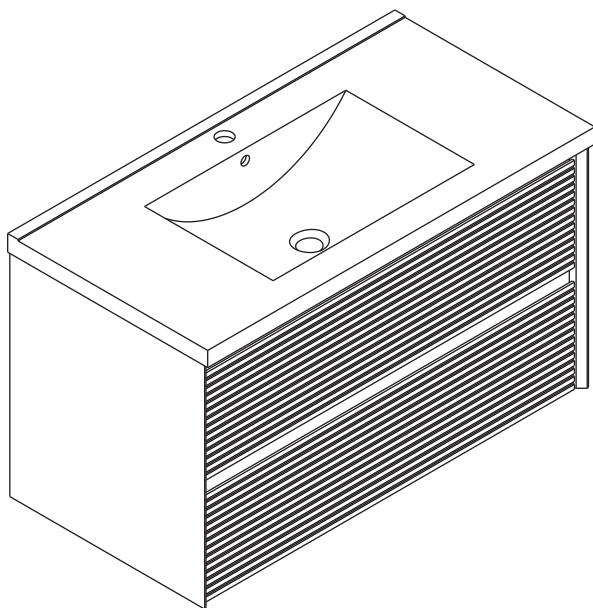

Bathroom Vanity

ASSEMBLY INSTRUCTIONS

Notice:

1. Follow the installation instructions. Please confirm all accessories are preset before installation.
2. Do not fully tighten the screws during initial assembly. Fully tighten screws only once all pieces which are correctly assembled.
3. If you encounter any problems during installation, please contact our customer service.
4. Please unbox the item from the side with an open-label and put a carpet on the floor to avoid scratching it.



Recommended installers : 2

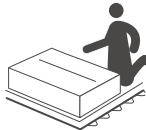

Put a carpet on the floor before unpacking



Estimate installation time:
30 minutes

Item no.	Reference Image	Qty	Item no.	Reference Image	Qty
A		x1	3		x4
B		x1	4		x6
1		x4	5		x1
2		x4			

ASSEMBLY INSTRUCTIONS

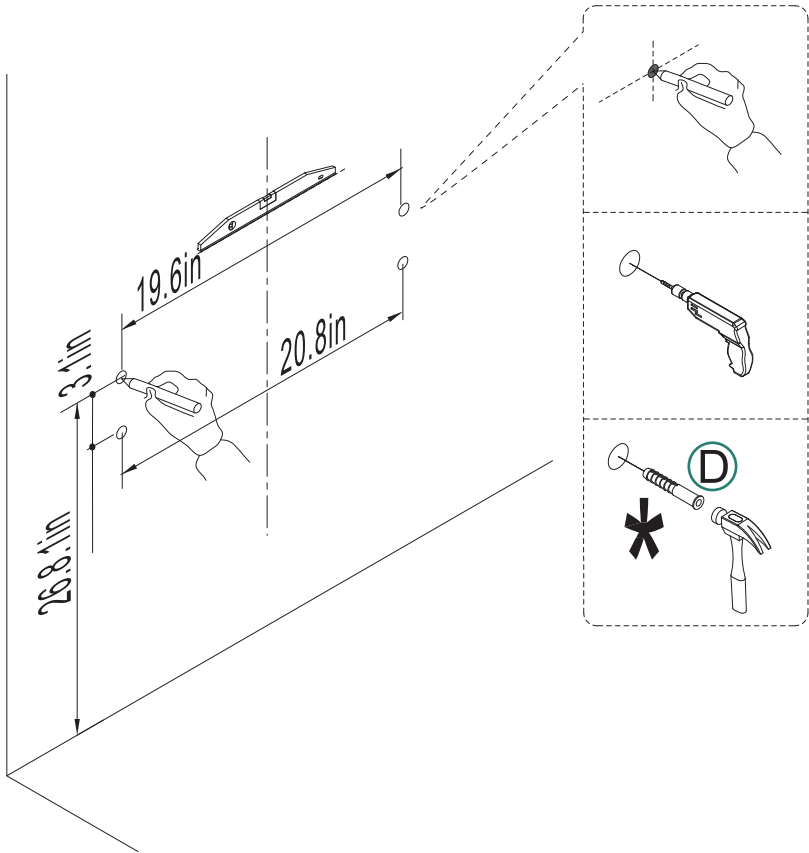
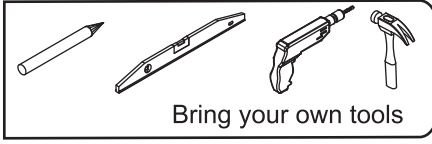
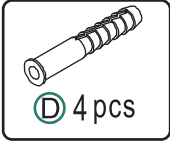

1



ASSEMBLY INSTRUCTIONS

2

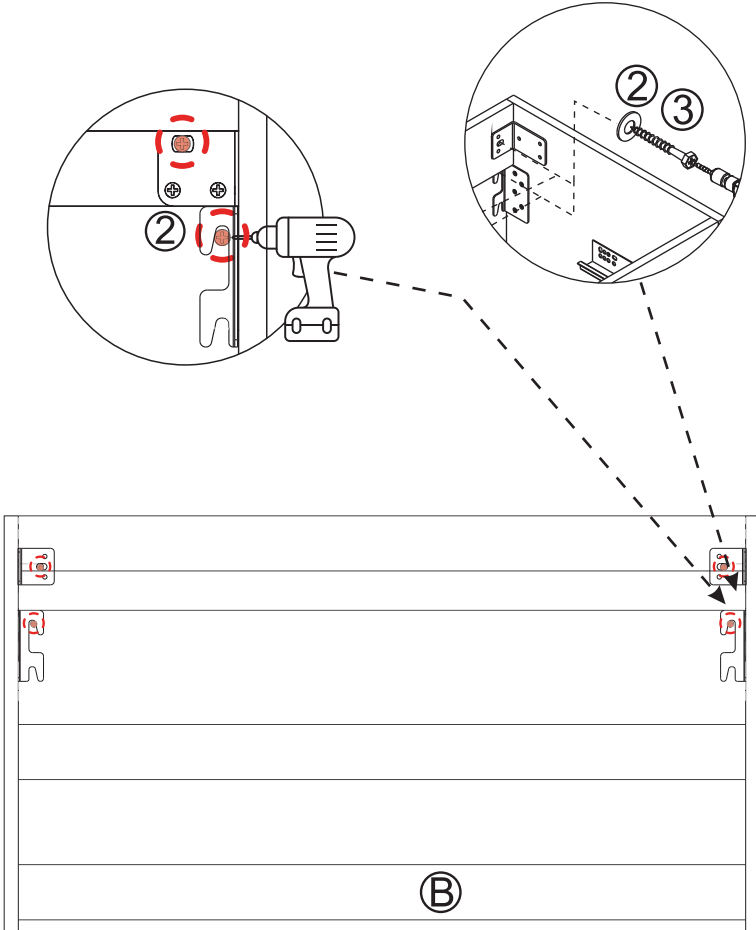
Ⓑ 1pc ② 4pcs ③ 4pcs



ASSEMBLY INSTRUCTIONS

3

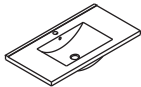

Ⓐ 1pc

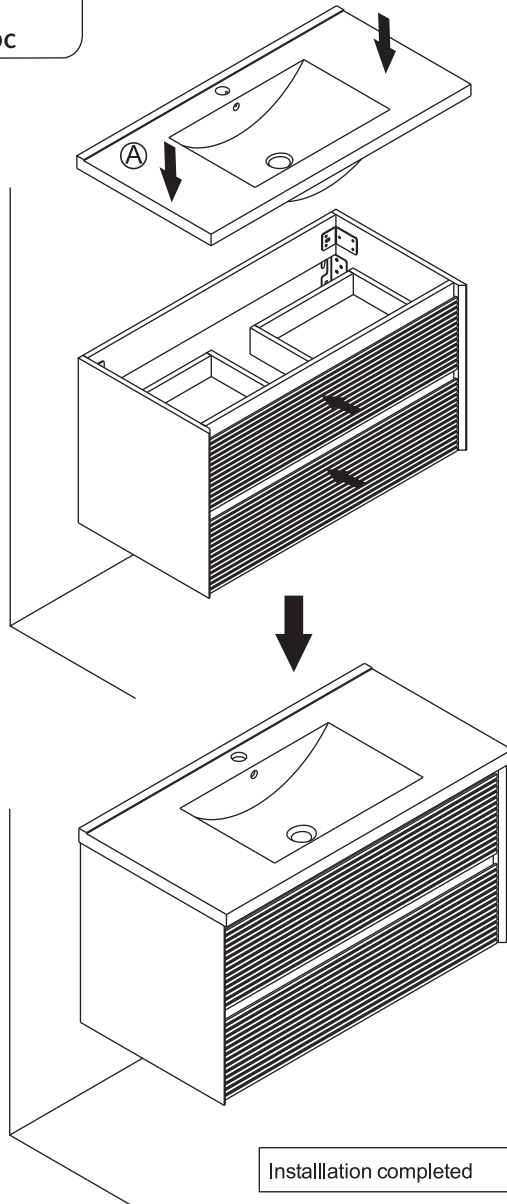

ASSEMBLY INSTRUCTIONS

4

Installation of drain assembly

Turn the screw at the bottom of the guide rail counterclockwise!

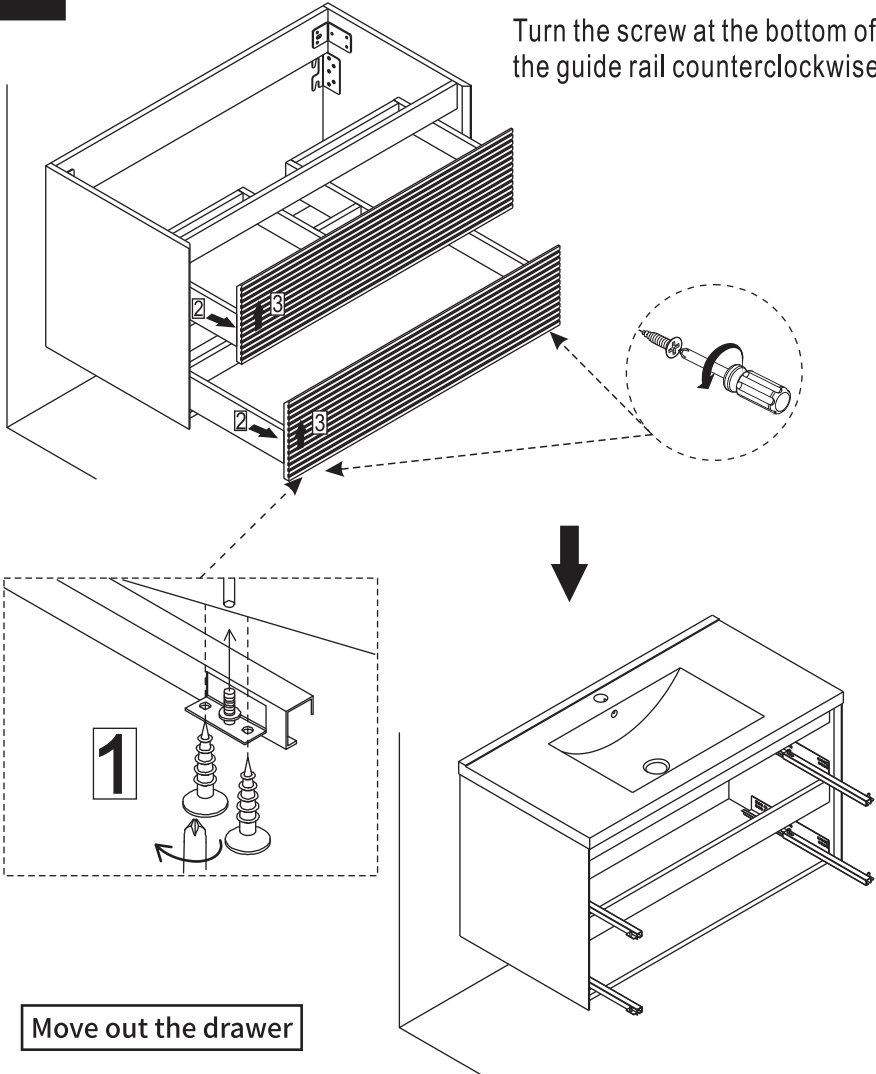

ASSEMBLY INSTRUCTIONS

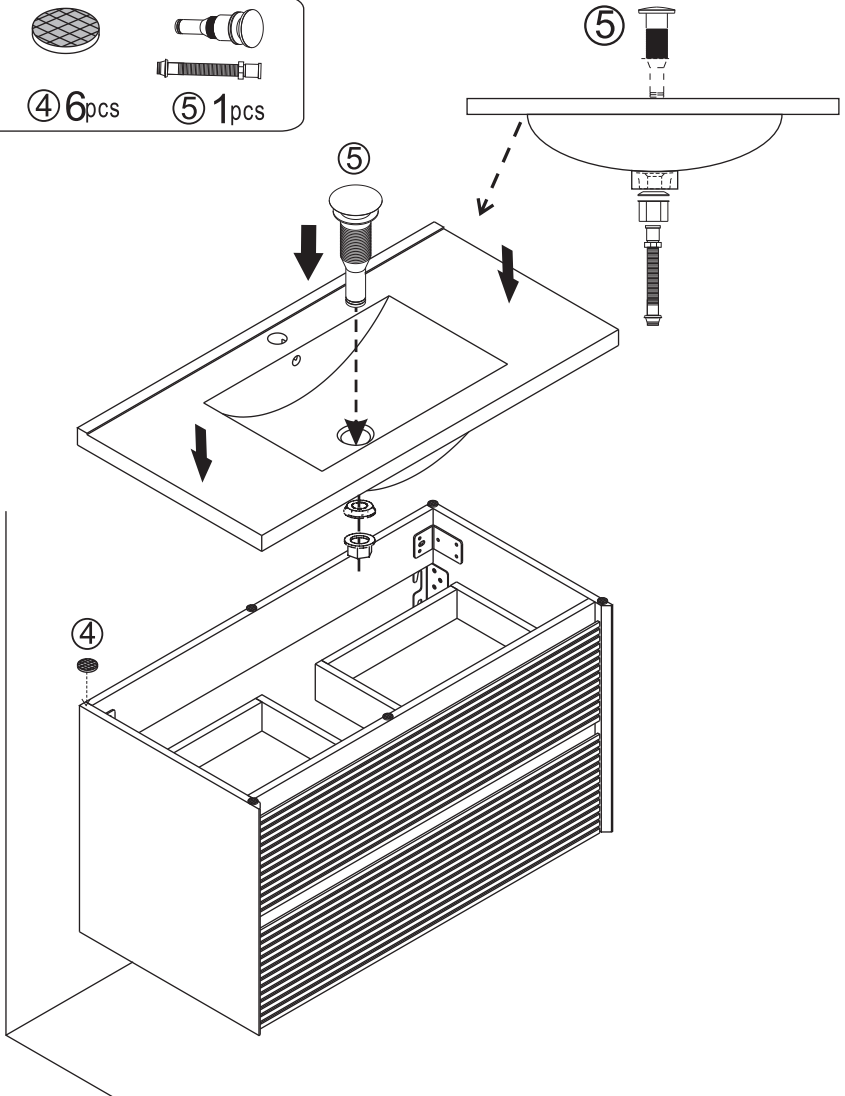
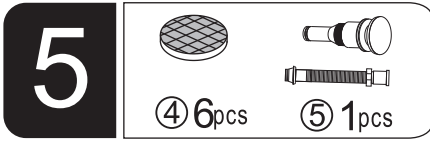

Installation of drain assembly

ASSEMBLY INSTRUCTIONS

6

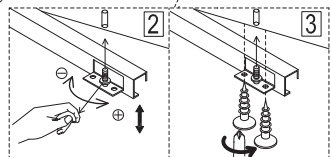
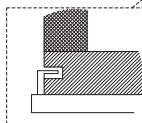
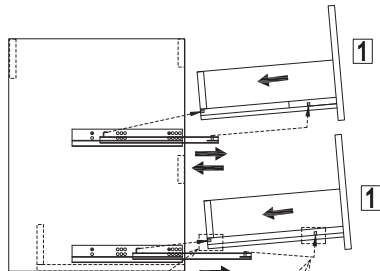
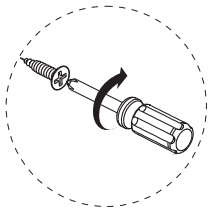
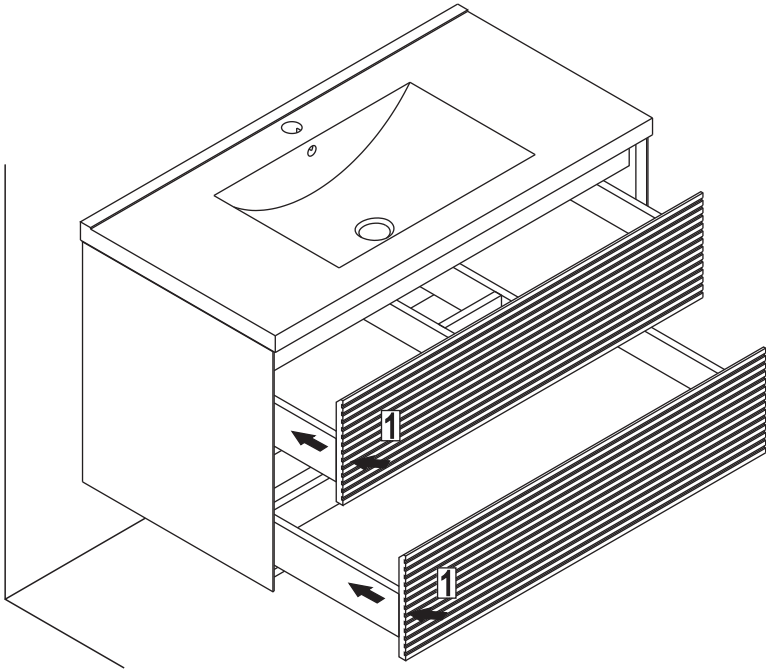

Installation completed