

INSTRUCTION MANUAL

Model: Y1214-4

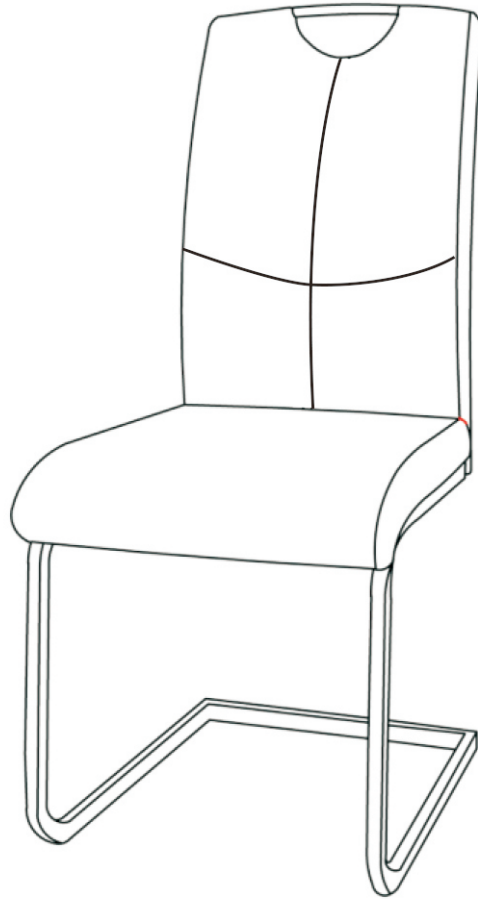

Attention :

If you encounter any problems during installation or use, pls feel free to contact us on shopping platform. We will provide you with a satisfactory solution within 24 hours.

Dining chair



1 - ITEMS DELIVERED-TECHNICAL DATA



2 - ASSEMBLY



3 - CLEANING AND MAINTENANCE



1 - ITEMS DELIVERED-TECHNICAL DATA

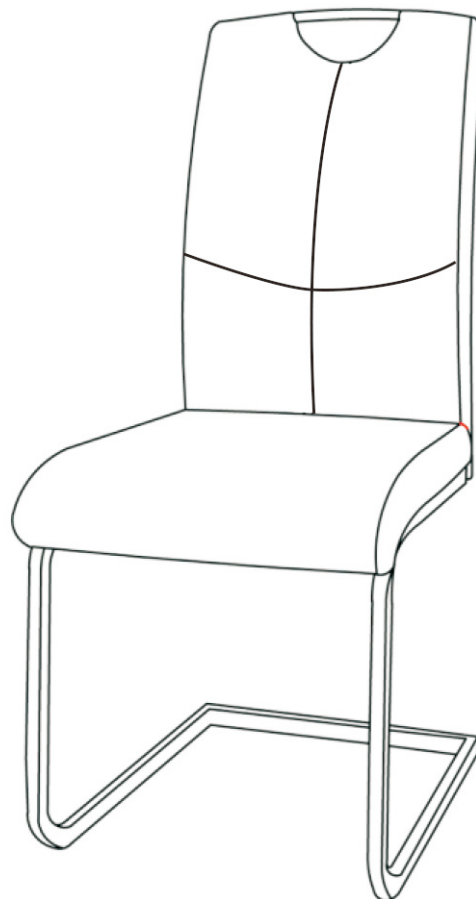

TO RISE

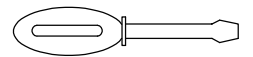

YOURSELF

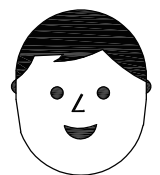

ASSEMBLY

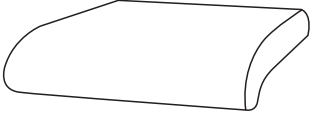
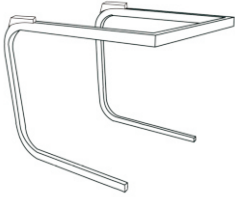
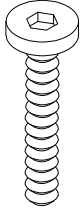
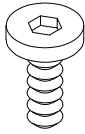
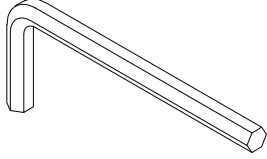
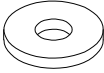
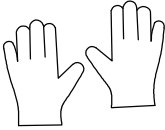

2 - ASSEMBLY

<p>(A)*1</p> 	<p>(B)*1</p> 
<p>(C)*1</p> 	<p>(D)*4</p>  <p>M6x20mm</p>
<p>(E)*4</p>  <p>M6x13mm</p>	<p>(F)*1</p>  <p>5x31x81mm</p>
<p>(G)*4</p>  <p>6x18x1.5mm</p>	<p>(H)*1</p> 

(D)*4 M6x20mm

(E)*4 M6x13mm

(F)*1 5x31x81mm

(G)*4 6x18x1.5mm

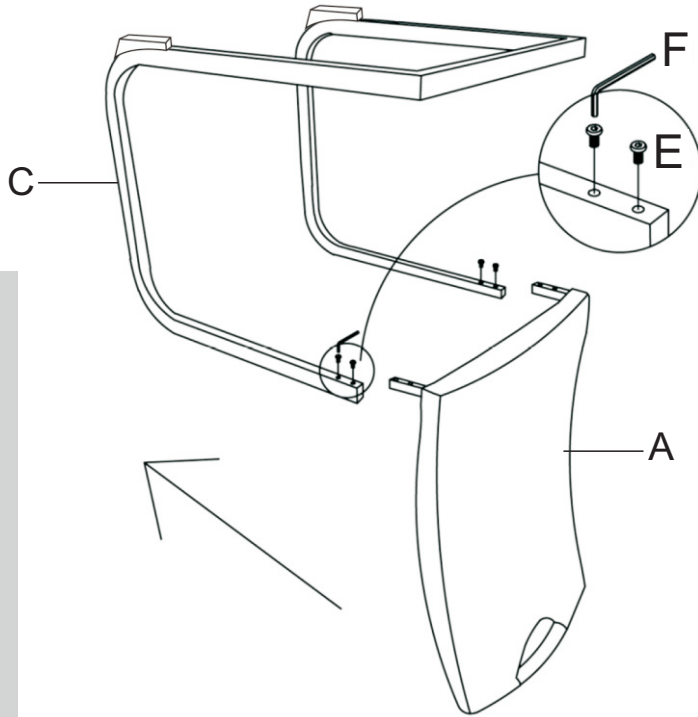

1

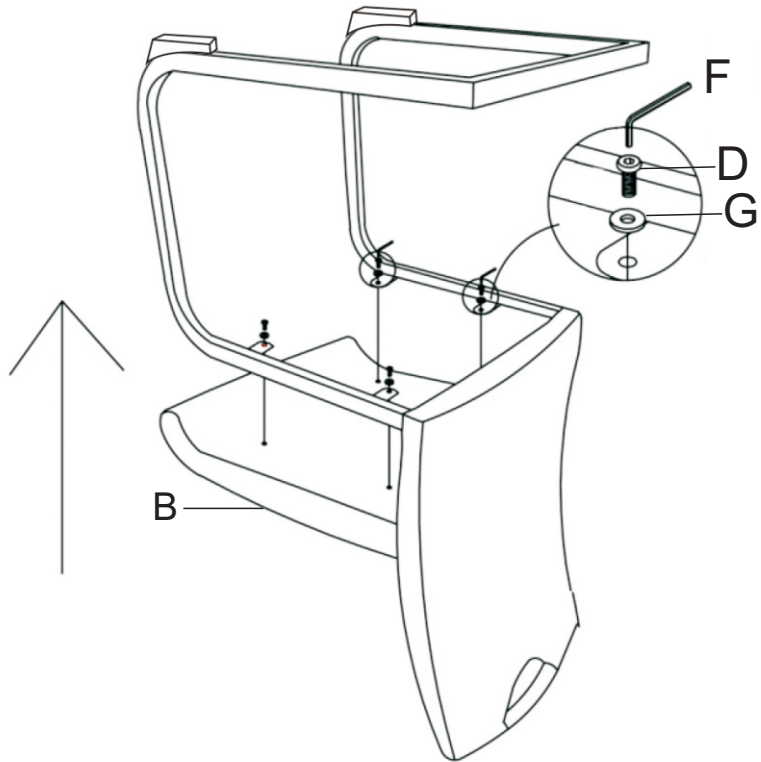

2

3

3

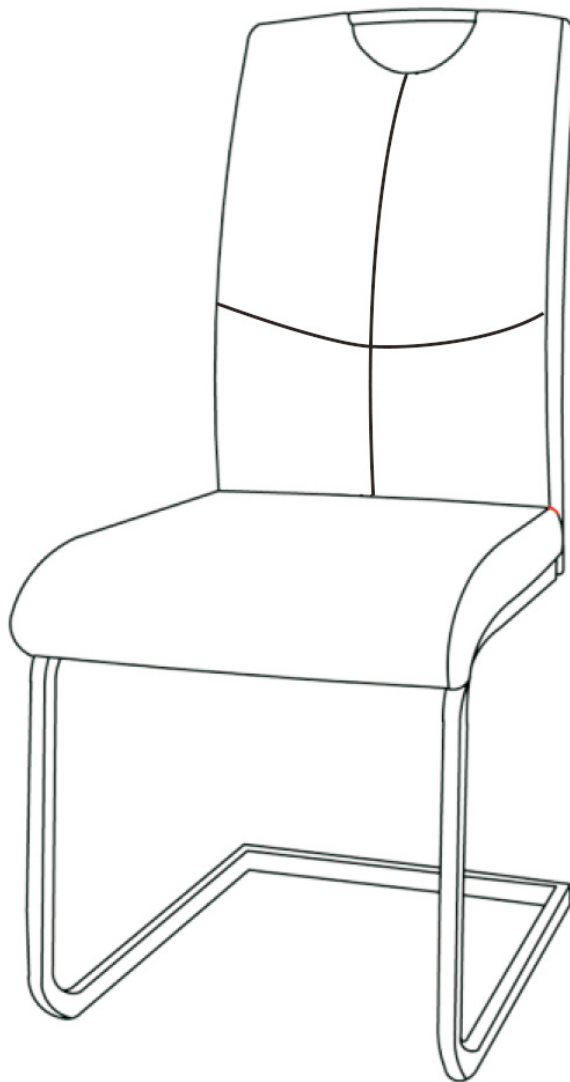

3 - CLEANING AND MAINTENANCE

- Do not use corrosive or abrasive for cleaning products.
- Clean with a soft cloth
- Don't interfere with metal objects in a mechanism, so that they are threatened with serious deterioration.