

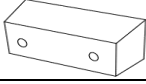

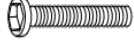

ASSEMBLY INSTRUCTION







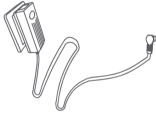
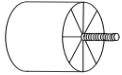



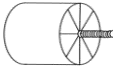

MODEL: HY-8105

Before you beginning ,please follow below Assembly Instruction step by step.

Packing List

NO.	DESCRIPTION	QTY (pcs)		NO.	DESCRIPTION	QTY (pcs)
A		3		E		10
B		2		F		2
C		1		G		1
D		8				

Step 1

- | | | | | | | | | |
|---|---|-------|---|---|-------|---|---|-------|
| A |  | 1 PCS | D |  | 4 PCS | A |  | 2 PCS |
| B |  | 1 PCS | | | | B |  | 1 PCS |
| D |  | 3 PCS | | | | C |  | 1 PCS |
| E |  | 4 PCS | | | | D |  | 1 PCS |
| F |  | 1 PCS | | | | E |  | 6 PCS |
| G |  | 1 PCS | | | | F |  | 1 PCS |

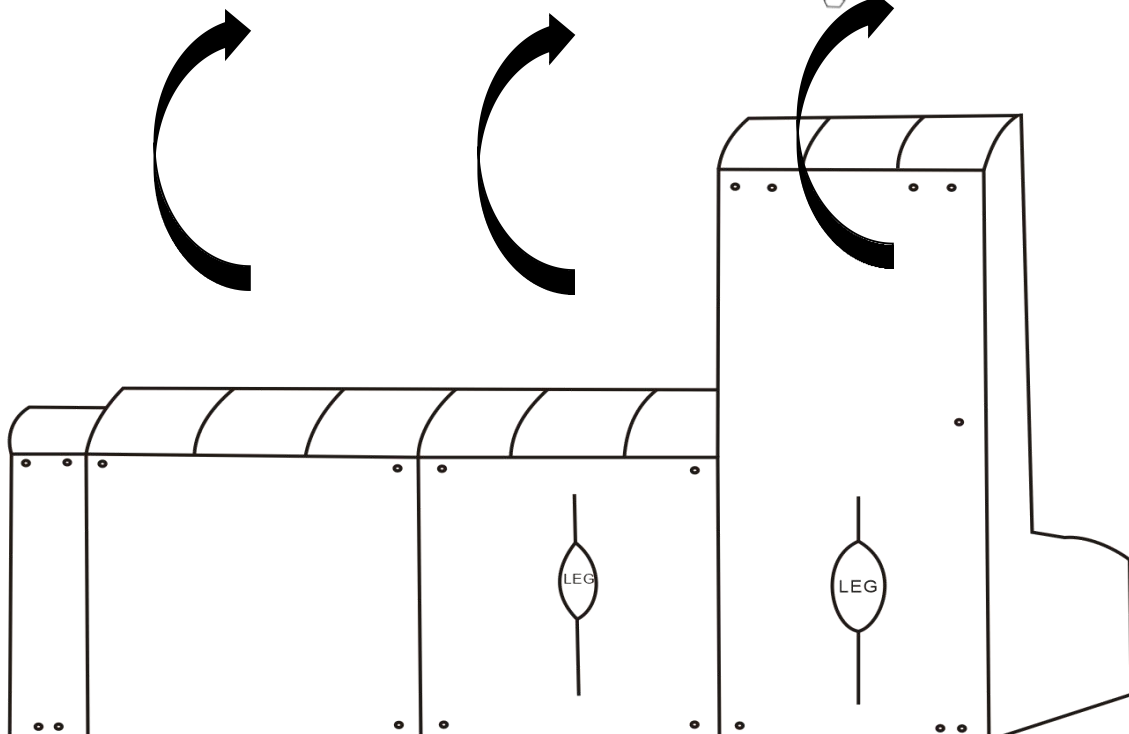

Step 2

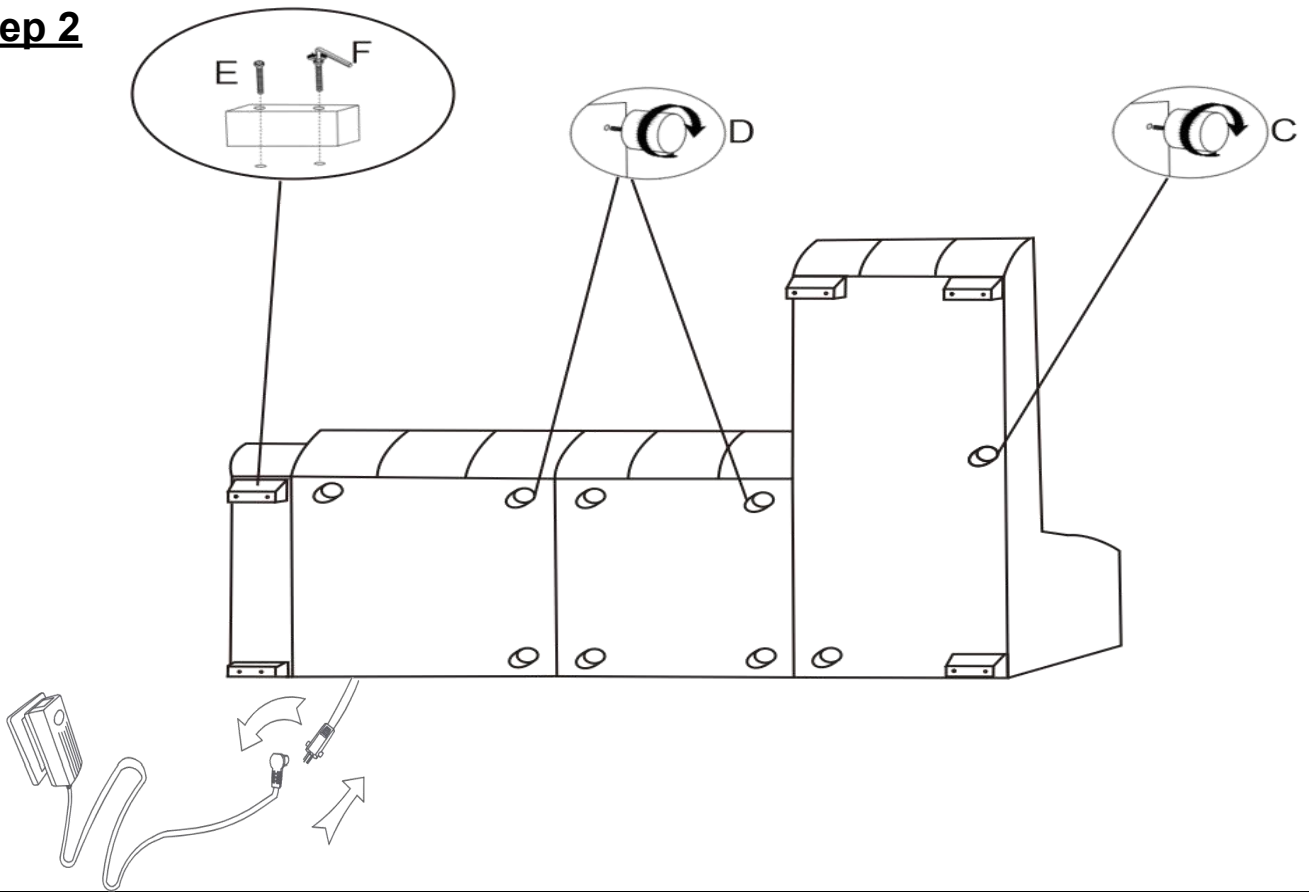

Step 3

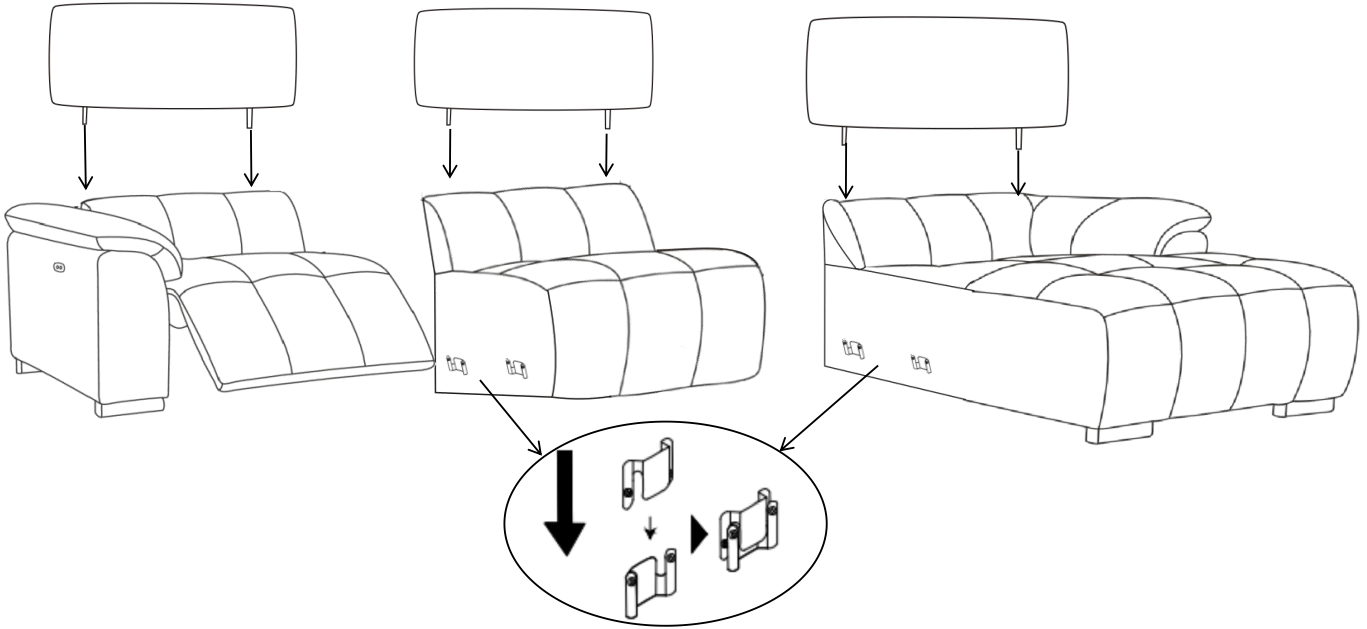

Step 4

