

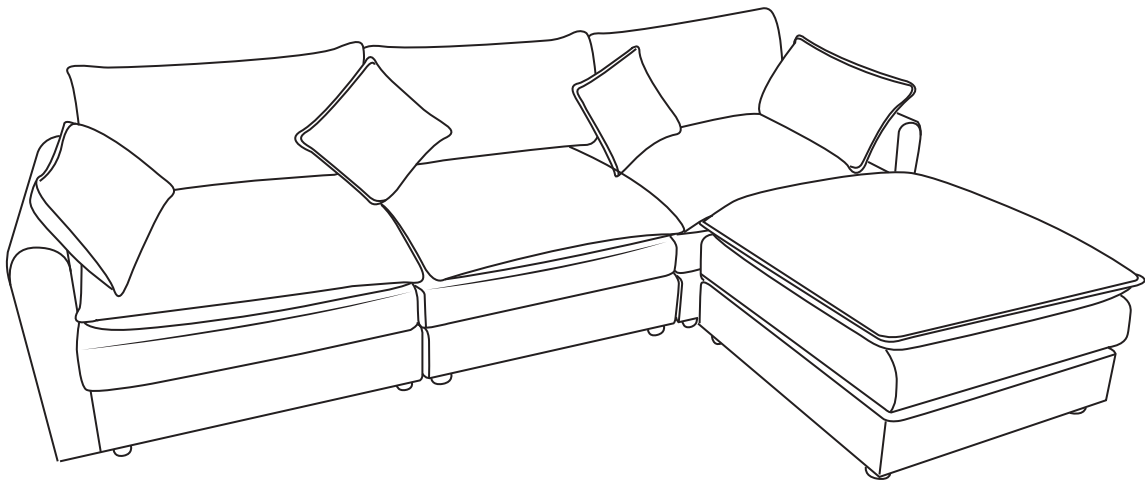
# **ASSEMBLY INSTRUCTION**

---

NH-927

Friendly Reminder:

- 1.This sofa is packed in 3 boxes. Please assemble it After all boxes are received.
- 2.As the cushions are all vacuum compressed,there will be some wrinkles.Please give your cushions up to 72 hours to reach its original size and the wrinkles will basically disappear.
- 3.Please do not open the compressed packags until your sofa frame is completely assembled.




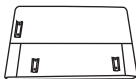

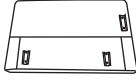



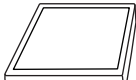





Return & Warranty policy:

- We strive to offer the highest quality products,and we also try our best to satisfy each and every customer that orders from us with replacement parts or service as needed.
- If the item is damaged or defective, please take photos as evidence for replacements and refunds.
- Please do not return to store,contact the seller if you have any troubles with this product.

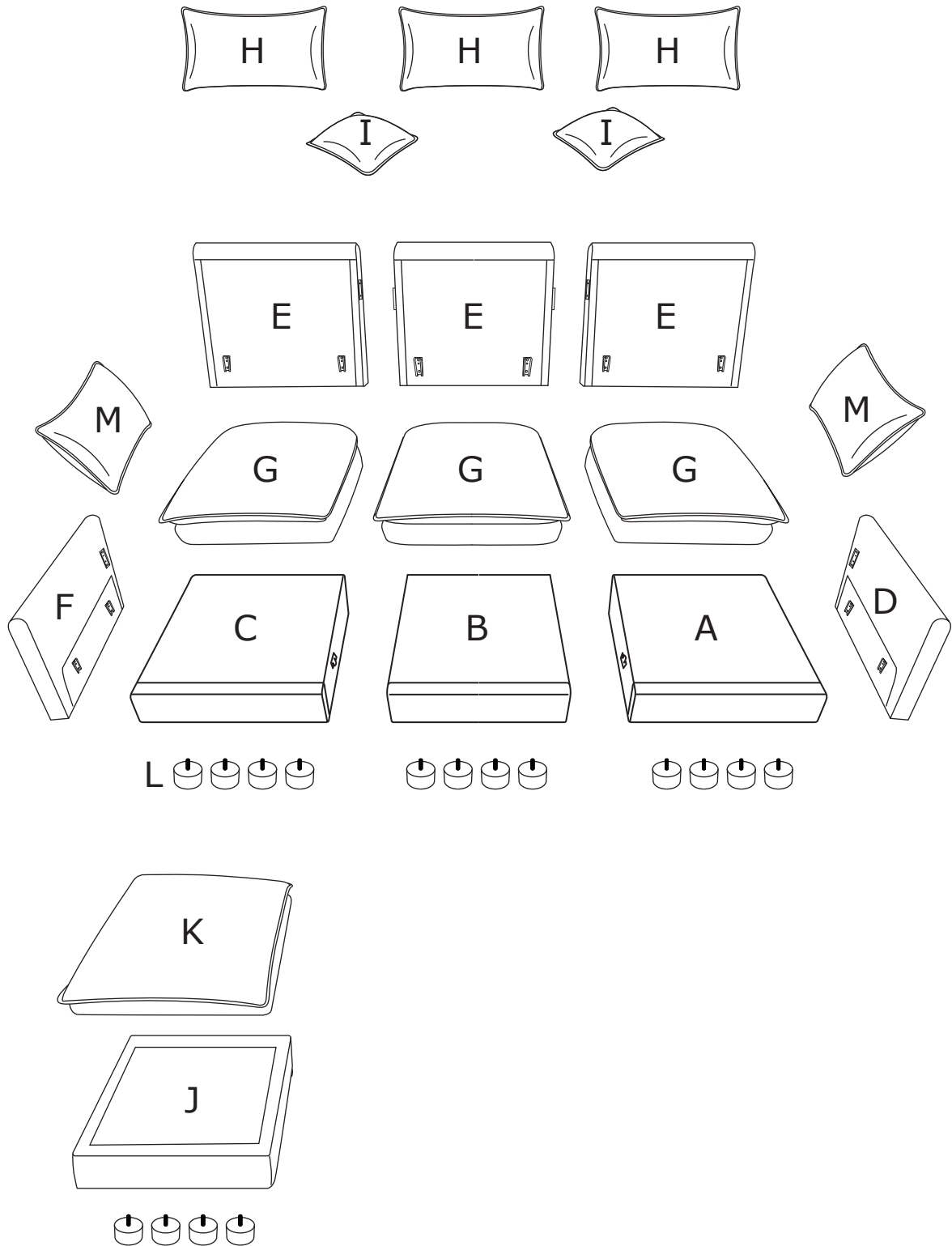
# ASSEMBLY INSTRUCTION

## PARTS LIST NH-927

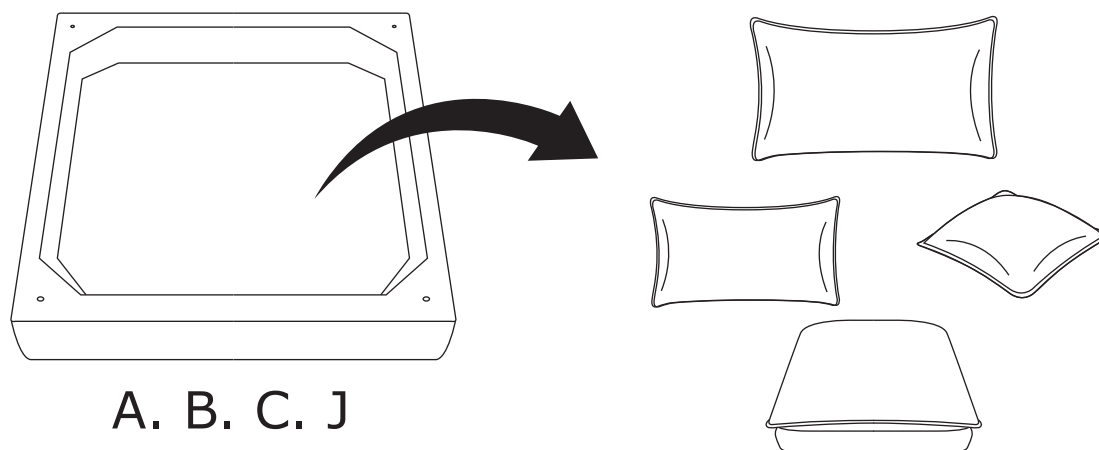
NO	DESCRIPTION	SKETCH	QTY
A	Seat frame		1
B	Seat frame		1
C	Seat frame		1
D	Right Armrest		1
E	Back frame		3
F	Left Armrest		1
G	Seat cushion		3
H	Back cushion		3
I	Pillow		2
J	Foot stool		1
K	Footstool cushion		1
L	Leg		16
M	Long pillow		2

# ASSEMBLY INSTRUCTION

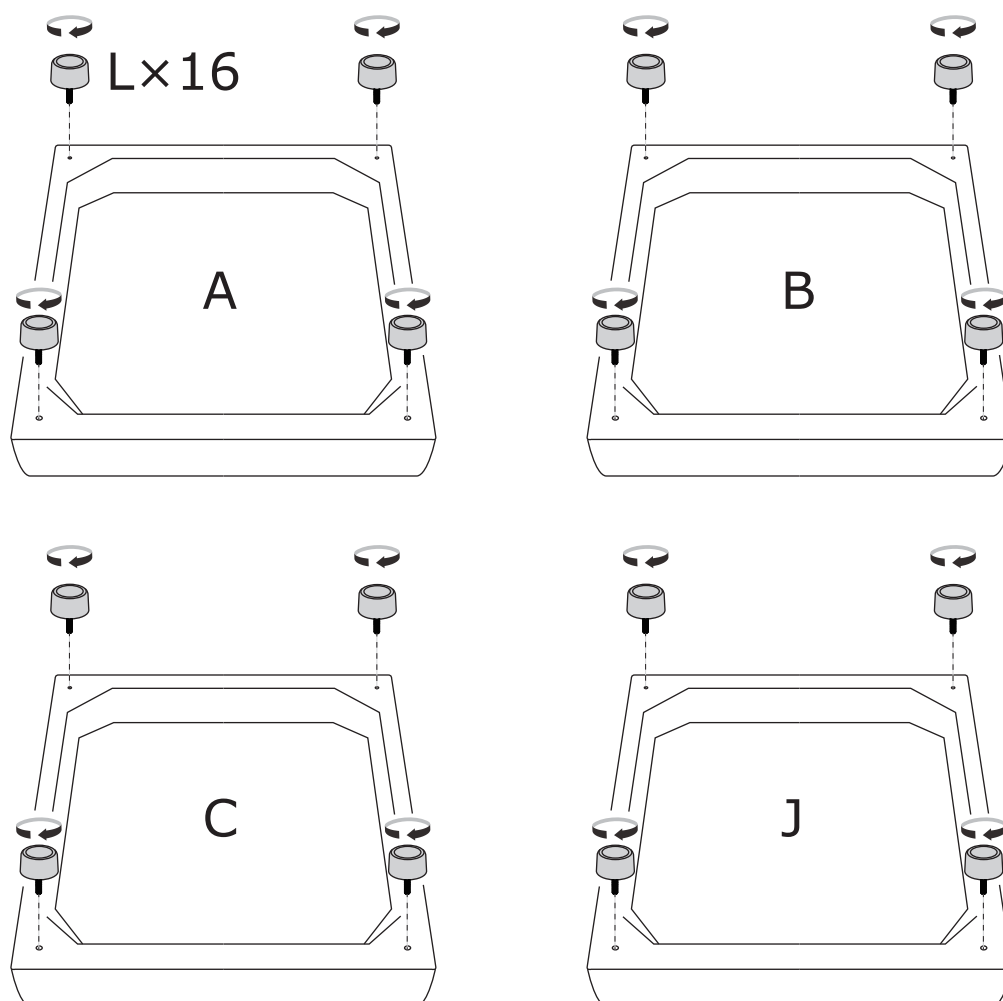
All parts and hardware.



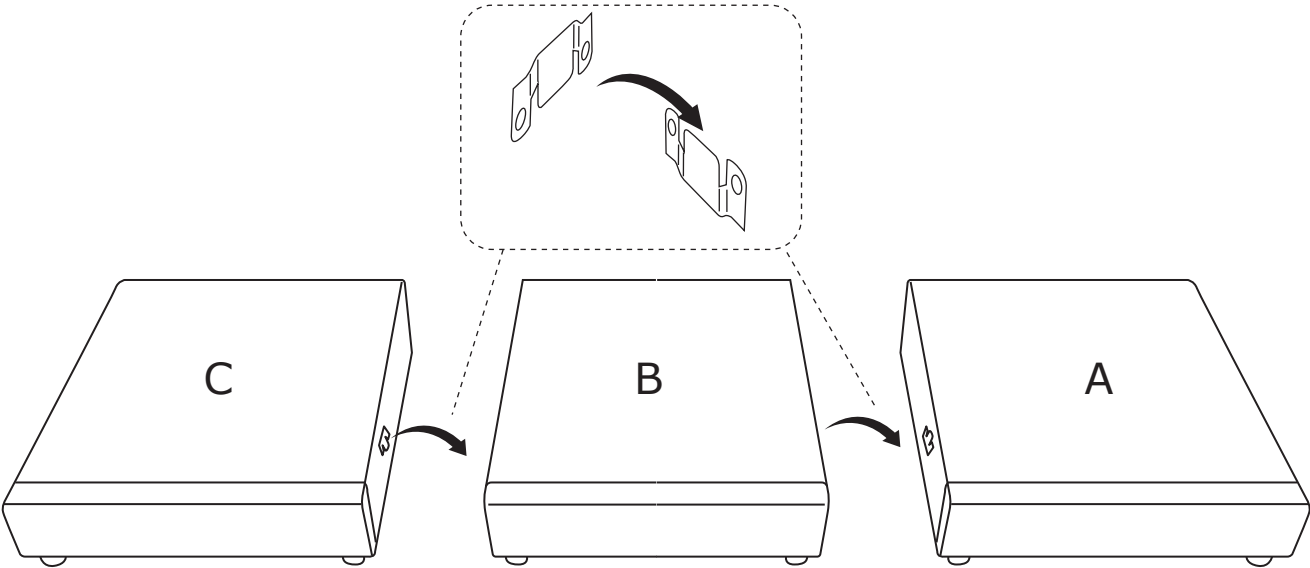
**DIAGRAM 1** :Take out Back cushion and Arm Pillow.



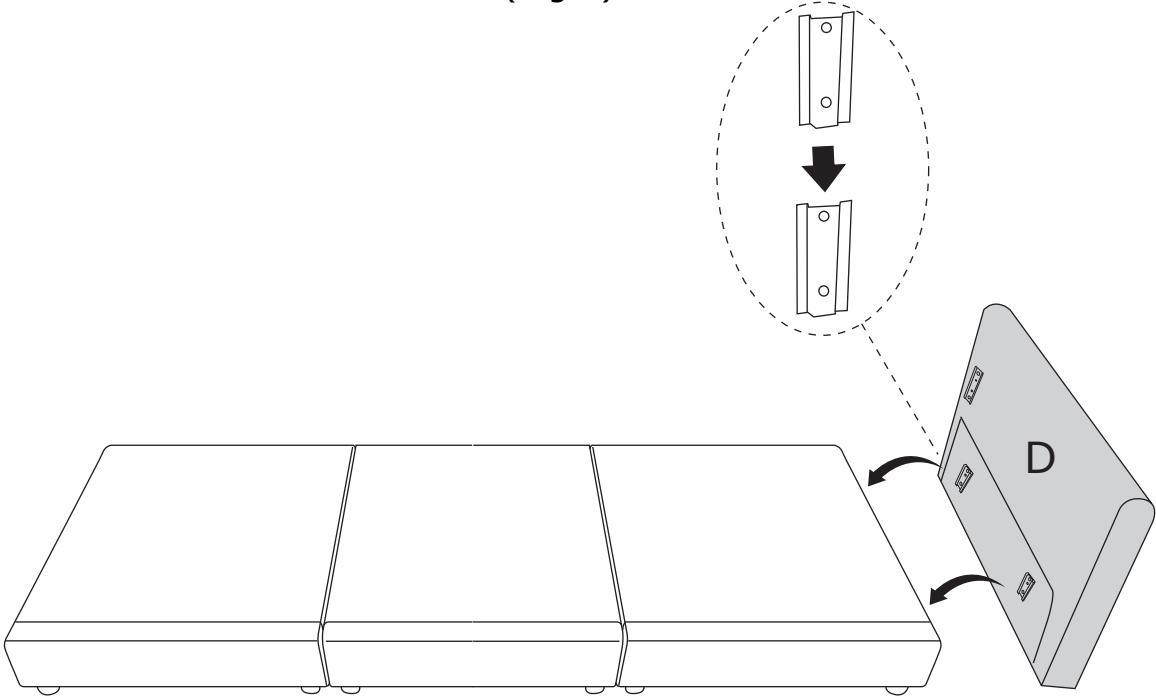
**DIAGRAM 2** :Assemble the Leg.



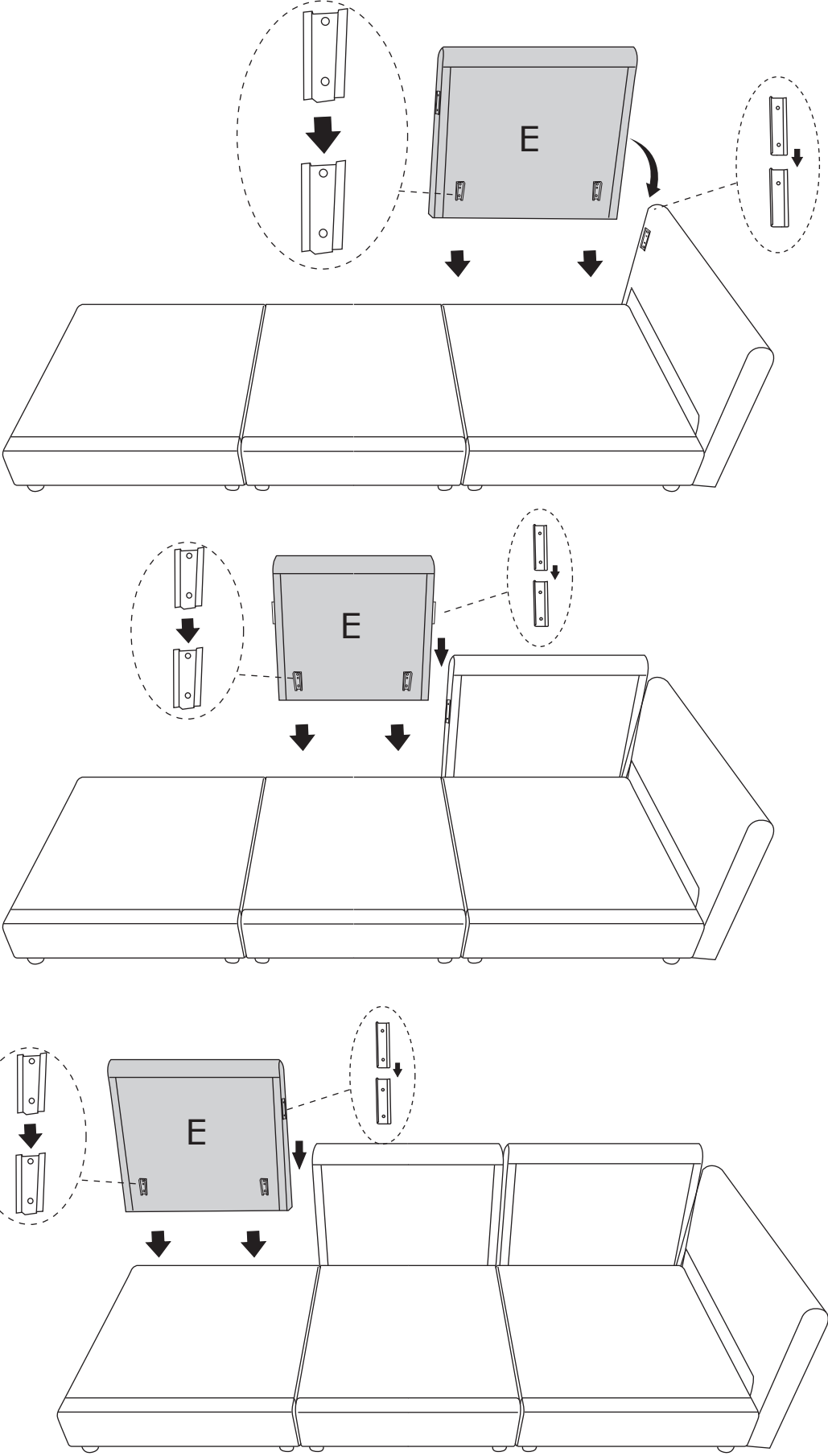
**DIAGRAM 3** :Assemble the Seat frame.



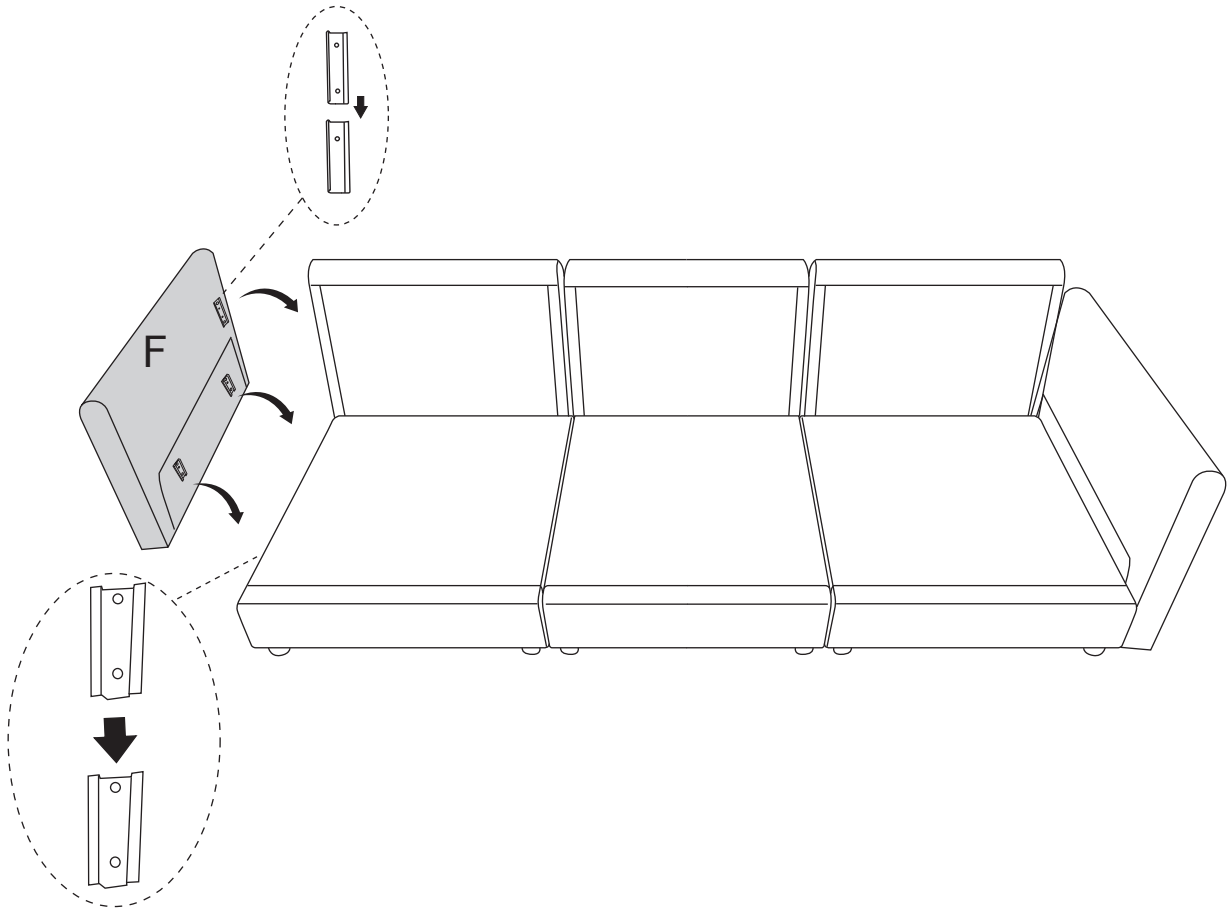
**DIAGRAM 4** :Assemble th Armrest (Right).



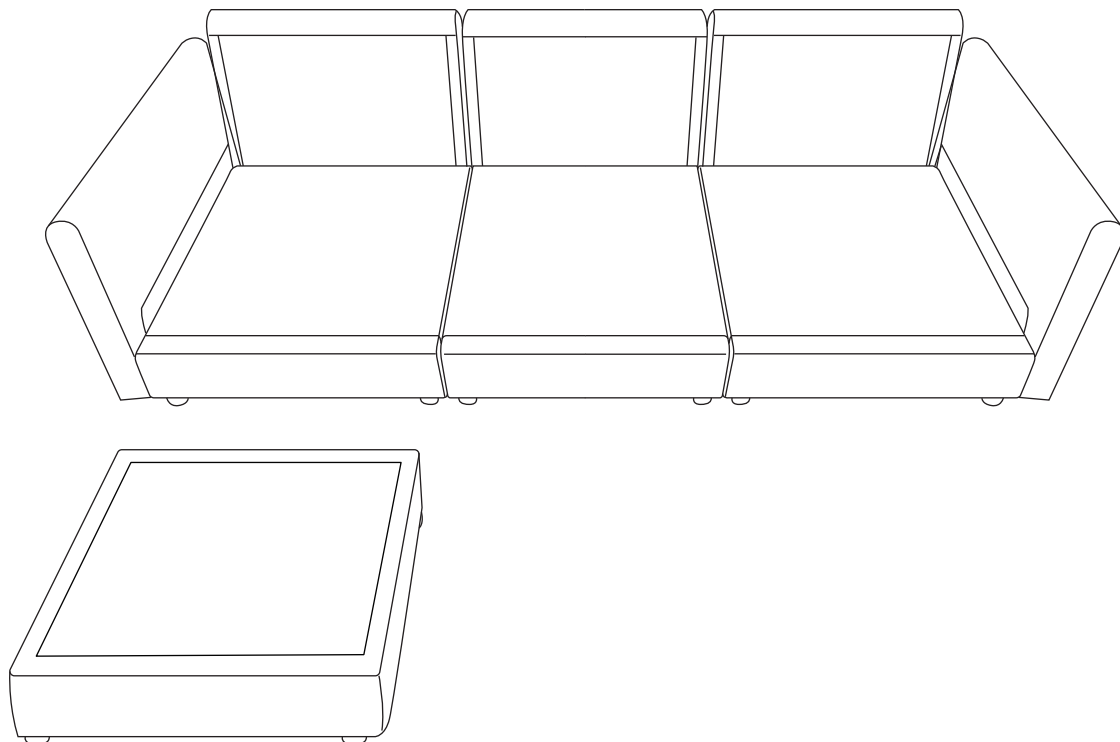
**DIAGRAM 5** :Assembled back



**DIAGRAM 6** :Assemble th Armrest (Left).

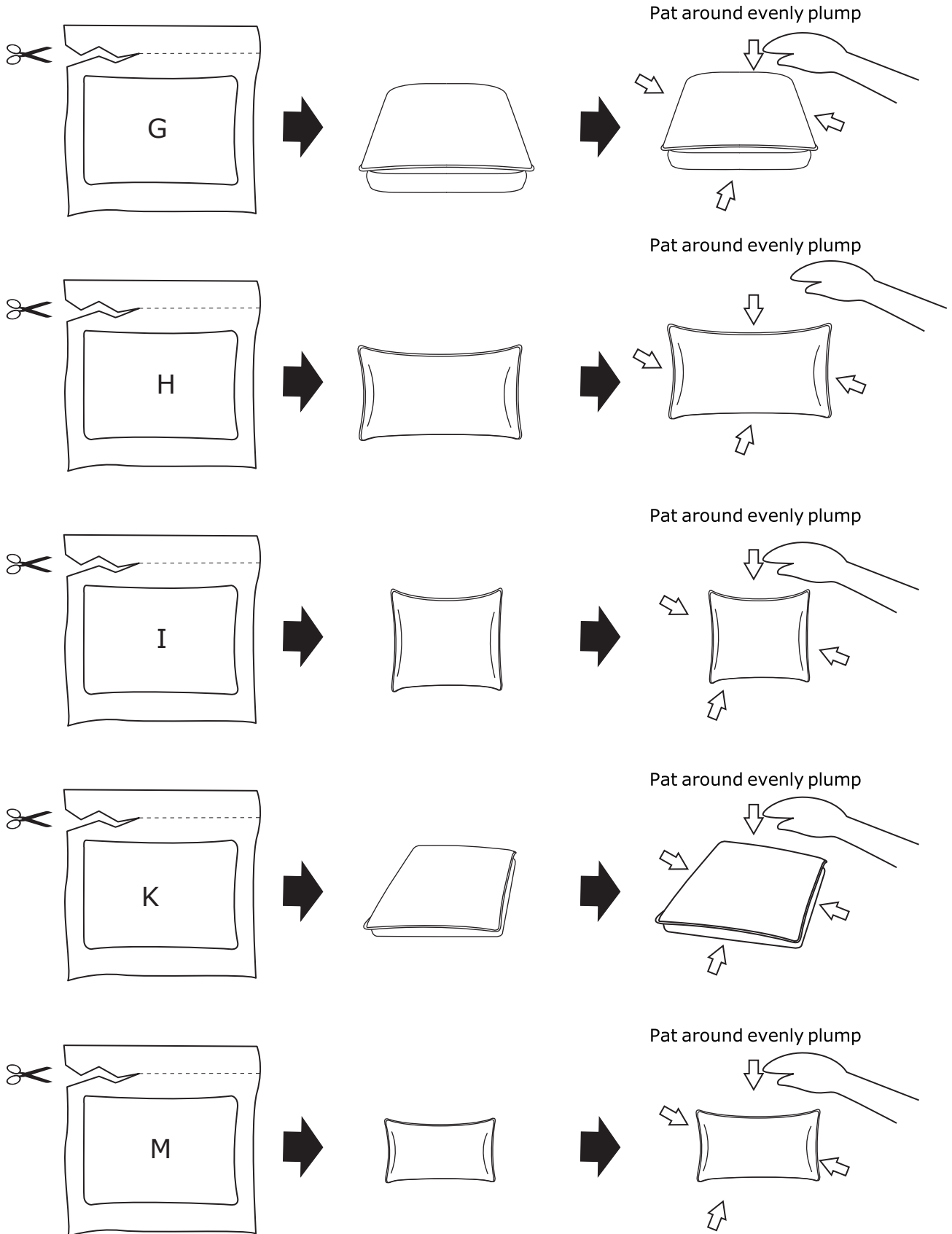


**DIAGRAM 7** :The frame of the sofa has been assembled. Next, assemble the cushions and back cushions.



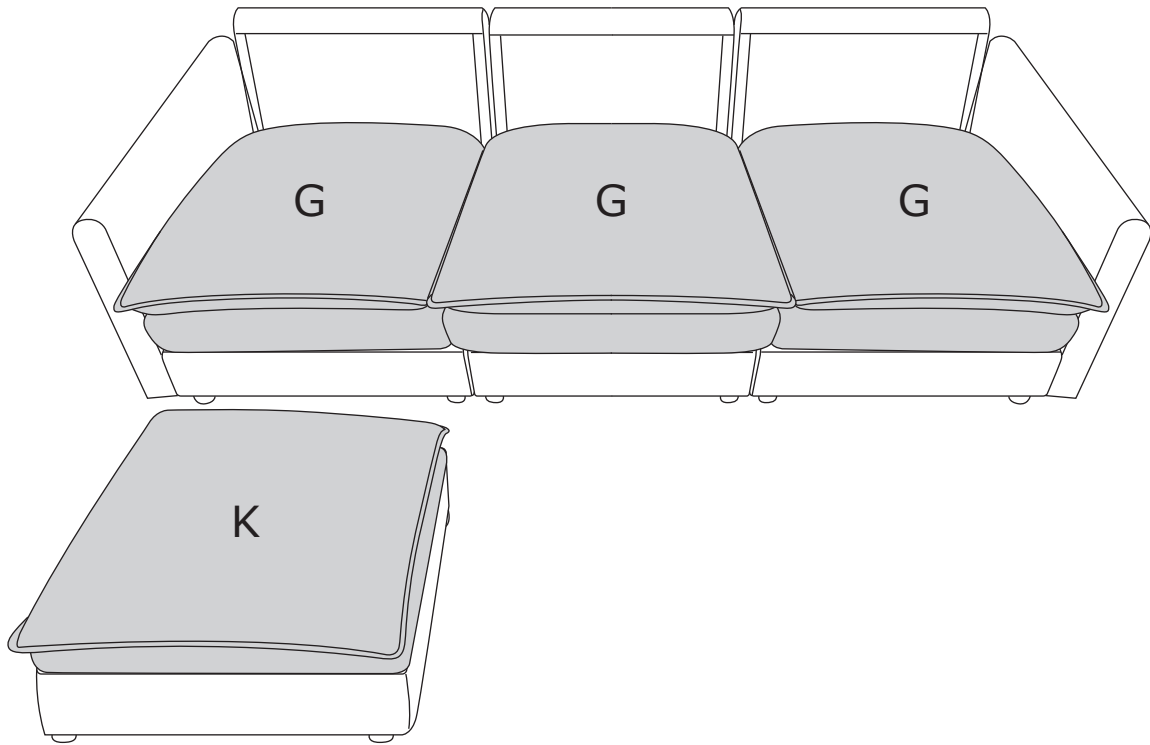
**DIAGRAM 8:**

The cushions is packaged by vacuum compression. After cutting the package, it rebounds quickly within 4 hours. If the fabric has wrinkles, it will basically disappear after standing for 72 hours

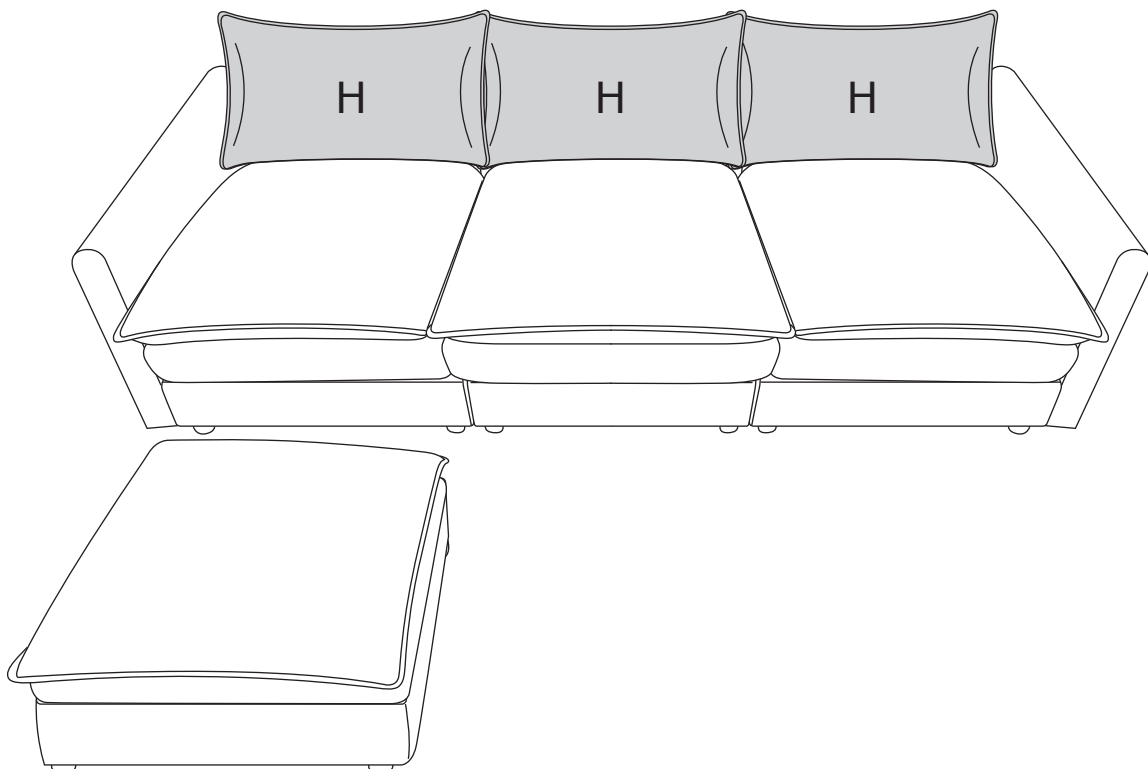




**DIAGRAM 9** :Assemble the cushion.



**DIAGRAM 10** :Assemble the back cushion.



**DIAGRAM 11:** Assemble Pillow and Long pillow.



**DIAGRAM 12:** Assembly complete

**TIPS:**

1. Please do not open the compress packaging until your sofa frame is completely assembled.
2. Compress back cushions and pillows need to be fully fulfilled within 72 hours for your perfect use.
3. Please keep children away from plastic bags or any small pieces of stuff.

