

# INSTRUCTION MANUAL

Model: A02



Please scan the code to watch the installation video  
After-sales Support: [info@i-plus.com](mailto:info@i-plus.com)

## Attention:

Thank you very much for your purchase.

When the number of your order is more than 1, we will split your order and ship the goods separately to ensure the safety.

We promise to deliver at the same time, but the time of receipt may be slightly different due to logistics.

Each tracking number corresponds to only one cargo, you can contact [info@i-plus.com](mailto:info@i-plus.com) for more logistics information. Thanks again for your understanding.

# PARTS LIST



① X1

Left side panel  
14.4\*13.1\*0.6in



② X1

Right side panel  
14.4\*13.1\*0.6in



③ X1

Left trim panel  
13.1\*1.96\*0.6in



④ X1

Right trim panel  
13.1\*1.96\*0.6in



⑤ X1

Rear trim panel  
18.03\*1.96\*0.6in



⑥ X1

Main panel  
19.3\*13.1\*0.6in



⑦ X1

Front trim panel  
19.3\*2.56\*0.6in



⑧ X2

Support panel-1  
7.1\*4.92\*0.6in



⑨ X2

Support panel-2  
13\*4.92\*0.6in



⑩ X1

Fixed panel  
19.3\*13.1\*0.6in



⑪ X1

Front skirting panel  
18.03\*3.15\*0.6in



⑫ X1

Rear skirting panel  
18.03\*2.36\*0.6in



⑬ X1

Back panel  
18.43\*12.44\*0.16in



⑭ X2

Drawer left  
9.85\*3.15\*0.6in



⑮ X2

Drawer right  
9.85\*3.15\*0.6in



⑯ X2

Drawer back  
15.83\*3.15\*0.6in



⑰ X2

Drawer bottom  
16.22\*9.6\*0.16in



⑱ X2

Drawer front  
19.05\*5.9\*0.6in

# HARDWARE LIST

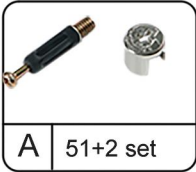

**A** 51+2 set  
Cam Bolt & Cam Lock  
F7\*31 F15\*11

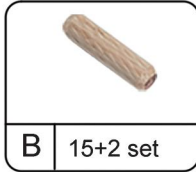

**B** 15+2 set  
Wood Dowel  
F8\*30

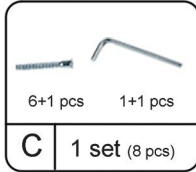

**C** 1 set (8 pcs)  
6+1 pcs 1+1 pcs  
Screw & Allen Key  
F5\*40

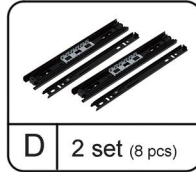

**D** 2 set (8 pcs)  
Slide rail  
F20\*250

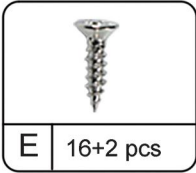

**E** 16+2 pcs  
Screw  
F3.5\*14

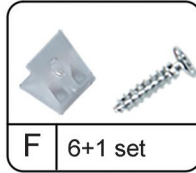

**F** 6+1 set  
Rear panel hook & Screw  
F3\*14

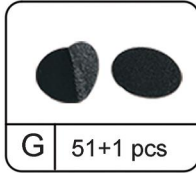

**G** 51+1 pcs  
Hole cover  
F20

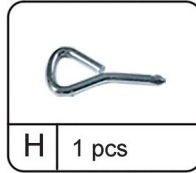

**H** 1 pcs  
Screw driver

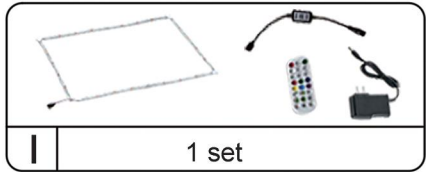

**I** 1 set  
Light strip



**Spare** 5 pcs  
Insert nut  
F10\*11  
If the nut is missing from the panel,  
use a hammer to drive in the spare nut.



## Attention:

1. Please place the product on the carpet or carton to assemble to avoid scratching the floor;
2. During the installation process, keep away from children and pets, and avoid accidentally swallowing spare parts;
3. It is recommended to use a low-speed electric drill for installation.

# INSTRUCTION MANUAL

Step 1

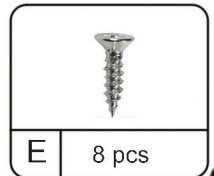
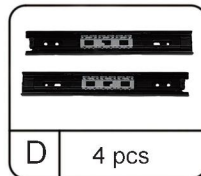
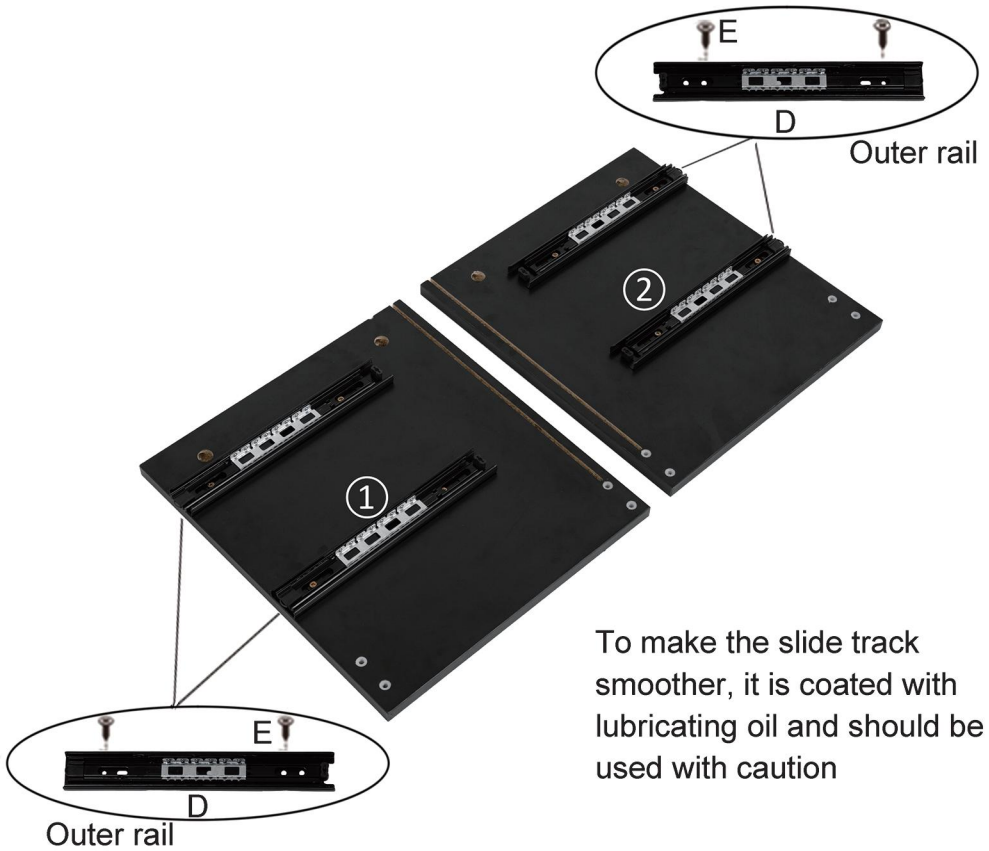

# INSTRUCTION MANUAL

## Step 2

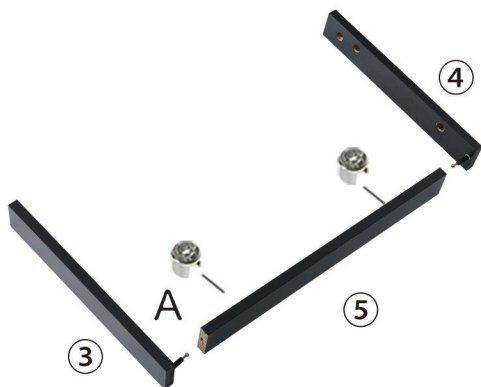

(Attention: Cam bolt & Insert nut need to be put together)

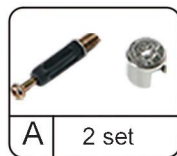

## Step 3

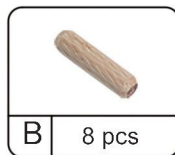
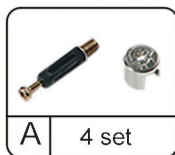
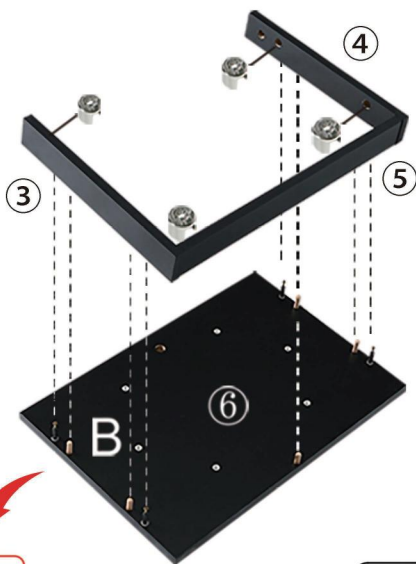

# INSTRUCTION MANUAL

## Step 4

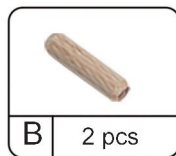
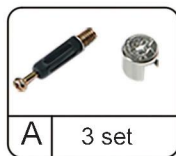
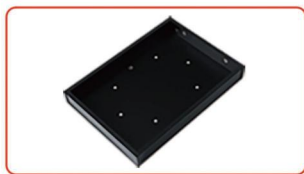
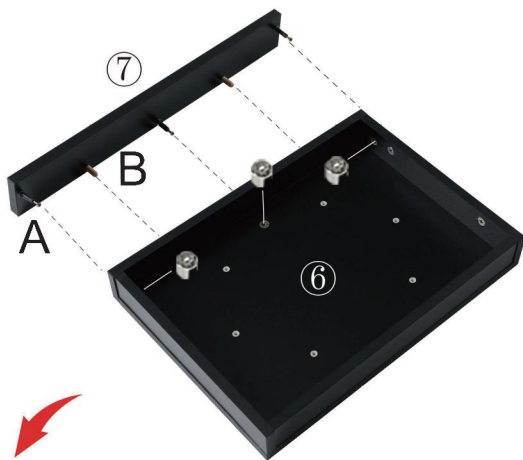

## Step 5

Note: the direction of ⑧, ⑨

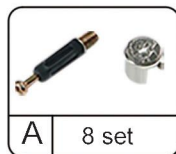
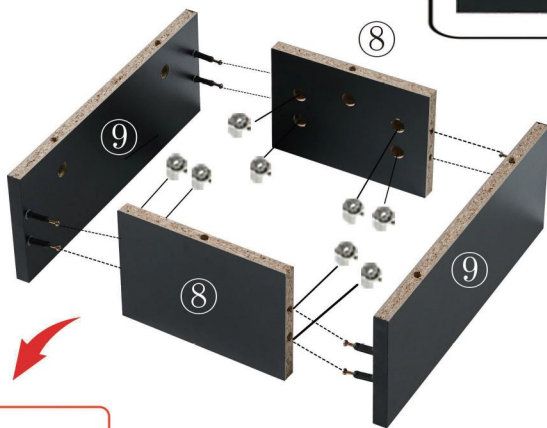

# INSTRUCTION MANUAL

## Step 6

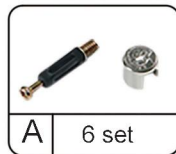
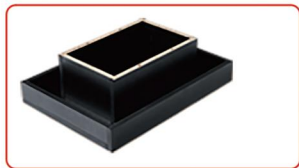
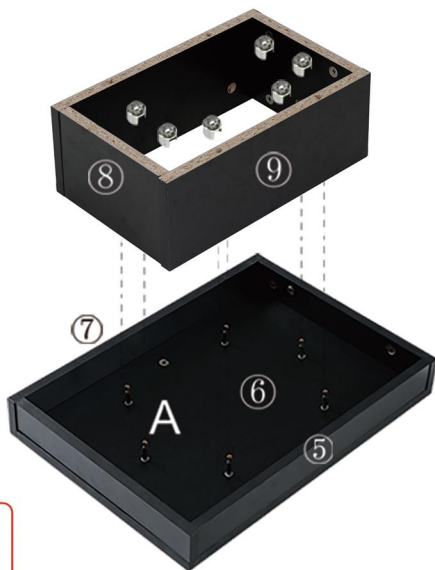

## Step 7

Stick light strip to the ⑥

Note1: The direction of the light strip.

Note2: After the Light strip is pasted incorrectly, it should be gently removed to prevent damage.

Note3: When the light strips are connected to each other, the plus sign "+" must correspond, please ignore the letter "RGB".

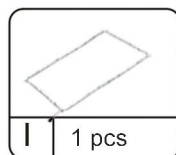
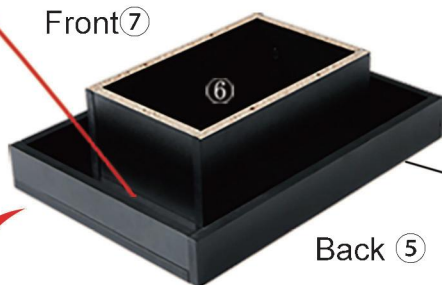

# INSTRUCTION MANUAL

## Step 8

Use the Allen key from the parts kit to screw the screws into the plate in a clockwise direction.

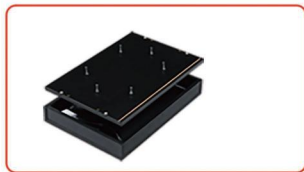
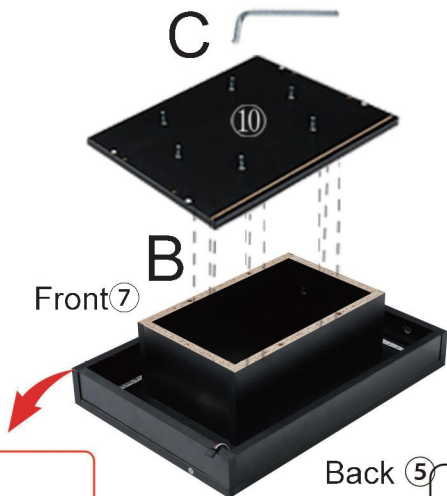

Back (5)

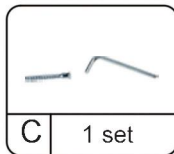
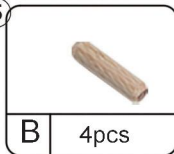

## Step 9

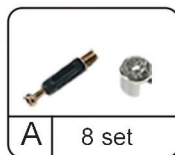
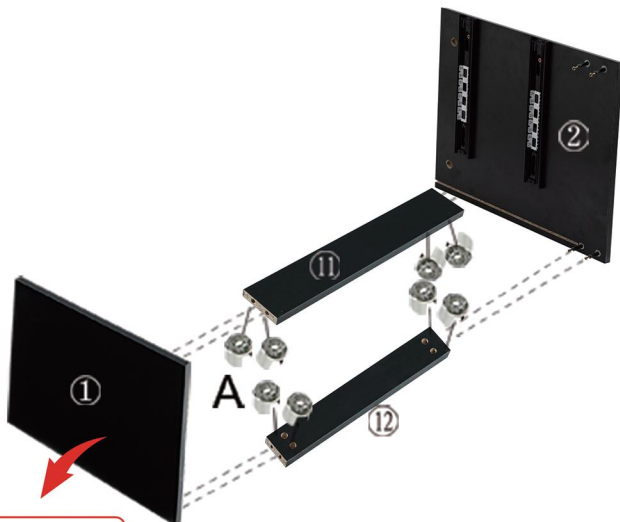



# INSTRUCTION MANUAL

Step 10



Step 11

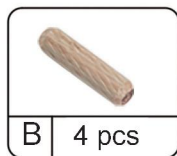
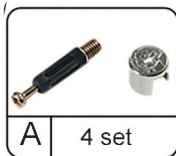

# INSTRUCTION MANUAL

Step 12 X2

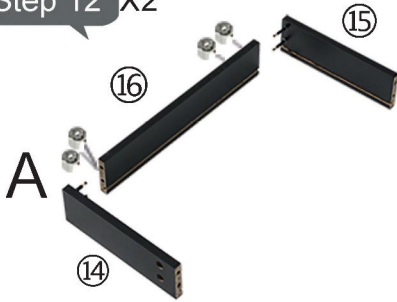

1. Connect part 14&15 to 16



2. Insert part 17

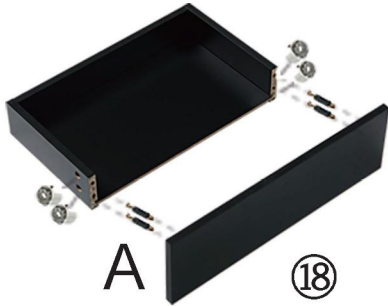

3. Connect part 18



4. Install hardware "D" to part 14 & 15 according to the pre-drilled holes

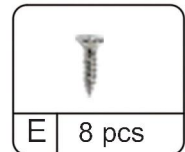
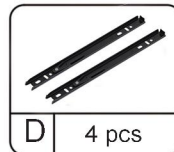
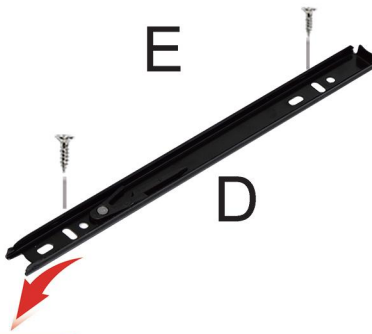

# INSTRUCTION MANUAL

Step 13

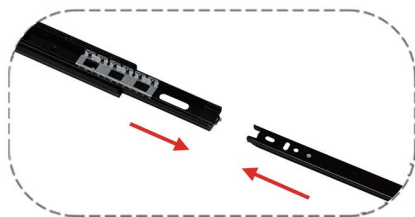

Step 14



As the picture shows,  
fix hardware "F" into the gap with screws  
to make the back panel more stable.

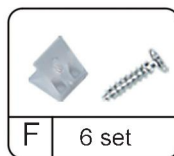

Step 15

## Attention:

- The plastic cover prevents the light strip interface from falling off from the controller.
- You can operate the advanced remote control in any direction to switch mode or light.



1. If the plastic cover falls off, connect the light strip plug to the adapter socket correctly



2. Take out the remote control gasket



## Step 16

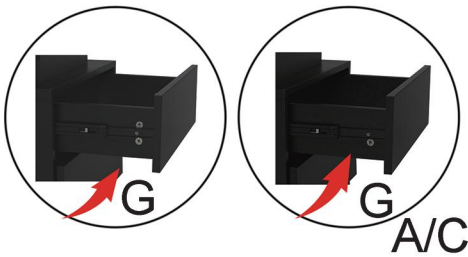
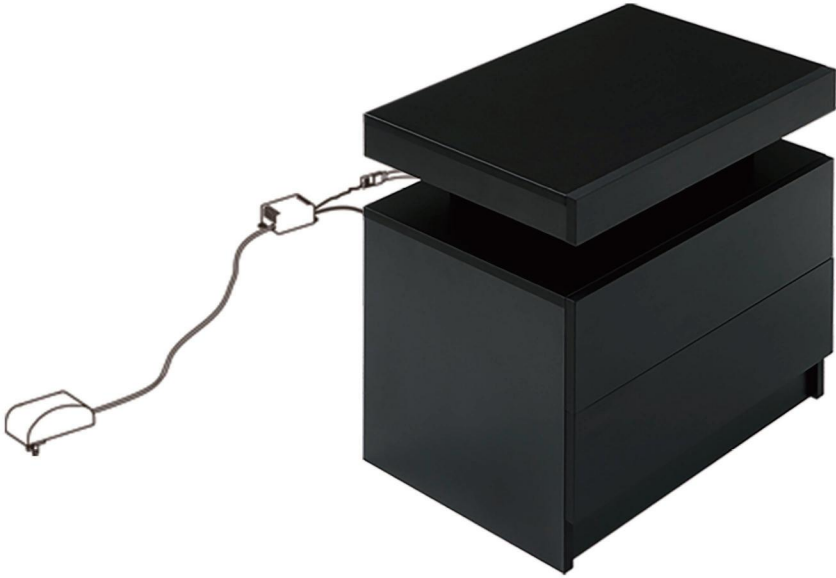

Please stick the hardware "G" on the exposed cam lock hole that makes your product more beautiful.

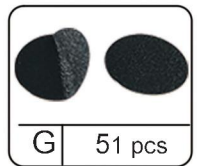



**Congratulations on successful installation!!!**