

Ceiling Fan

Installation Instructions

Retain this manual for future use.

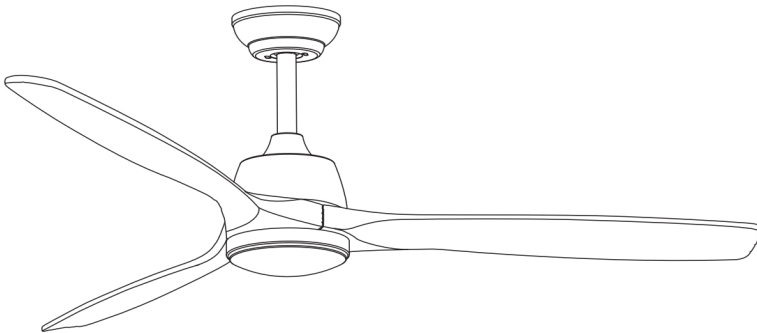
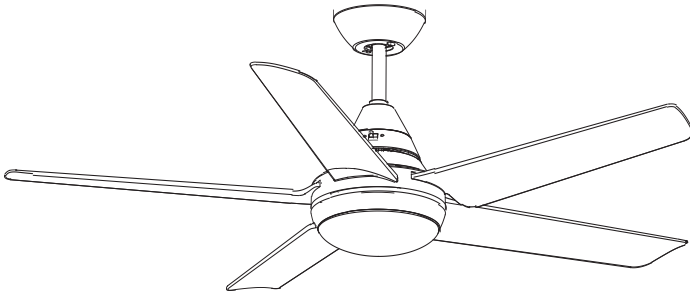

We appreciate the trust and confidence you have placed in us through the purchase of this ceiling fan.

We strive to continually create quality products designed to enhance your home.

Thank you for choosing us!

Table of contents

Table of contents	1
Safety Precautions	2
Warranty	3
Pre-Installation	
Tools needed	3
Specification	4
Installation	
Step 1(Basic assembly of the fan)	5
Step 2 (Ceiling bracket installation)	7
Step 3 (Receiver and wiring installation)	8
Step 4 (Light kit and blades installation)	9
Step 5(Switch on and ceiling fan works)	10
Remote Control (Emitter) Operation	11
TroubleShooting	12

Reminder-QR code for your quick & convenient watching on Page 13

Safety Precautions

The information contained in the following pages has been prepared to ensure your maximum enjoyment of your fan

Please remove the fuse or turn off the circuit breaker to cut off the power before installing the fan. Ensure all electrical connections are in compliance with local laws, regulations and national electrical codes. If you are not familiar with electrical installation and wiring, please hire a qualified electrician or consult the wiring manual.

1. For your safety, all electrical connections and disconnections should be performed by a qualified electrician.
2. Any action performed for the electrical connection of the device must be carried out after ensuring that the general power supply is disconnected, by removing the corresponding fuse or disarming the protective switch in order to ensure total isolation of the power supply.
3. When deciding where to mount the fan, be sure that there is at least 30 inches (76 cm) of space between the fan and any wall or other obstruction that the fan blades could collide with. The greater this distance, the more effective the air flow produced. After the fan is mounted, be sure that the blades are no less than 7ft (2.1 m) above the ground.
4. The anchor point for the fan must be able to support a weight of at least 100 pounds (45 kg). If mounting on a ceiling junction box, be sure that the fan is adequately supported to prevent loosening or turning.
5. The fan's electrical connection must be "grounded" (the fan's ground cable connected to the installation's grounding network) in order to avoid any branching that may be dangerous to people.
6. Do not connect the fan's power supply to any dimmers, potentiometers, or light switches, as it will cause the fan to malfunction and/or will damage the motor. The fan must be directly connected to a properly protected installation circuit (magnetothermal differential switch with the adequate size for the fan's consumption and technical specifications). Only use the fan's control to turn it on or stop it.
7. It is recommended to not use these types of fans along with gas installations simultaneously in the same room.
8. The fan must not be moving and must have come to a complete stop before changing its direction of rotation. This will prevent damage to its motor and to the control unit, when applicable.
9. Do not insert anything that could hit the fan's blades into its pathway while it is moving, as this could cause damage to people, can damage the blades, and can offset the balance of the unit, causing vibrations and wobbling.
10. After installing the fan, ensure that all fastenings are secure and tightened in order to avoid any noise caused by loose elements.
11. Due to the fan's movement, certain fastenings may become loose. Check all fastenings twice per year at a minimum in order to ensure that they are sufficiently tight. If necessary, they must be retightened.
12. The motor housing can be cleaned with a soft brush or a lint-free cloth to avoid scratching the surface. Clean the blades with a lint-free cloth. Important: Turn off the main power supply before starting any maintenance. Do not clean the fans with water or a damp cloth.

Note: The important warnings and instructions indicated in this manual are not guaranteed to cover all possible conditions and situations that may occur. It must be understood that common sense, precaution, and care are factors that cannot be included in all products. These factors can and must only be provided by the user who maintains and enjoys this fan.

Warranty

The manufacturer warrants the fan motor to be free from defects in workmanship and material present at time of shipment from the factory for a period of lifetime after the date of purchase by the original purchaser. The manufacturer warrants the light kit (excluding any glass), to be free from defects in workmanship and material at the time of shipment from the factory for a period of three years after the date of purchase by the original purchaser. The manufacturer also warrants that all other fan parts, excluding any glass or acrylic blades, to be free from defects in workmanship and material at the time of shipment from the factory for a period of one year after the date of purchase by the original purchaser. We agree to correct such defects without charge or at our option replace with a comparable or superior model if the product is returned. To obtain warranty service, you must present a copy of the receipt as proof of purchase. All costs of removing and reinstalling the product are your responsibility. Damage to any part such as by accident, misuse, improper installation or by affixing any accessories, is not covered by this warranty. Because of varying climatic conditions this warranty does not cover any changes in brass finish, including rusting, pitting, corroding, tarnishing or peeling. Brass finishes of this type give the longest useful life when protected from varying weather conditions. A certain amount of "wobble" is normal and should not be considered a defect. Servicing performed by unauthorized persons shall render the warranty invalid. There is no other express warranty. We hereby disclaim any and all warranties, including but not limited to those of merchantability and fitness for a particular purpose to the extent permitted by law. The duration of any implied warranty which cannot be disclaimed is limited to the time period as specified in the express warranty. Some states do not allow limitation on how long an implied warranty lasts, so the above limitation may not apply to you. The retailer shall not be liable for incidental, consequential, or special damages arising out of or in connection with product use or performance except as may otherwise be accorded by law. Some states do not allow the exclusion of incidental or consequential damages, so the above exclusion or limitation may not apply to you.

This warranty gives specific legal rights, and you may also have other rights which vary from state to state.

This warranty supersedes all prior warranties. Shipping costs for any return of product as part of a claim on the warranty must be paid by the customer.

Pre-Installation

Tools Needed

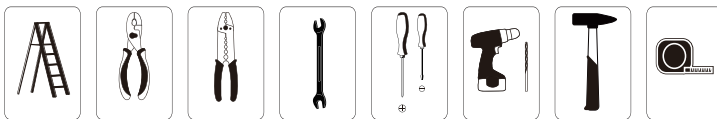

Pre-Installation

Specification

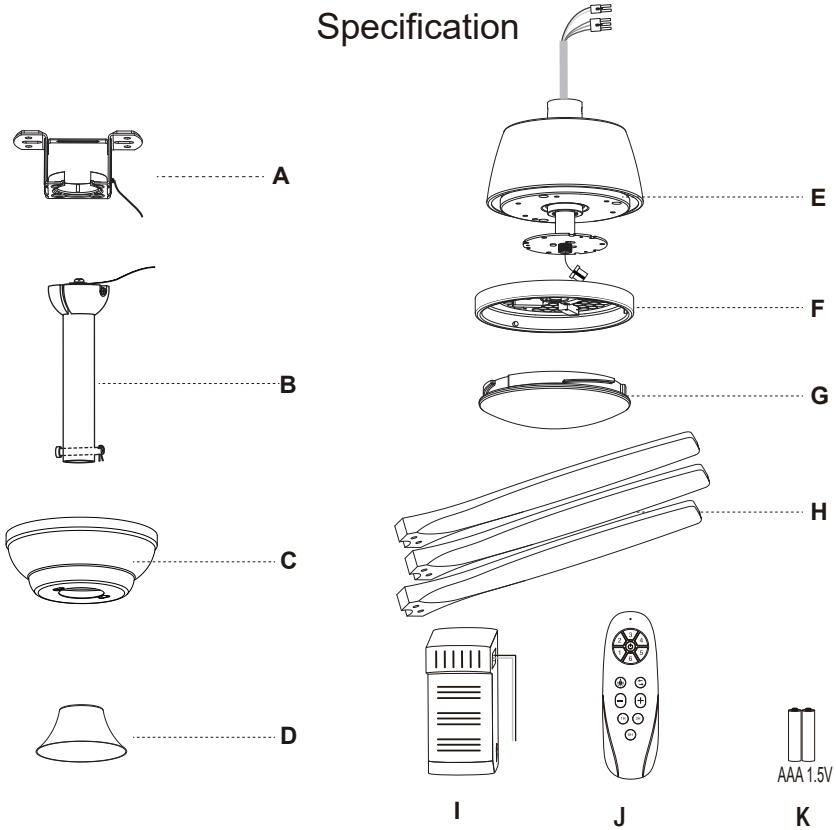

Part	Description	Quantity
A	Bracket	1
B	Down rod	1
C	Canopy	1
D	Yoke cover	1
E	Body/motor	1
F	Light kit	1
G	Light cover	1
H	Blades	3

Part	Description	Quantity
I	Receptor	1
J	Remote control	1
K	Battery Excluded	2

Installation

Step 1(Basic assembly of the fan)

① Decompose Down rod

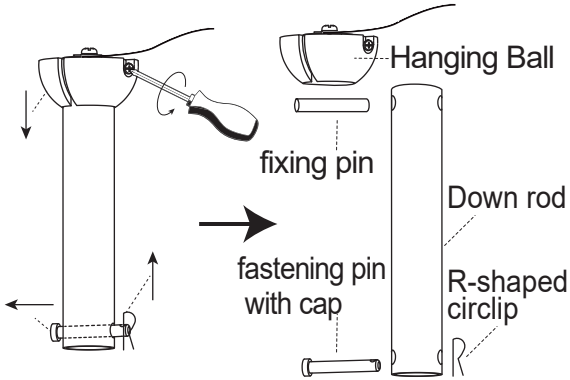

② Pass the cable through the down rod and lock the down rod.

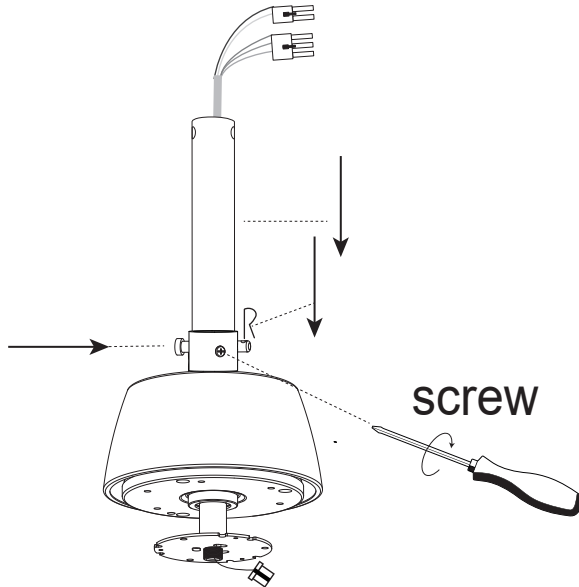

Installation

- ③ Install in order the yoke cover, Canopy, Hanging Ball on the installed Down rod.
slide Hanging Ball down to expose the hole, put the fixing pin into the hole, slide the Hanging Ball up and turn it left and right, let the fixing pin enter the Hanging Ball card slot.

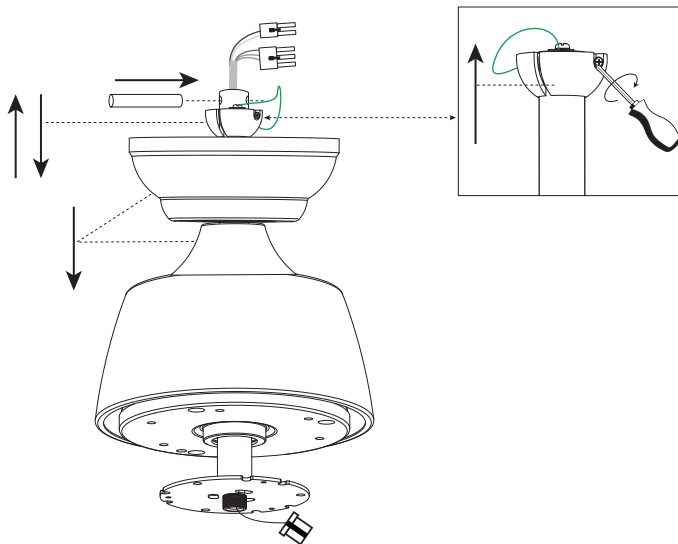

- ④ OK

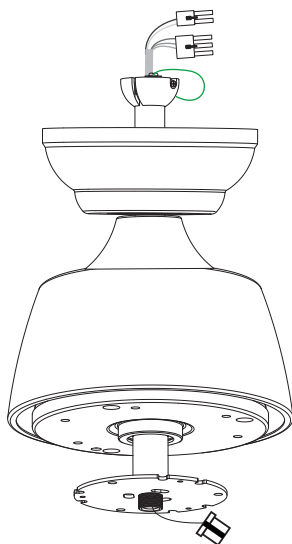

Installation

Step 2 (Ceiling bracket installation and fan into the installed Bracket.)

- ① Turn off the fan power supply at the circuit breaker box and the wall switch.

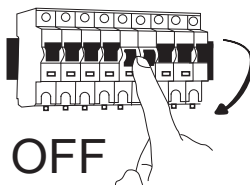

- ② Can be installed on $<15^\circ$ sloped roof.
Choose the following installation methods according to the actual situation of the roof.

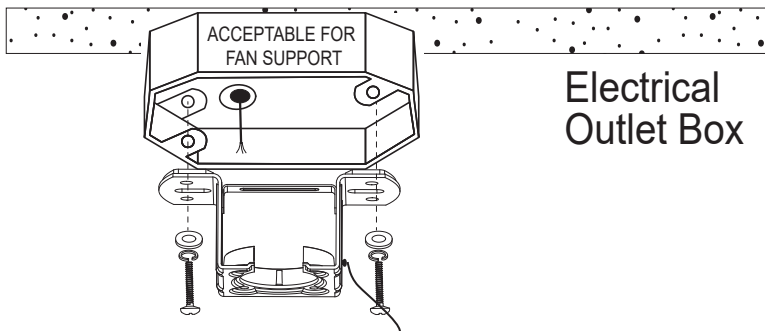

or

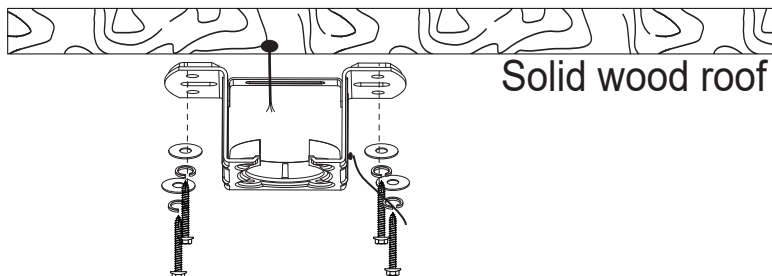

Installation

- ③ Snap the basically assembled fan into the installed Bracket.

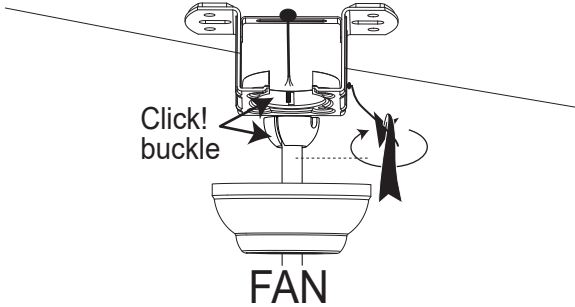

Step 3 (Receiver and wiring installation)

- ① Connect the wires according to the polarity (the color of the House power cord may be different if the color is the same).

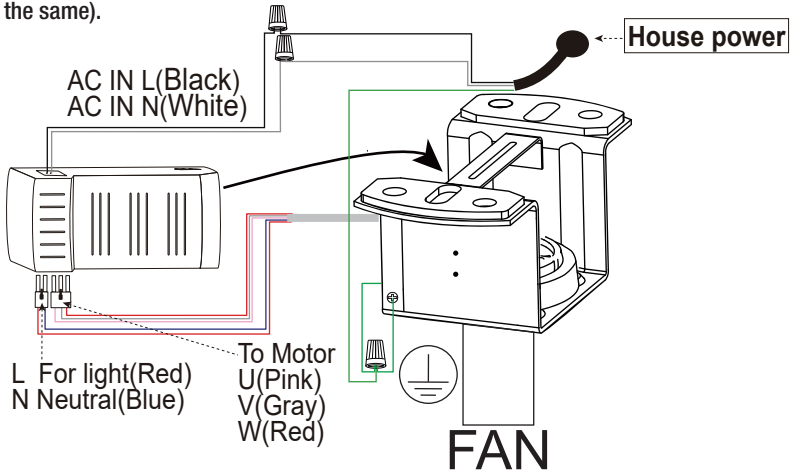

- ② Put the receiver into the Bracket and arrange the wires

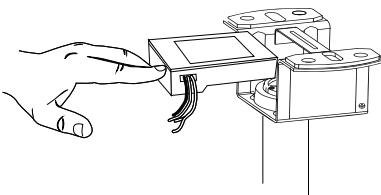

- ③ Adjust the position of Canopy, then lock it

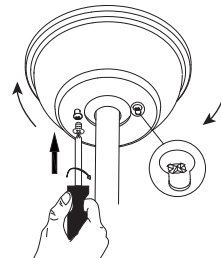

Installation

Step 4 (Blades and Light kit installation)

- ① Align the blades with the mounting holes, and then fix them with screws.

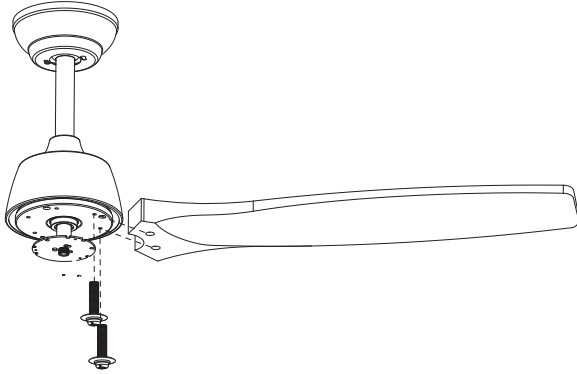

- ② Remove the pre-installed screws. Connect the light kit cable, and then lock the light kit.

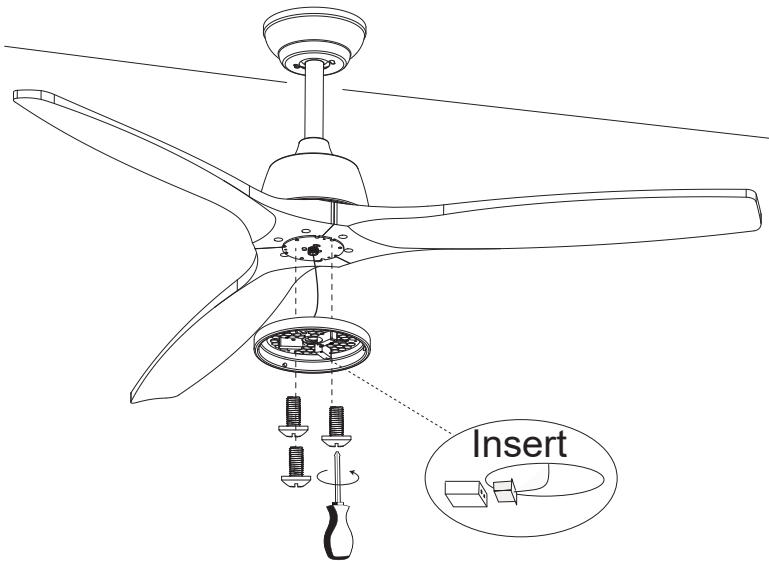

Installation

③ Installation of light cover

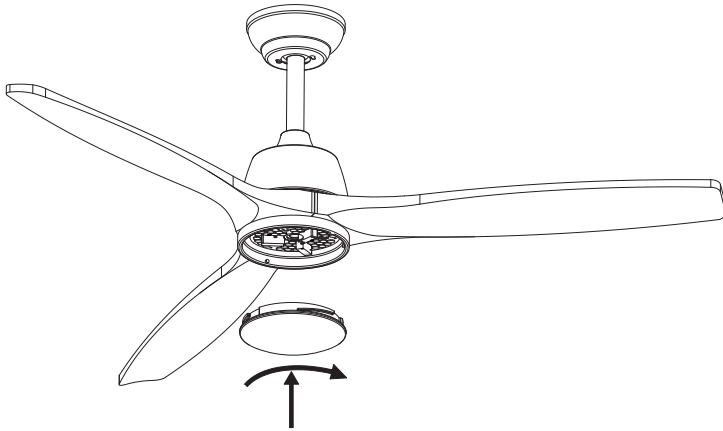

Step 5(Switch on and ceiling fan works)

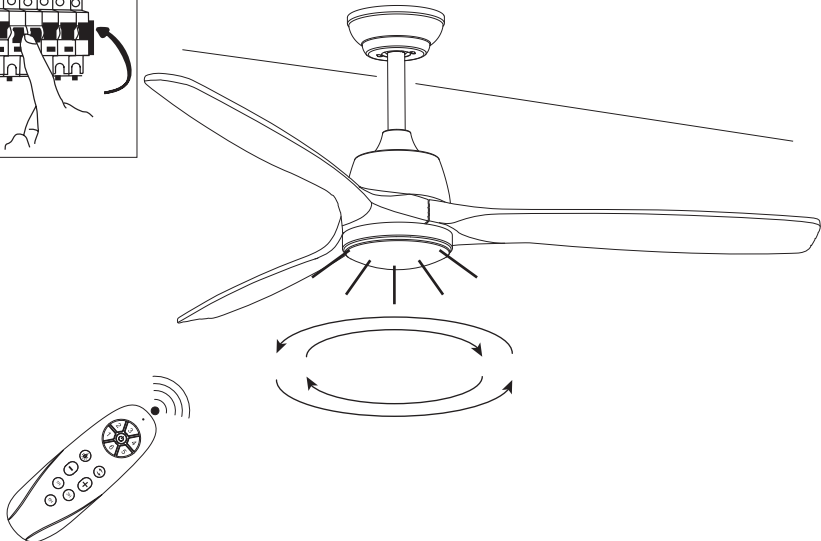
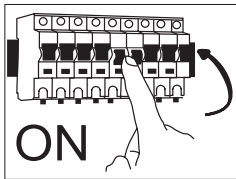

Remote Control (Emitter) Operation

If emitter can not control the fan

1. Please check whether the battery is installed correctly and whether it is charged. If necessary, replace the remote control battery.
2. Please check if there are similar remote control products working nearby, because remote control products of the same frequency will interfere with each other.
3. Please press and hold the “1” and “2” buttons at the same time within 10 seconds after the product is powered on, until you hear two beeps to succeed. If it doesn't work, please try again.

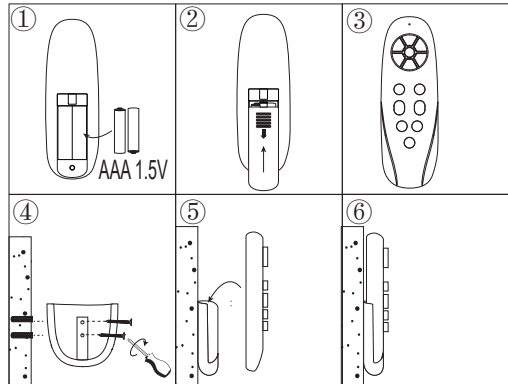

Remote Control

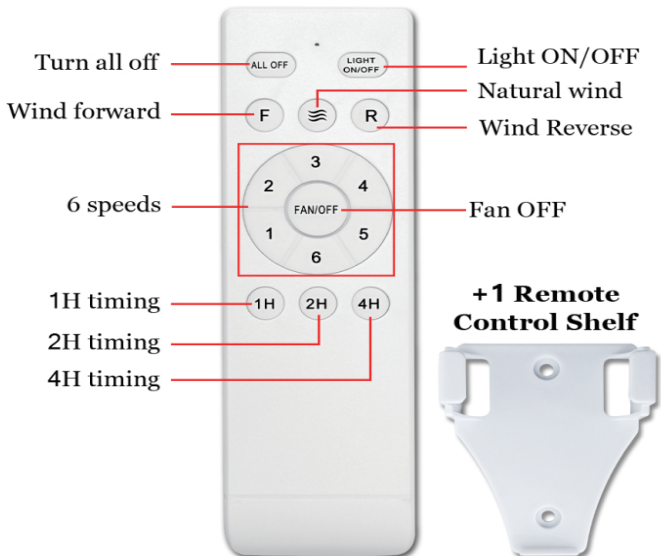

TroubleShooting



WARNING: Make sure the power is off at the electrical panel box before you attempt any repairs.

Problem	Solution
The fan will not start.	<ul style="list-style-type: none"> <input type="checkbox"/> Check the main and branch circuit fuses or breakers. <input type="checkbox"/> Check the line wire connections to the fan and switch wire connections in the switch housing. <input type="checkbox"/> Check to make sure the frequency switches from the remote control and receiver are set to the same frequency.
The fan sounds noisy.	<ul style="list-style-type: none"> <input type="checkbox"/> Make sure all motor housing screws are snug. <input type="checkbox"/> Make sure the screws that attach the fan blade to the motor hub are tight. <input type="checkbox"/> Make sure the wire nut connections are not rattling against each other or the interior wall of the switch housing. <input type="checkbox"/> Allow a 24-hour "breaking-in" period. Most noises associated with a new fan disappear during this time. <input type="checkbox"/> If using the ceiling light kit, make sure the glassware is secured tightly. <input type="checkbox"/> Make sure there is a short distance from the ceiling to the canopy. It should not touch the ceiling. <input type="checkbox"/> Make sure your ceiling box is secure and that rubber isolator pads are used between the mounting bracket and outlet box.
The remote control is not working.	<ul style="list-style-type: none"> <input type="checkbox"/> Do not connect the fan with wall mounted variable speed control(s). <input type="checkbox"/> Make sure the frequency switches are set correctly.
The light is not working	<ul style="list-style-type: none"> <input type="checkbox"/> Check the LED driver is assembled correctly with the LED light source
Parts broken or missing	<ul style="list-style-type: none"> <input type="checkbox"/> Contact vendor for new parts replacement

Installation Guide of ZYS004



Installation Guide of ZYS003



Installation Guide of ZYS002



Installation Guide of ZYS001

