











Assembly Instructions

Caution : You must read this before you proceed





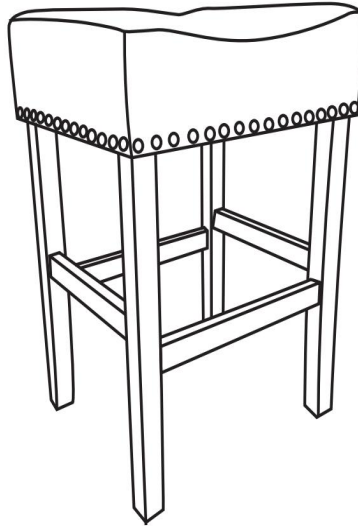

Care & Maintenance

- | | |
|---|---|
|  | <ul style="list-style-type: none">• Not for commercial use. For residential use only. |
|  | <ul style="list-style-type: none">• Furniture may scratch floors. We recommend using furniture pads to protect your floors. |
|  | <ul style="list-style-type: none">• Do not put hot items directly on furniture surface. |
|  | <ul style="list-style-type: none">• Do not clean furniture with harsh cleansers or polish. |
|  | <ul style="list-style-type: none">• Do not place furniture under direct sunlight. |
|  | <ul style="list-style-type: none">• Do not place furniture near heating or cooling vents. |
|  | <ul style="list-style-type: none">• Do not write on furniture without a padded barrier to protect the surface. |
|  | <ul style="list-style-type: none">• Do not place furniture outside . For indoor use only. |
|  | <ul style="list-style-type: none">• Stains may be removed with mild soap solution and damp cloth. |
|  | <ul style="list-style-type: none">• Children should not climb or jump on the furniture. |
|  | <ul style="list-style-type: none">• Dust and pick-up spills using a clean, non-colored, lint-free cloth. |

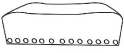





Bar/Counter Stool



Parts List

Label	Picture	Description	QTY
A		Seat	1
B		Left Leg	2
C		Right Leg	2
D		Front Rail	2
E		Side Rail	2
F		Seat Base Cover	1

Hardware

Label	Picture	Description	QTY
①		Bolt (M8*55mm)	9
②		Spring Washer	9
③		Washer	9
④		Allen Wrench	1
⑤		Screw(M4 x50 mm)	9
⑥		Screwdriver	1

Assembly Preparation

Before Beginning Assembly:

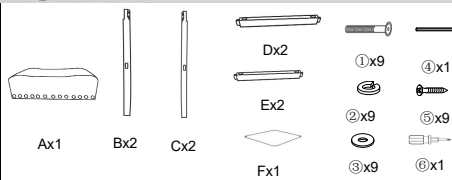

- Read instructions, cover to cover-
- Have 2 adults on hand for assembly-
- Do not assemble on flooring or carpet-
- Assemble on a clean non-marring surface (packing foam)-
- Save all packaging until finished-

Assembly Steps

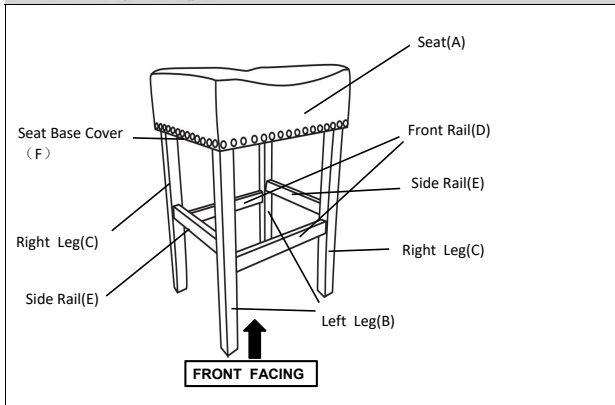

This Bar/Counter Stool has multiple parts and may require up to some 30 minutes to assemble. To give you an overview of the Bar Stool parts, the above picture is to help you put the various parts into perspective. Please read through the instructions herebelow to familiarise the parts and steps before assembly.

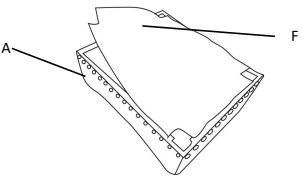
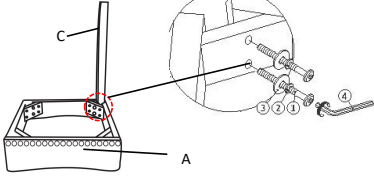
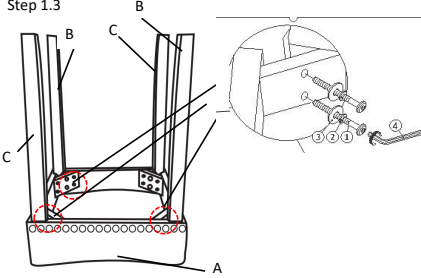
<p>Step 1</p>	<p>Step 1.1</p> 
	<p>Step 1.2</p> 
	<p>Step 1.3</p> 
<p>Place the Seat(A), Right Leg(C) onto a soft surface to avoid any scratches or damages to the product.</p> <p>Step 1.1) Open the Seat Base Cover (F)</p> <p>Step 1.2) Attach the Right Leg (C) to the Bar/Counter Stool Seat (A) and secure with 2 BoltⓄ, 2 Spring WasherⓄ and 2 Flat WasherⓄ per each leg with Allen WrenchⓄ.</p> <p>Step 1.3) Repeat the step of step 1.1, assembly the other Left Leg(B),Right Leg(C) as the picture shown.</p> <p>Do not fully tighten BoltsⓄ on this step.</p>	

Step 2

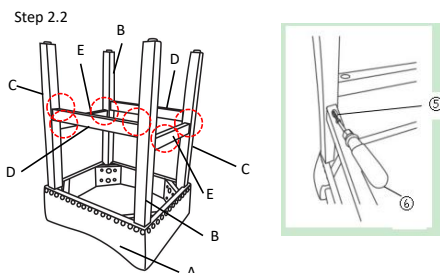
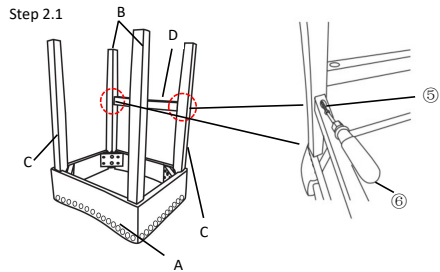

Step 2.1)Insert the Front Rail (D) into round housing of the Right Leg (C) & Left Leg (B) as shown above.
Caution: You may need to apply a little pressure to the leg pushing outwards, so as to enable the Front Rail(D) to be slotted into position. If the distance is not enough, need to go back loose the screw on step 1, makes the foot pole has enough space to insert the rail.
Step 2.2)Secure with 2 ScrewⓄ per each rail (D&E).
Tighten ScrewⓄ only using Screwdriver Ⓞ.

WARNING !! LOOSELY TIGHTEN. OVER TIGHTENING COULD LEAD TO DAMAGE OF THE PRODUCT. TIGHTEN ONLY UNTIL SECURE.

Step 3

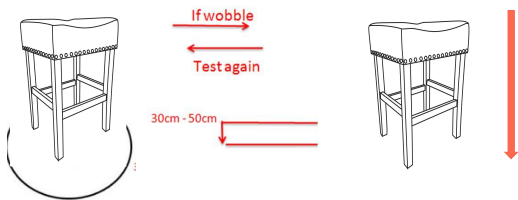

Place the Bar/Counter Stool on a Level Surface to check if it wobbles.
If it wobbles, lift the Bar/Counter Stool some 30cm to 50cm high from the ground, keep your feet and toes well away from the drop zone, and drop the Bar/Counter Stool freely and vertically with the four legs, hitting the ground at the same time.
This Drop Test will help to ensure that all the bolts and gaps to all reach full alignment.
Test again for evenness on Level Surface.
If no wobbles are found, proceed to tighten all the Bolts.

Caution: When tightening the Bolts, tighten sequentially.
Do not tighten any screw fully and then towards the next one, this would cause the frame to warp. If it still wobbles, loosen the bolts and execute this same drop test. If the Bar/Counter Stool is not Stable it could lead to damage to the product.

Step 4

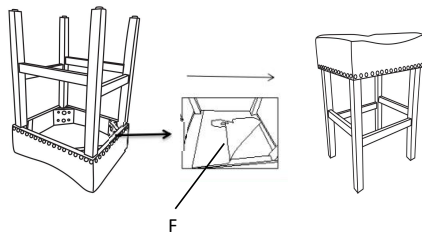

Place the Seat Base Cover(F) back as shown in picture.
Smooth the Seat Base Cover down with your hand on all four sides at the edge of the seat.
Inspect and make sure all parts are connected.
The Bar/Counter Stool is ready for use.

Caution: This bar/counter stool can only be used on a flat, level surface.

Questions & Answers about Proposition 65

- What is Proposition 65?

Proposition 65 requires businesses to provide warnings to Californians about significant exposures to chemicals that cause cancer, birth defects or other reproductive harm. These chemicals can be in the products that Californians purchase, in their homes or workplaces, or that are released into the environment. By requiring that this information be provided, Proposition 65 enables Californians to make informed decisions about their exposures to these chemicals.

Proposition 65 also prohibits California businesses from knowingly discharging significant amounts of listed chemicals into sources of drinking water.

Proposition 65 requires California to publish a list of chemicals known to cause cancer, birth defects or other reproductive harm. This list, which must be updated at least once a year, has grown to include approximately 900 chemicals since it was first published in 1987.

- What types of chemicals are on the Proposition 65 list?

The list contains a wide range of naturally occurring and synthetic chemicals that include additives or ingredients in pesticides, common household products, food, drugs, dyes, or solvents. Listed chemicals may also be used in manufacturing and construction, or they may be byproducts of chemical processes, such as motor vehicle exhaust.

- What does a warning mean?

If a warning is placed on a product label or posted or distributed at a workplace, a business, or in rental housing, the business issuing the warning is aware or believes that it is exposing individuals to one or more listed chemicals.

By law, a warning must be given for listed chemicals unless the exposure is low enough to pose no significant risk of cancer or is significantly below levels observed to cause birth defects or other reproductive harm.

- Where can I get more information on Proposition 65?

If you have specific questions on the administration or implementation of Proposition 65, you can contact OEHHA's Proposition 65 program at P65.Questions@oehha.ca.gov, or by phone at (916) 445-6900.