

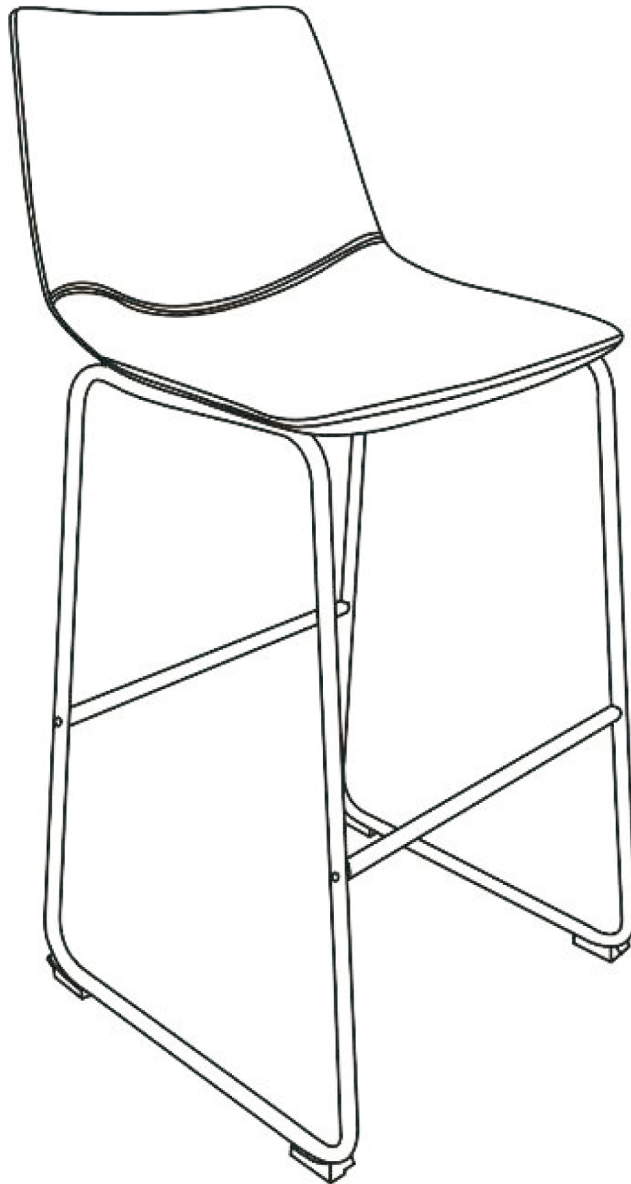



Assembly Instructions

Caution : You must read this before you proceed



BAR STOOL

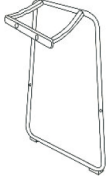

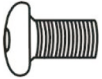

Parts List

Label	Picture	Description	QTY
A		Seat Panel	1
B		Left Leg Panel	1
C		Right Leg Panel	1
D		Support Bar	2

Hardware

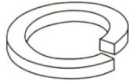
Label	Picture	Description	QTY
①		Short Bolt (M8x14mm)	3
②		Middle Bolt (M6x25mm)	5
③		Long Bolt (M6x30mm)	5

④		Spring Washer	5
⑤		Washer	5
⑥		Allen Key	1

Assembly Preparation

Before Beginning Assembly:

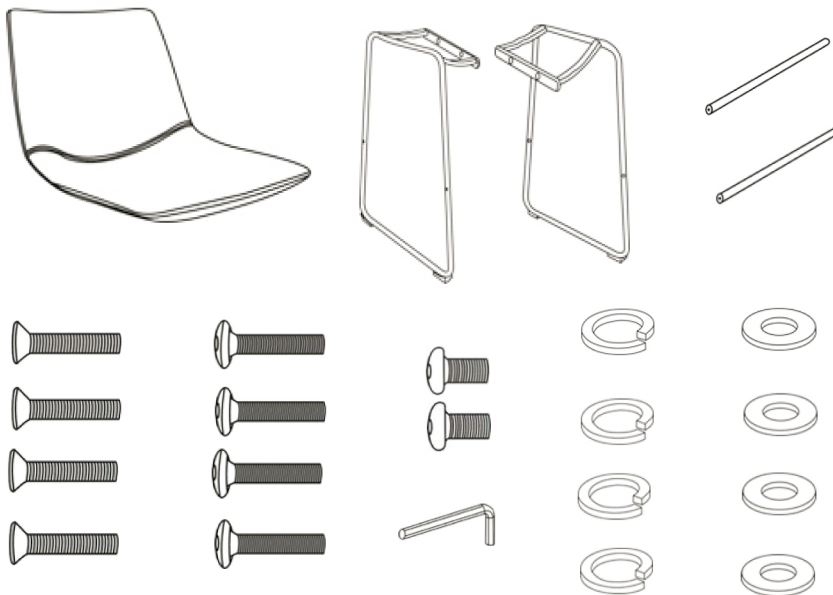

- Read instructions, cover to cover-



- Have 2 adults on hand for assembly-



- Do not assemble on flooring or carpet-



- Assemble on a clean non-marring surface (packing foam)-



- Save all packaging until finished-

Assembly Steps

Overview

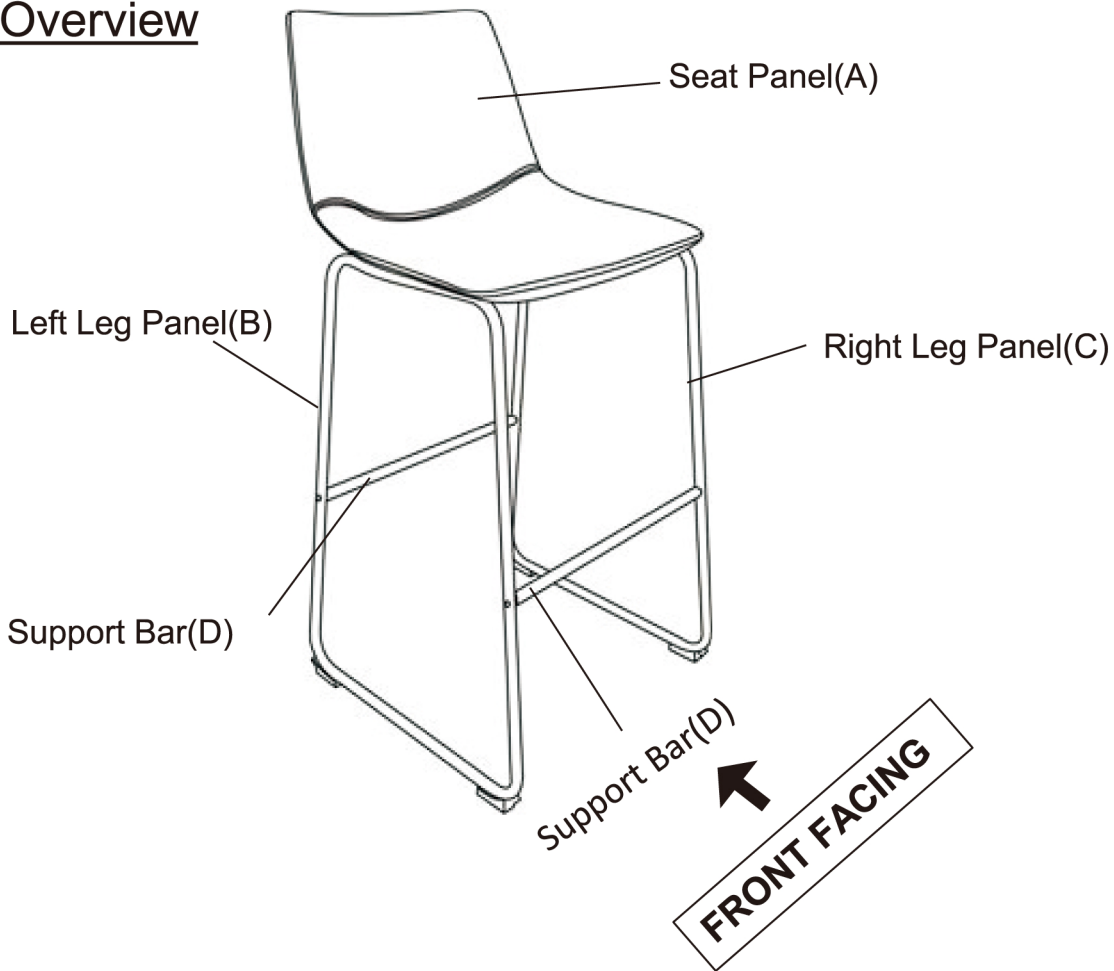

This Bar Stool has multiple parts and may require up to some 30 minutes to assemble. To give you an overview of the Bar Stool parts, the above picture is to help you put the various parts into perspective. Please read through the instructions below to familiarise yourself with the parts and steps before assembly.

Step 1

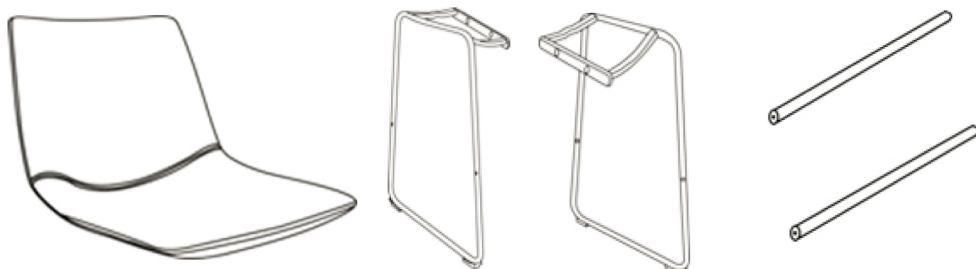

Unpack and place all parts on a clean, non-marring surface.

Step 2

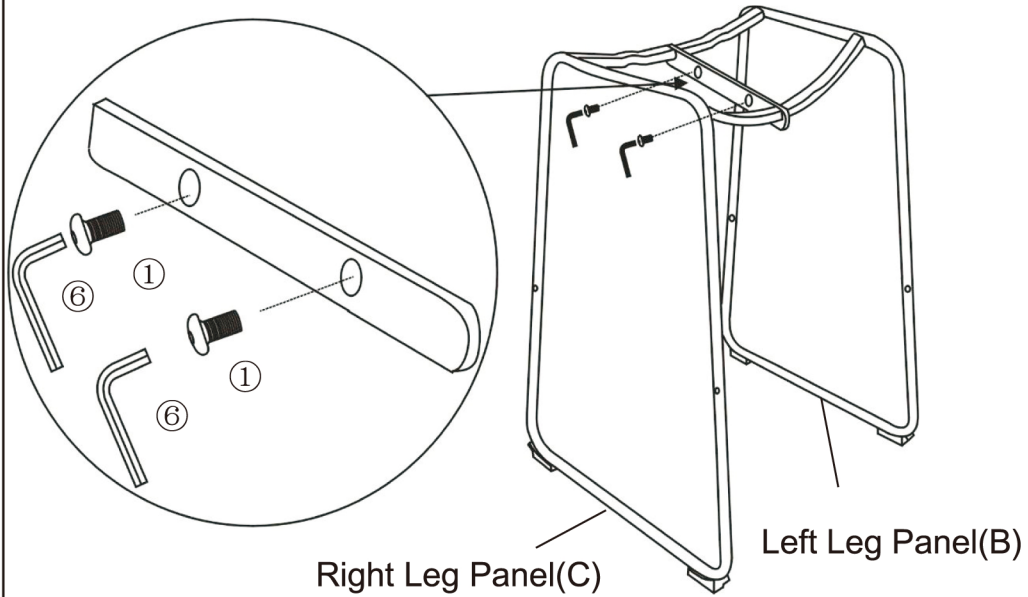

Align Left Leg Panel(B) with Right Leg Panel(C) as shown in the picture.
Attach Left Leg Panel(B) to Right Leg Panel(C) using Short Bolts(①) with Allen Key(⑥).

Do not fully tighten the Bolts.

Step 3

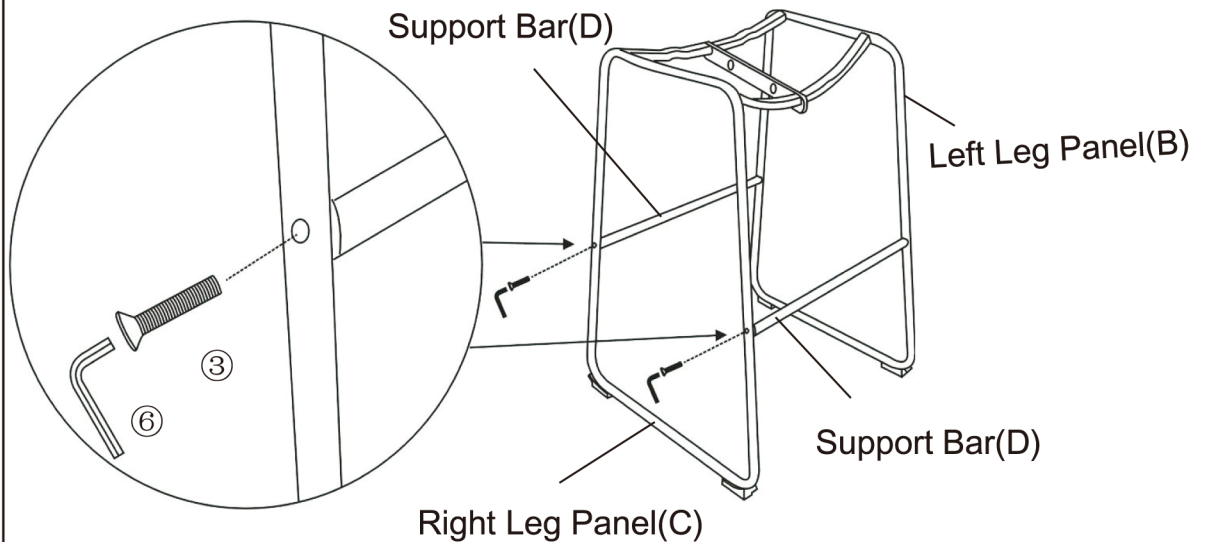

Then place Support Bars(D) between Right Leg Panel(C) and Left Leg Panel(B) as shown in picture above.

Attach Support Bars(D) to Right Leg Panel(C) and Left Leg Panel(B) using Long Bolts(③) with Allen Key(⑥).

Do not fully tighten the Bolts.

Step 4

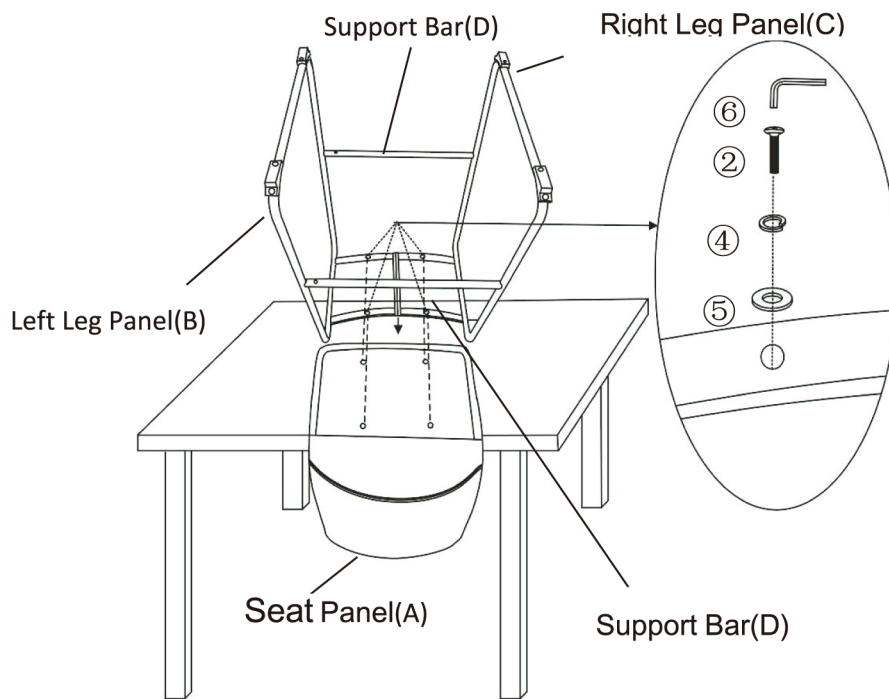

With the help from your partner, place the Seat Panel(A) facedown. Align the Left Leg Panel(B) and Right Leg Panel(C) with Seat Panel(A). Attach using Middle Bolts(②), Spring Washers(④), and Washers(⑤) with Allen Key(⑥).





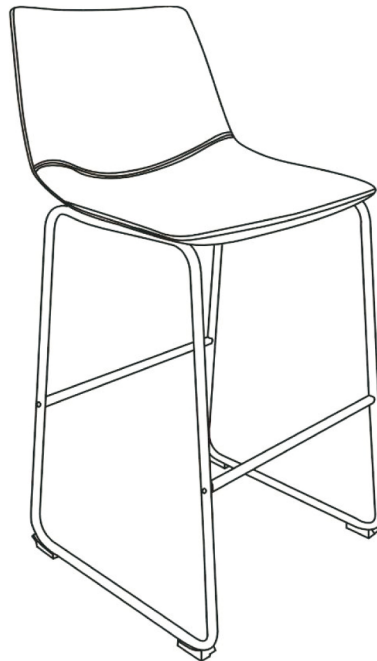













Tighten all Bolts at all joints in a sequential manner until secure.

Step 5



Your Bar Stool is ready for use.
This Bar Stool can only be used on a flat, level surface.

Care & Maintenance

-   ● Do not put hot items directly on furniture surface
 -   ● Do not clean furniture with harsh cleansers or polish.
 -   ● Do not place furniture under direct sunlight.
 -   ● Do not place furniture near heating or cooling vents.
 -   ● Do not write on furniture without a padded barrier to protect the surface.
 -   ● Do not place furniture outside . For indoor use only .
 -   ● Not for commercial use. For residential use only .
 -   ● Stains may be removed with mild soap solution and damp cloth.
 -   ● Children should not climb or jump on the furniture.
-
-   ● Dust and pick-up spills using a clean, non-colored, lint-free cloth .