

# Assembly Instructions

**Caution: You must read Assembly Instruction before you proceed.**

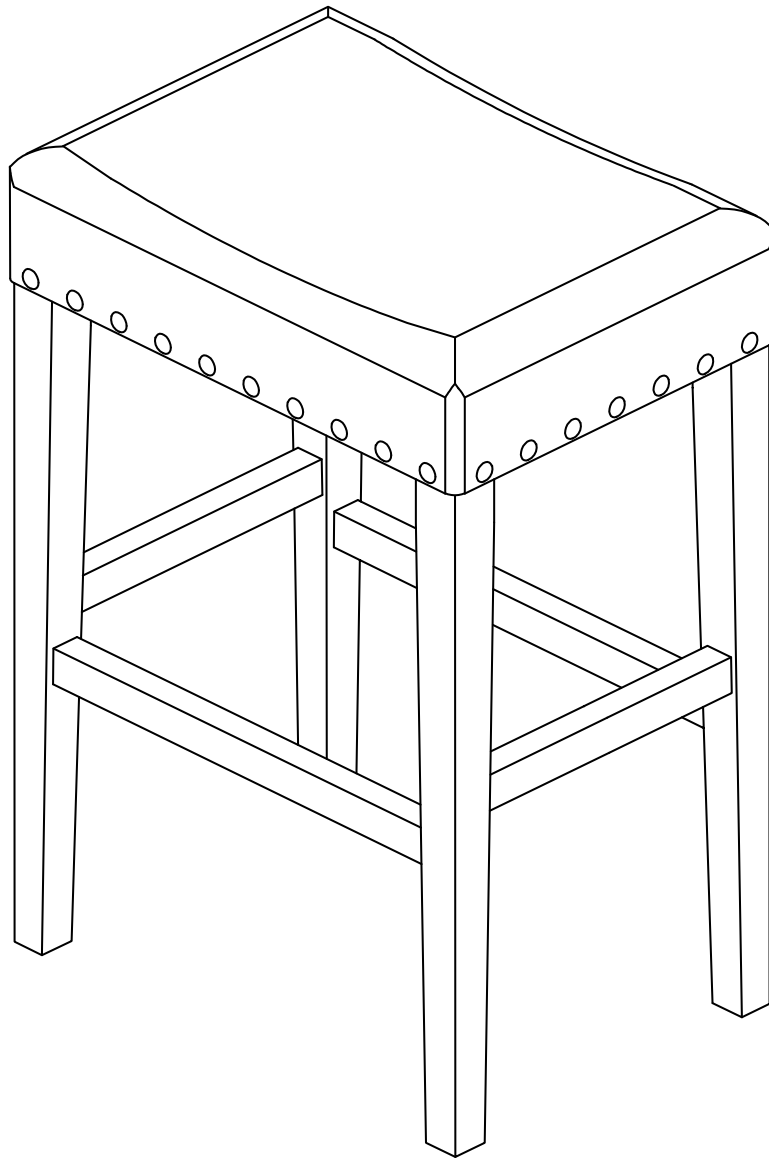



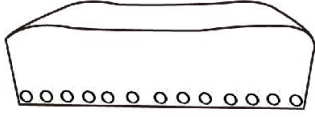
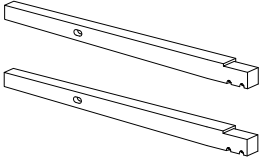
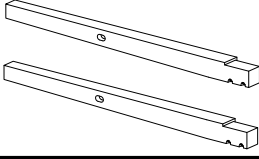
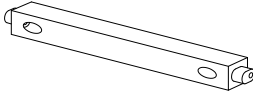
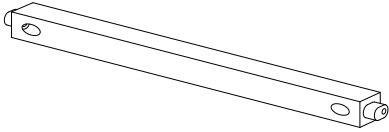

## Bar Stool

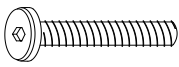

# Parts List

Part NO.	Picture	Description	QTY
A		Seat	1 PC
B		Right Leg	2 PCS
C		Left Leg	2 PCS
D		Short Side Rail	2 PCS
E		Long Side Rail	2 PCS

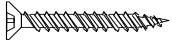
# Hardware

Label	Picture	Description	QTY
①		Bolt (M8 x 55mm)	9 PCS
②		Spring Washer (Φ8.5 x Φ13.5mm)	9 PCS
③		Washer (Φ8.5 x Φ22mm)	9 PCS
④		Allen Wrench	1 PC
⑤		Screw (M4 x 50mm)	9 PCS
⑥		Screwdriver	Not provided

# Assembly Preparation

Before Beginning Assembly:

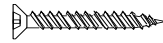
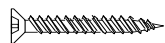
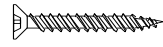
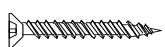
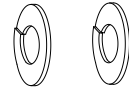
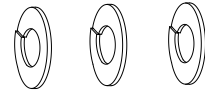
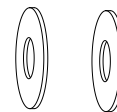
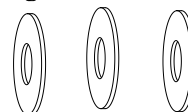
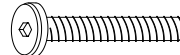
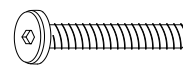
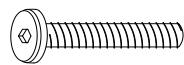
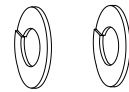
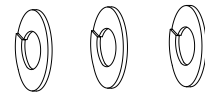
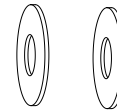
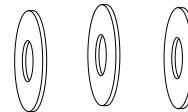
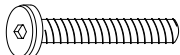
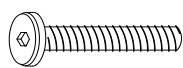
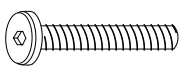
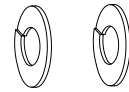
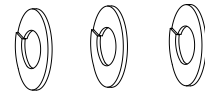
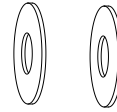
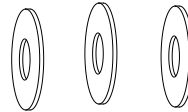
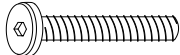
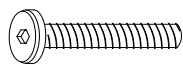
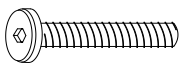
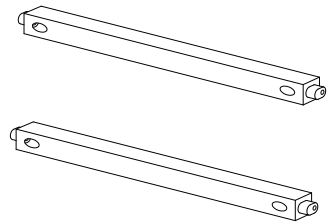
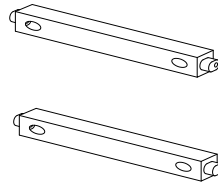
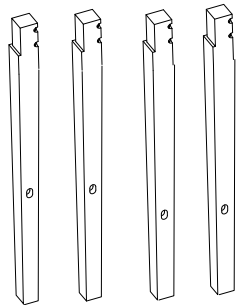
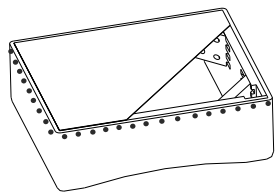

- Read instructions, cover to cover-



- Have 2 adults on hand for assembly-



- Do not assemble on flooring or carpet-



- Assemble on a clean non-marring surface (packing foam)-



- Save all packaging until finished-

# Assembly Steps

## Step 1

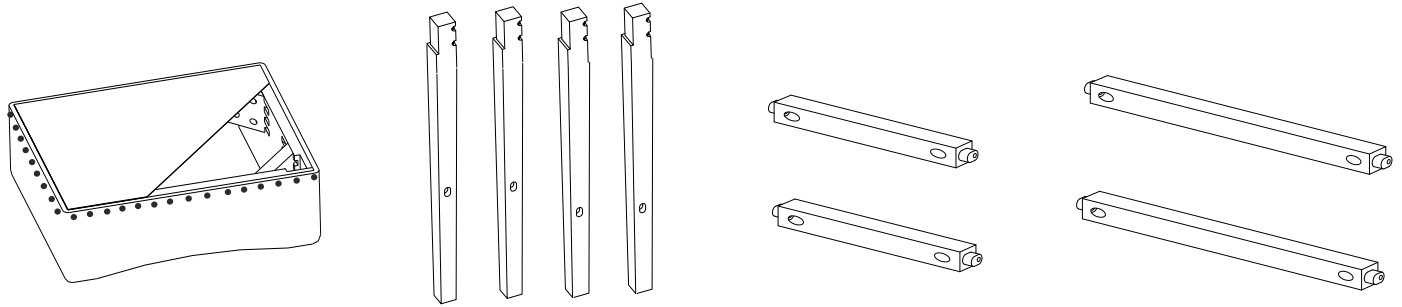

Unpack and place all parts on a clean, non-marring surface.

## Step 2

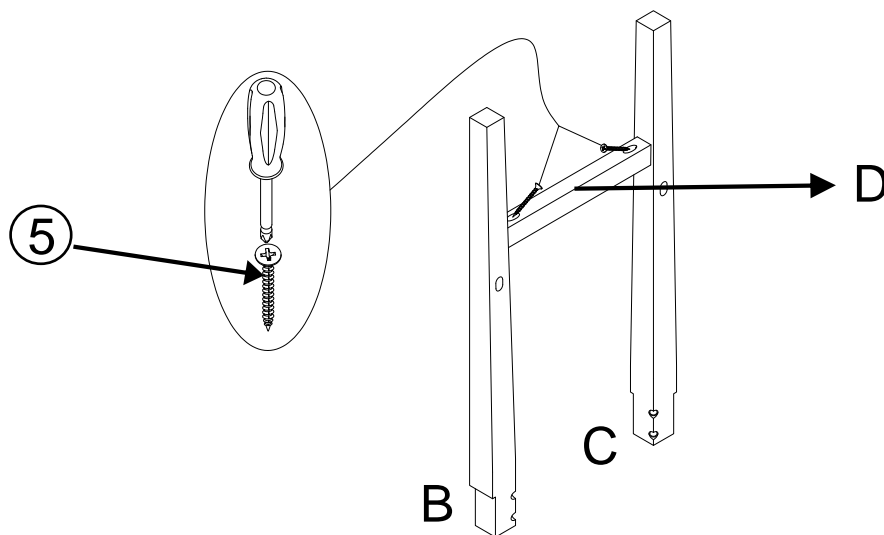

Insert the Short Side Rail (D) into the oval holes of Legs (B,C) forming an 'H' frame by using Screws (⑤) and Screwdriver as shown above.

Repeat the same process with remain Short Side Rail (D) and Legs (B,C).

**DO NOT OVER TIGHTEN**

### Step 3

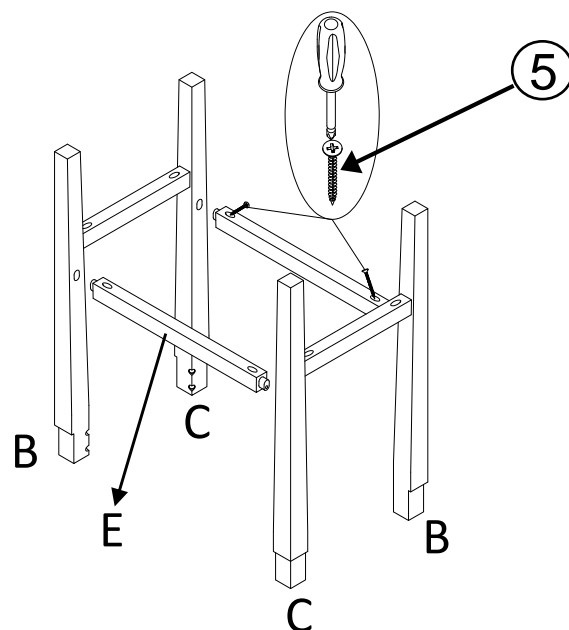

Insert the Long Side Rails (E) into the oval holes of the 'H' leg frame in Step 2 by using Screws (5) and Screwdriver as shown above.

**WARNING !! DO NOT OVER TIGHTEN. OVER TIGHTENING COULD LEAD TO DAMAGE OF THE PRODUCT. TIGHTEN ONLY UNTIL SECURE**

### Step 4

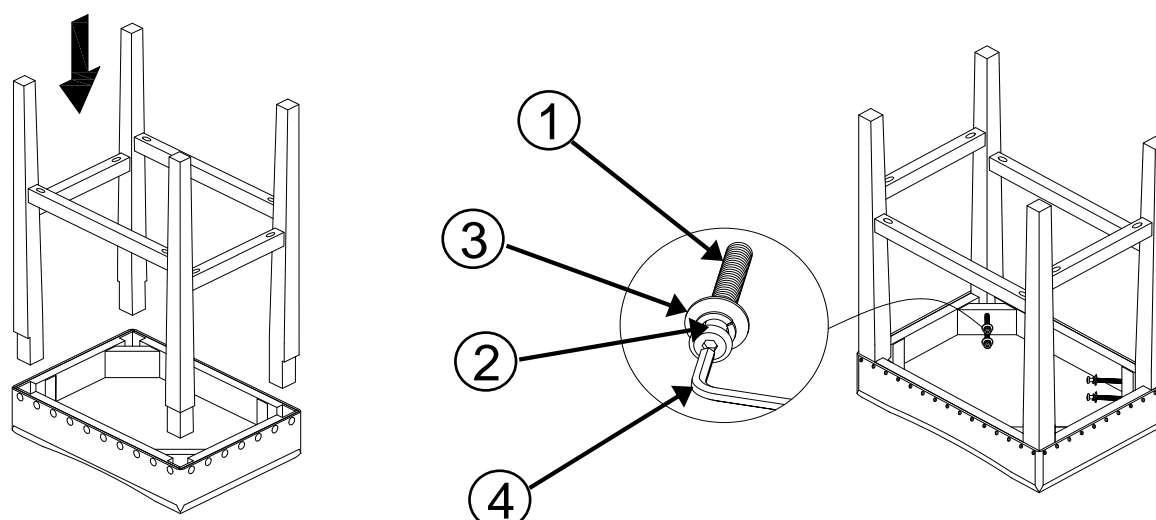

Place the Seat (A) onto a soft and clean surface to avoid any scratches or damages to the product.

Connect the Frame on Step 3 to the Seat (A) then secure by using Bolt (1), Spring Washer (2), Washer (3), and Allen Wrench (4) as shown above.

**WARNING!! DO NOT OVER TIGHTEN. OVER TIGHTENING COULD LEAD TO DAMAGE OF THE PRODUCT. TIGHTEN ONLY UNTIL SECURE.**

## **Step 5**

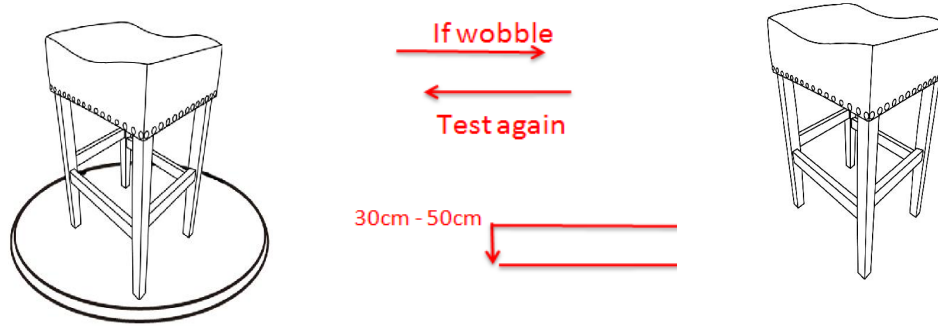

Place the Barstool on a **LEVEL SURFACE** to see if it wobbles.

If it wobbles, lift the Barstool to some 30cm to 50cm height from the ground. Keep your feet and toes well away from the drop zone.

Drop the Barstool freely and vertically with the four legs, hitting the ground at the same time.

This Drop Test will help to ensure that all the bolts and gaps, to all reach full alignment status.

Test again for evenness on a **LEVEL SURFACE**.

**IF NO WOBBLES FOUND, PROCEED TO TIGHTEN ALL THE BOLTS AND SCREWS**

**CAUTION** : When tightening these Bolts and Screws, tighten sequentially.

**DO NOT** tighten any Bolt and Screw fully and then towards the next one.

This would cause the frame to warp.

If there is still wobbles, loosen the Bolts and Screws and execute this same drop tests.

**WARNING!! IF BARSTOOL IS NOT STABLE , IT COULD LEAD TO DAMAGING THE PRODUCT.**

## **Step 6**

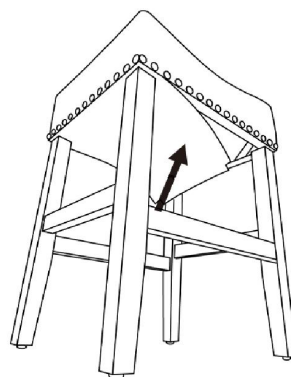











Place the Seat Base Cover Back underneath the Barstool Seat (as shown in picture) from where it was originally removed from.

Smooth down the 4 velcro edges with your hand.

The bar/ counter stool is now ready for use.

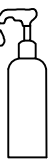
## Care & Maintenance

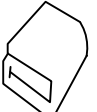
- ✓  ● Furniture may scratch floors. we recommend using furniture pads to protect your floors.
- ⊘  ● Do not put hot items directly on furniture surface.
- ⊘  ● Do not clean furniture with harsh cleansers or polish.
- ⊘  ● Do not place furniture under direct sunlight.
- ⊘  ● Do not place furniture near heating or cooling vents.
- ⊘  ● Do not write on furniture without a padded barrier to protect the surface.
- ⊘  ● Do not place furniture outside . For indoor use only.
- ⊘  ● Not for commercial use. For residential use only.
- ⊘  ● Stains may be removed with mild soap solution and damp cloth.
- ⊘  ● Children should not climb or jump on the furniture.
- ✓  ● Dust and pick-up spills using a clean, non-colored, lint-free cloth.